

Quick Installation Guide

US Series Hybrid Inverter

1. Packing List

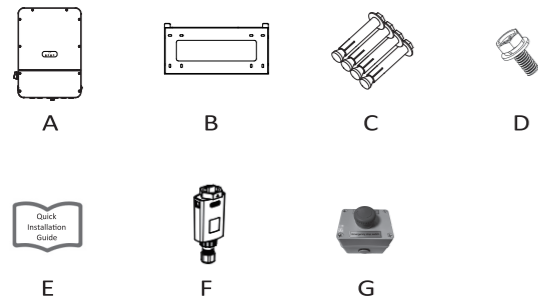

OBJ	QTY	DESC	OBJ	QTY	DESC
A	1	Inverter	E	1	Quick Installatoin Guide
B	1	Bracket	F	1	Smart WiLAN/GPRS (Optional)
C	4	Blot Sockets	G	1	E-STOP
D	1	Set Screw			

2. Installation Steps

Inverter Installation

Please make sure the inverter will be installed with a proper distance as shown below.

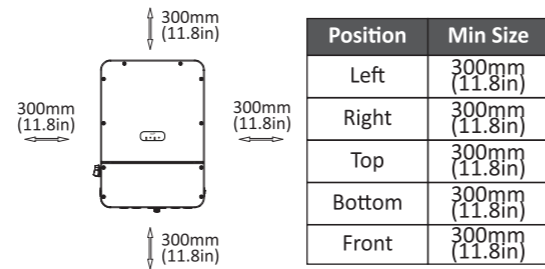

Step 1: Fix the bracket on the wall

Choose the place on which you want to install the inverter. Place the bracket on the wall and mark the position of the 4 holes from bracket.

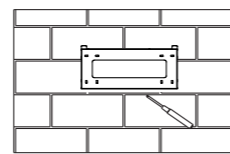

Drill holes with an electric drill, and make sure the holes are at least 50mm deep.

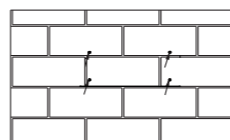

Hang the bracket on the wall, insert the blot sockets, and tighten them.

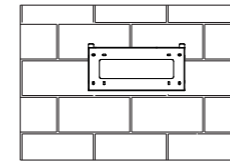

Step 2: Match the inverter with wall bracket

Hang the inverter over the bracket, slightly lower the inverter, and make sure the two mounting grooves on the back are properly fixed with the two bracket bars.

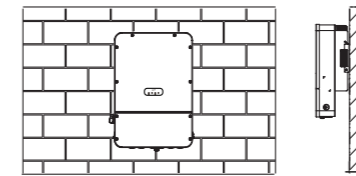

Tighten the anti-theft screw.

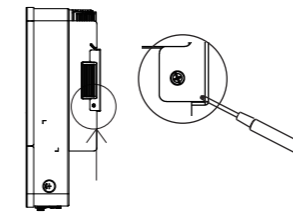

3. Wiring Steps

System Wiring Diagram

Whole-Home Backup

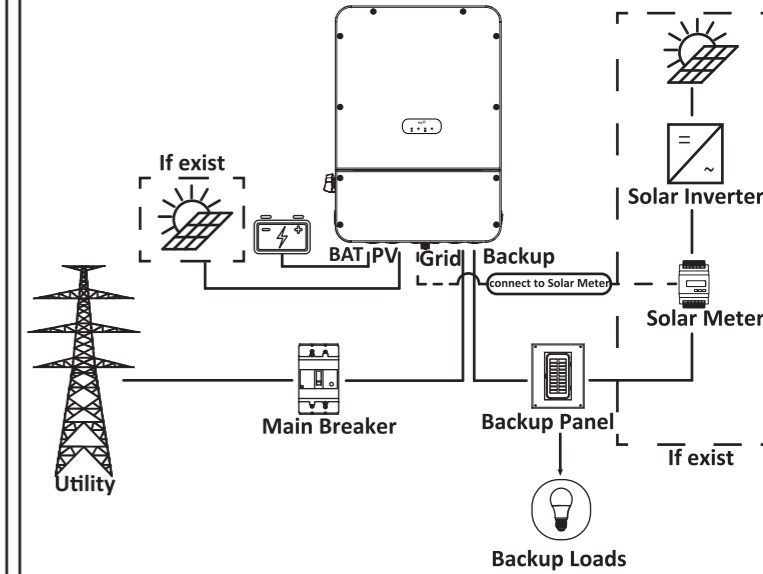

Partial-Home Backup

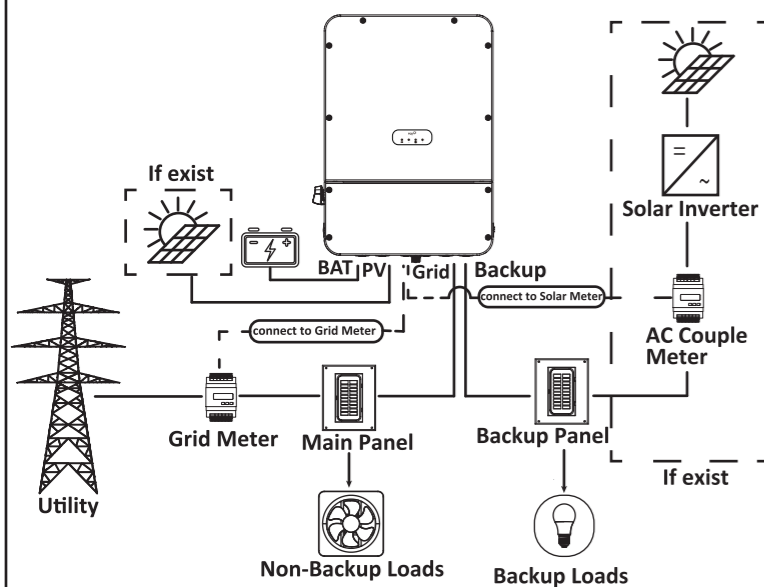

PV Wiring

- Turn off the DC switch.
 - Choose 10 AWG copper cable to connect the PV module.
 - Trim 12 mm of insulation from the cable end.
-
- Connect the PV module via the above copper cable as below.

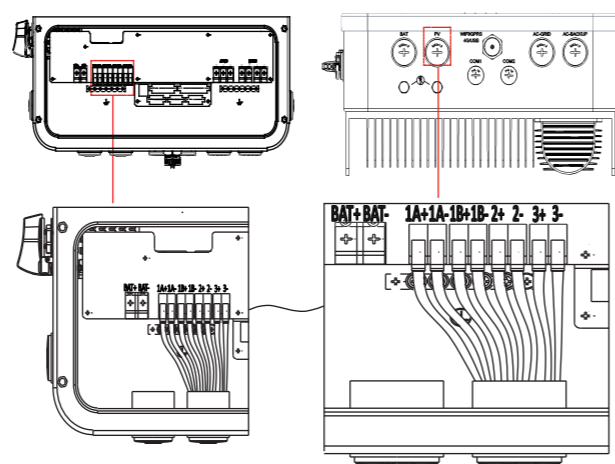

Inverter

AC-GRID Wiring

- Choose 6 AWG copper cable to connect the AC-GRID module.
 - Trim 12 mm of insulation from the cable end.
-
- Connect the AC-GRID module via the above copper cable as below.

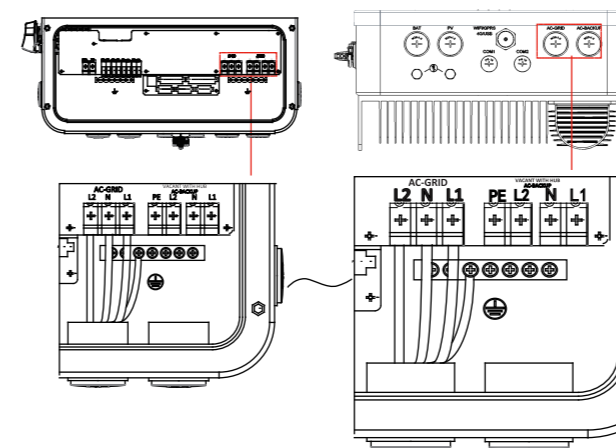

Inverter

AC-BACKUP Wiring

- Choose 6 AWG copper cable to connect the AC-BACKUP module.
 - Trim 12 mm of insulation from the cable end.
-
- Connect the AC-BACKUP module via the above copper cable as below.

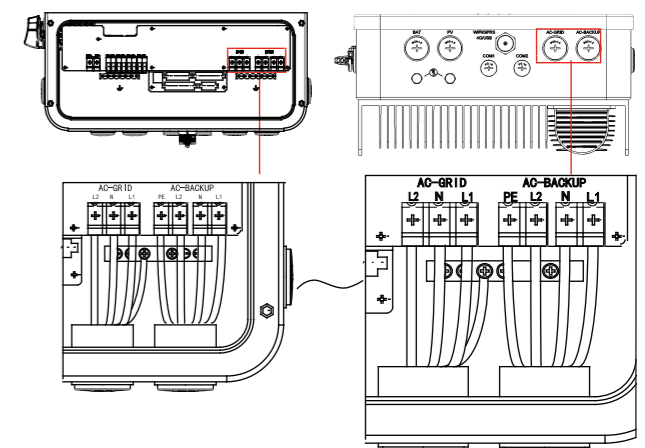

Inverter

Battery Wiring

- Choose 6 AWG copper cable to connect the battery module.
- Trim 12 mm of insulation from the cable end.

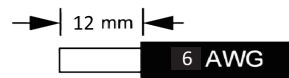

- Connect the battery module via the above copper cable as below.

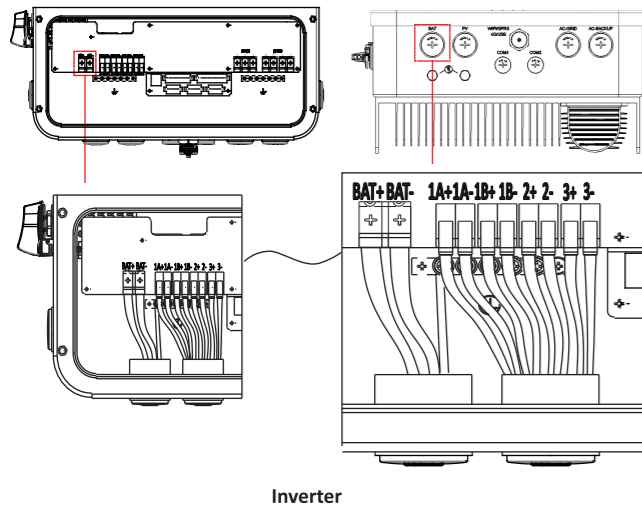

9

Inverter

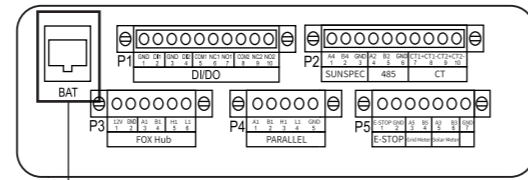
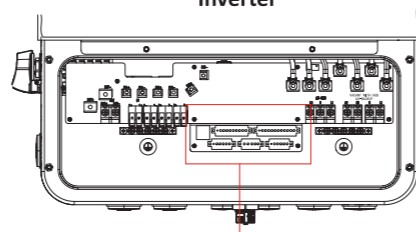

Communication Cable



Battery

10

Meter Wiring

- Grid Meter Wiring (Only for Partial-Home Backup)

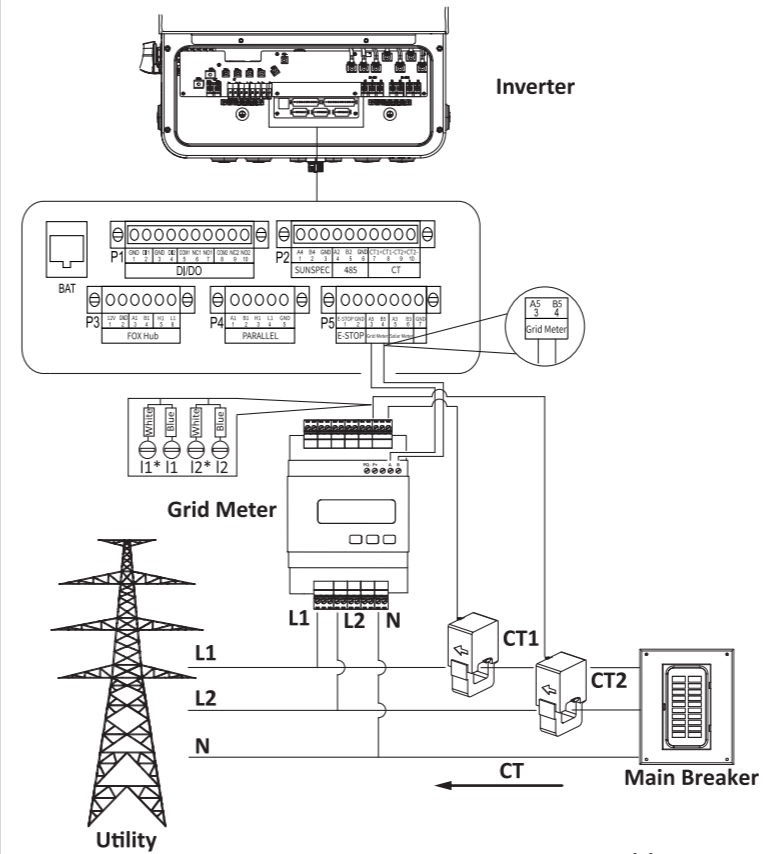

11

- Solar Meter Wiring (Optional)

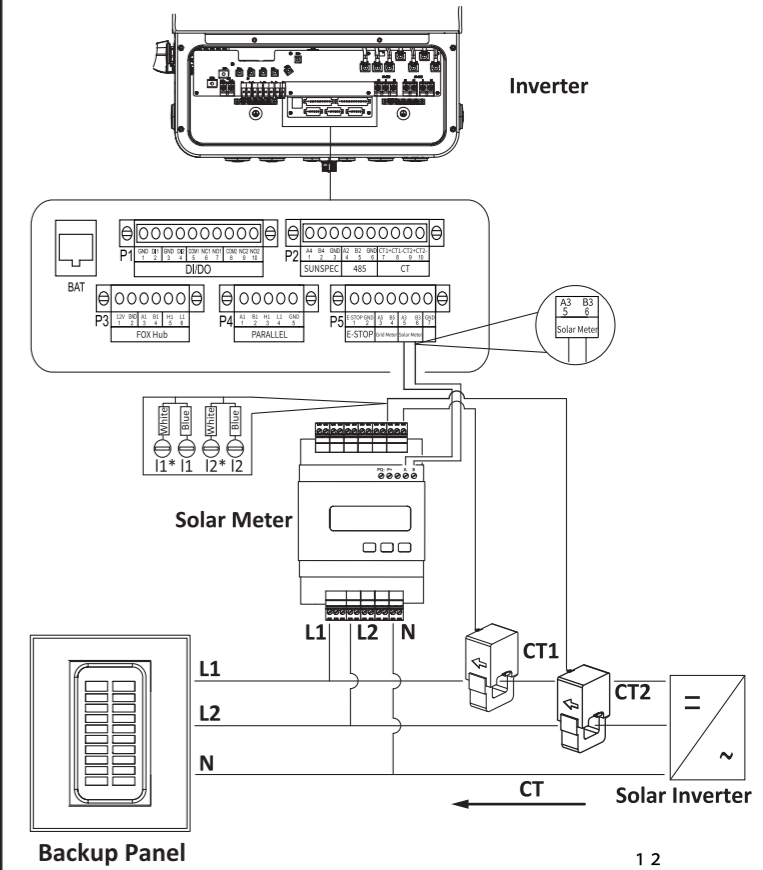

12

E-STOP Wiring Diagram

Inverter

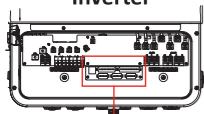

E-STOP

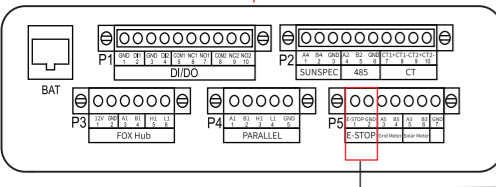
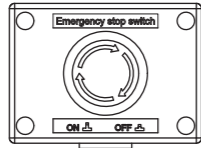

Warning: do not remove the protection wire at the P5 module of the AC adaptor if E-STOP is not used.

13

Smart WiLAN Connection (Optional)

- WIFI Connection: connect the Smart WiLAN to the inverter.

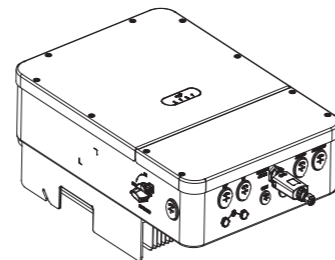

- Network Cable Connection: insert the network cable into the Smart WiLAN, and connect the Smart WiLAN to the inverter.

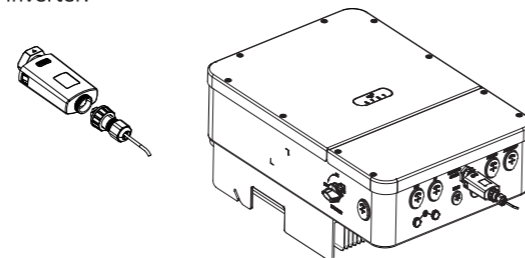

14

4. Inverter Switch On

Please refer to the following steps to switch on the inverter.

1. Ensure the inverter is fixed properly on the wall.
2. Ensure all cables are connected properly.
3. Ensure the meter and external off-grid contactor are connected properly (if needed).
4. Ensure the battery and E-STOP wires are connected properly.
5. Turn on the PV/DC switch, AC breaker, and off-grid breaker.

Note: • When starting the inverter for the first time, the country code will be set by default to the local settings. Check if the country code is correct.

- Set the time on the inverter using the APP.

15

5. Inverter Switch Off

Please refer to the following steps to switch off the inverter.

1. Turn off the battery switch, the PV/DC switch, AC breaker, and off-grid breaker.
2. Wait 5 min before you open the upper cover (in case of repair).

The document will be updated frequently. For the latest version, please scan the QR code for the latest version.



16