

# User Manual

## Fox PowerQ Energy Storage System

FOXESS CO., LTD.



**Copyright © FOXESS CO., LTD. 2023. All rights reserved.**

Without the prior written permission of FOXESS CO., LTD., this manual cannot be reproduced, distributed, or displayed in any form.

**Notice**

Please keep this manual where it will be accessible at all times. The information in this document is subject to change without notice. Every effort has been made in the preparation of this document to ensure accuracy of the contents, but all statements, information, and recommendations in this document do not constitute a warranty of any kind, express or implied.

This manual is intended for use by qualified electricians. The tasks described in this manual only can be performed by qualified electricians.

Please read this document carefully before installing or using the Fox PowerQ energy storage system. Failure to follow any instructions or warnings in this document may result in damage to the equipment, personal electric shock, severe injury, or even death.

**Table of Contents**

1 Safety Statements ..... 2

    1.1 Important Information ..... 2

    1.2 Symbols Used ..... 2

    1.3 Appropriate Usage ..... 2

        1.3.1 Unpacking and Inspection ..... 4

        1.3.2 Package Safety ..... 5

        1.3.3 Electrical Connection Safety ..... 7

        1.3.4 Operation Safety ..... 8

        1.3.5 Maintenance Safety ..... 9

        1.3.6 Disposal Safety ..... 10

    1.4 PE Connection and Leakage Current ..... 10

2 System Overview ..... 12

    2.1 Specifications ..... 12

        2.1.1 Fox PowerQ Specification ..... 12

        2.1.2 FOX Hub G2 Specification ..... 42

    2.2 System Installation ..... 44

        2.2.1 System Installation Space ..... 44

        2.2.2 Installation Steps ..... 45

        2.2.3 Installing FOX Hub G2 as Service Panel or not as Service Panel ..... 46

    2.3 Backup Options ..... 49

    2.4 Operating Mode ..... 55

    2.5 Key Functions ..... 56

3 LED Lightening Descriptions ..... 58

4 System Remote Operation and Monitoring ..... 62

5 Service and Maintenance ..... 63

    5.1 Troubleshooting ..... 63

    5.2 Service and Maintenance ..... 75

6 Decommissioning ..... 76

    6.1 Dismantling the Fox PowerQ energy storage system ..... 76

    6.2 Packaging ..... 76

    6.3 Storage and Transportation ..... 76

7 Appendix 1: Three-line Diagrams (1 FOX Hub G2+1 Fox PowerQ Unit)..... 77

8 Appendix 2: Three-line Diagrams (1 FOX Hub G2+Parallel Fox PowerQ Units)..... 85





# 1 Safety Statements

## 1.1 Important Information

The devices in the Fox PowerQ energy storage system are electrical devices. Please read this entire document to ensure the proper use of the Fox PowerQ energy storage system. Failure to follow this may void the warranty. Please strictly follow the safety instructions in this manual during operation, otherwise it may result in equipment malfunction, electrical shock, series injury or death.







## 1.2 Symbols Used

This section explains the symbols shown on the device and on the type label:

	<p><b>Danger!</b></p> <p>"Danger" indicates a hazardous situation which, if not avoided, will result in death or serious injury.</p> <p><b>Danger!</b></p> <p>"Danger" indique une situation dangereuse qui, si elle n'est pas évitée, entraînera la mort ou des blessures graves.</p>
	<p><b>Warning!</b></p> <p>"Warning" indicates a hazardous situation which, if not avoided, could result in death or serious injury.</p> <p><b>Avertissement!</b></p> <p>"Avertissement" indique une situation dangereuse qui, si elle n'est pas évitée, pourrait entraîner la mort ou des blessures graves.</p>
	<p><b>Caution!</b></p> <p>"Caution" indicates a hazardous situation which, if not avoided, could result in minor or moderate injury.</p> <p><b>Attention!</b></p> <p>"Attention" indique une situation dangereuse qui, si elle n'est pas évitée, pourrait entraîner des blessures mineures ou modérées.</p>
	<p><b>Note!</b></p> <p>"Note" provides important tips and guidance.</p> <p><b>Remarque!</b></p> <p>"Remarque" fournit des conseils et des indications importants.</p>



This section explains the symbols shown on the inverter and on the type label:

Symbols	Explanation
	<p>Certified to meet the requirements of CSA-C22.2 No. 107.1-16, UL Std. No. 1741-Third Edition, UL 1741 SB, IEEE 1547-2018, IEEE 1547.1-2020, and CA Rule 21.</p> <p>Certifié conforme aux exigences de CSA-C22.2 No. 107.1-16, UL Std. No. 1741-Troisième édition, UL 1741 SB, IEEE 1547-2018, IEEE 1547.1-2020 et CA Rule 21.</p>

	<p>Beware of burning.</p> <p>The case temperature may exceed 140°F (60°C) during operation. Avoid contact during operation.</p> <p>Attention aux brûlures.</p> <p>La température du boîtier peut dépasser 60°C (140°F) pendant le fonctionnement. Évitez tout contact pendant le fonctionnement.</p>
	<p>Danger of high voltages.</p> <p>Disconnect from the grid and the PV generator before opening the device.</p> <p>Danger de tensions élevées.</p> <p>Déconnectez l'appareil du réseau et du générateur PV avant d'ouvrir le dispositif.</p>
	<p>Danger.</p> <p>Risk of electric shock!</p> <p>Danger.</p> <p>Risque de choc électrique!</p>
	<p>Danger to life due to high voltage.</p> <p>There is residual voltage in the inverter which needs 5 min to discharge.</p> <p>Wait 5 min before you open the upper cover or the lower cover.</p> <p>Danger de mort en raison de la haute tension.</p> <p>Il y a une tension résiduelle dans l'onduleur qui nécessite 5 minutes pour se décharger. Attendez 5 minutes avant d'ouvrir le couvercle supérieur ou le couvercle inférieur.</p>
	<p>Read the manual.</p> <p>Lisez le manuel.</p>
	<p>Product should not be disposed as household waste.</p> <p>Le produit ne doit pas être jeté avec les déchets ménagers.</p>
	<p>This device complies with part 15 of the FCC Rules. Operation is subject to the following conditions: (1) this device may not cause harmful interference, and (2) this device must accept any interference received, including interference that may cause undesired operation.</p> <p>Cet appareil est conforme à la partie 15 des règles de la FCC. Son fonctionnement est soumis aux conditions suivantes : (1) Cet appareil ne doit pas causer d'interférences nuisibles, et (2) cet appareil doit accepter toute interférence reçue, y compris les interférences susceptibles de provoquer un fonctionnement indésirable.</p>

## 1.3 Appropriate Usage

The Fox PowerQ energy storage system is designed and tested in accordance with international safety requirements. However, certain safety precautions must be taken into account when installing and operating this system. The installer must read and follow all instructions, cautions, and warnings in this manual.



	<p><b>Warning!</b></p> <ul style="list-style-type: none"> <li>• It is strictly prohibited to operate the product (including, but not limited to, handling, installation, electrical connection, powering up, maintenance, working at height, etc.) in bad weather, such as thunder, lightning, rain, snow, or winds of more than force six grades.</li> <li>• In case of fire, evacuate the building or product area and call the fire alarm. In any case, re-entry into the burning area is strictly prohibited.</li> </ul> <p><b>Avertissement!</b></p> <ul style="list-style-type: none"> <li>• Il est strictement interdit d'utiliser le produit (y compris, mais sans s'y limiter, la manipulation, l'installation, le raccordement électrique, la mise sous tension, l'entretien, le travail en hauteur, etc.) en cas de mauvais temps, tel que les orages, la foudre, la pluie, la neige, ou des vents de plus de six degrés.</li> <li>• En cas d'incendie, évacuez le bâtiment ou la zone du produit et déclenchez l'alarme incendie. Dans tous les cas, le ré-accès à la zone en feu est strictement interdit.</li> </ul>
	<p><b>Note!</b></p> <ul style="list-style-type: none"> <li>• All operations including transport, installation, start-up, and maintenance, must be carried out by qualified, trained personnel.</li> <li>• The electrical installation &amp; maintenance of the equipment shall be conducted by a licensed electrician and shall comply with local wiring rules and regulations.</li> <li>• Please operate the equipment under the condition that you are familiar with and understand the contents of this manual and have the appropriate tools.</li> </ul> <p><b>Remarque!</b></p> <ul style="list-style-type: none"> <li>• Toutes les opérations, y compris le transport, l'installation, la mise en service et la maintenance, doivent être effectuées par du personnel qualifié et formé.</li> <li>• L'installation électrique et la maintenance de l'équipement doivent être effectuées par un électricien agréé et doivent respecter les règles et réglementations locales en matière de câblage.</li> <li>• Veuillez utiliser l'équipement uniquement si vous êtes familier avec le contenu de ce manuel et que vous en comprenez les instructions, et si vous disposez des outils appropriés.</li> </ul>



### 1.3.1 Unpacking and Inspection

	<p><b>Note!</b></p> <ul style="list-style-type: none"> <li>• Check all safety signs, warning labels and nameplates on the product.</li> <li>• Safety markings, warning labels and nameplates must be clearly visible and</li> </ul>
---	---

	<p>not be removed or covered before the product is scrapped.</p> <ul style="list-style-type: none"> <li>• Upon receipt of the product, check the appearance of the product and components for damage, check whether the product received is consistent with the actual product ordered, if there is a problem with the above check items, please do not install and contact Fox ESS.</li> </ul> <p><b>Remarque!</b></p> <ul style="list-style-type: none"> <li>• Vérifiez tous les panneaux de signalisation de sécurité, les étiquettes d'avertissement et les plaques signalétiques sur le produit.</li> <li>• Les marquages de sécurité, les étiquettes d'avertissement et les plaques signalétiques doivent être clairement visibles et ne doivent pas être retirés ou recouverts avant que le produit ne soit mis au rebut.</li> <li>• À réception du produit, vérifiez l'apparence du produit et des composants pour détecter d'éventuels dommages, vérifiez si le produit reçu est conforme au produit réel commandé. S'il y a un problème avec les éléments de vérification mentionnés ci-dessus, veuillez ne pas procéder à l'installation et contacter Fox ESS.</li> </ul>
--	--

### 1.3.2 Package Safety



	<p><b>Danger!</b></p> <ul style="list-style-type: none"> <li>• Make sure the product is free of any electrical connections before installation.</li> <li>• When installing, if drilling is required, make sure you have avoided the pipeline and electric wire in the wall.</li> </ul> <p><b>Danger!</b></p> <ul style="list-style-type: none"> <li>• Assurez-vous que le produit est déconnecté de toute source d'électricité avant l'installation.</li> <li>• Lors de l'installation, si des trous doivent être percés, assurez-vous d'éviter les conduites et les câbles électriques présents dans le mur.</li> </ul>
	<p><b>Warning!</b></p> <ul style="list-style-type: none"> <li>• Before installation, check the unit to ensure it is free of any transport or handling damage, which could affect insulation integrity or safety clearances. Choose the installation location carefully and adhere to specified cooling requirements. Unauthorized removal of necessary protections, improper use, incorrect installation, and operation may lead to serious safety and shock hazards or equipment damage.</li> <li>• Any time the equipment has been disconnected from the public network, please be extremely cautious as some components can retain charge sufficient to create a shock hazard. Prior to touching any part of the equipment please ensure surfaces and equipment are under touch with safe temperatures and voltage potentials before proceeding.</li> </ul> <p><b>Avertissement!</b></p> <ul style="list-style-type: none"> <li>• Avant l'installation, vérifiez l'unité pour vous assurer qu'elle est exempte de tout dommage causé par le transport ou la manipulation, pouvant affecter l'intégrité de l'isolation ou les distances de sécurité. Choisissez soigneusement l'emplacement d'installation et respectez les exigences</li> </ul>

	<p>spécifiées en matière de refroidissement. Le retrait non autorisé des protections nécessaires, une utilisation incorrecte, une installation incorrecte et un fonctionnement peuvent entraîner des risques sérieux pour la sécurité et des dangers de choc électrique ou des dommages à l'équipement.</p> <ul style="list-style-type: none"> <li>• À chaque fois que l'équipement est déconnecté du réseau public, veuillez faire preuve d'une extrême prudence car certains composants peuvent conserver suffisamment de charge pour créer un danger de choc électrique. Avant de toucher une partie de l'équipement, assurez-vous que les surfaces et l'équipement sont à des températures sûres et à des potentiels de tension avant de continuer.</li> </ul>
	<p><b>Caution!</b></p> <ul style="list-style-type: none"> <li>• If the product supports lifting and handling methods and needs to be lifted by heavy tools, it is prohibited for people to pass or stay underneath the product.</li> <li>• When handling the product, please consider the weight of the product and take care to maintain balance to prevent the product from tipping or falling.</li> </ul> <p><b>Attention!</b></p> <ul style="list-style-type: none"> <li>• Si le produit prend en charge des méthodes de levage et de manutention et doit être soulevé à l'aide d'outils lourds, il est interdit aux personnes de passer ou de rester en dessous du produit.</li> <li>• Lors de la manipulation du produit, veuillez tenir compte du poids du produit et prendre soin de maintenir l'équilibre pour éviter que le produit ne bascule ou ne tombe.</li> </ul>
	<p><b>Note!</b></p> <ul style="list-style-type: none"> <li>• Before handling the product, always check to make sure that the tools you are using have been regularly maintained.</li> <li>• Before connecting the equipment to the power distribution grid, contact the local power distribution grid company to get appropriate approvals. This connection must be made only by qualified technical personnel.</li> <li>• Do not install the equipment in adverse environmental conditions such as in close proximity to flammable or explosive substances; in a corrosive environment; where there is exposure to extremely high or low temperatures; or where humidity is high.</li> <li>• Do not use the equipment when the safety devices do not work or are disabled.</li> <li>• Inform the manufacturer about non-standard installation conditions.</li> <li>• Use personal protective equipment, including gloves and eye protection during the installation.</li> </ul> <p><b>Remarque!</b></p> <ul style="list-style-type: none"> <li>• Avant de manipuler le produit, vérifiez toujours que les outils que vous utilisez ont été régulièrement entretenus.</li> <li>• Avant de raccorder l'équipement au réseau de distribution électrique, contactez la société locale de distribution électrique pour obtenir les autorisations appropriées. Ce raccordement ne doit être effectué que par du personnel technique qualifié.</li> </ul>



	<ul style="list-style-type: none"> <li>• N'installez pas l'équipement dans des conditions environnementales défavorables, telles que à proximité de substances inflammables ou explosives, dans un environnement corrosif, exposé à des températures extrêmement élevées ou basses, ou où l'humidité est élevée.</li> <li>• N'utilisez pas l'équipement lorsque les dispositifs de sécurité ne fonctionnent pas ou sont désactivés.</li> <li>• Informez le fabricant des conditions d'installation non standard. Utilisez des équipements de protection individuelle, tels que des gants et une protection oculaire, pendant l'installation.</li> </ul>
--	---

### 1.3.3 Electrical Connection Safety

	<p><b>Danger!</b></p> <ul style="list-style-type: none"> <li>• Before making electrical connections, make sure that the equipment is not damaged, otherwise it may be dangerous!</li> <li>• Always make sure that the equipment and all switches connected to it are disconnected before electrical connections are made, otherwise there is a risk of electric shock.</li> <li>• When making electrical connections, be sure to wear personal protective equipment and use special insulating tools.</li> <li>• Before touching a DC cable, always use a measuring device to ensure that the cable is not energized.</li> <li>• The equipment must not be connected to a PV string that requires positive or negative grounding.</li> </ul> <p><b>Danger!</b></p> <ul style="list-style-type: none"> <li>• Avant de faire des connexions électriques, assurez-vous que l'équipement n'est pas endommagé, sinon cela peut être dangereux!</li> <li>• Assurez-vous toujours que l'équipement et tous les commutateurs qui y sont connectés sont déconnectés avant les connexions électriques, sinon il y a un risque de choc électrique.</li> <li>• Lors de la réalisation de connexions électriques, veillez à porter des équipements de protection individuelle et à utiliser des outils isolants spéciaux.</li> <li>• Avant de toucher un câble CC, utilisez toujours un dispositif de mesure pour vous assurer que le câble n'est pas sous tension. L'équipement ne doit pas être connecté à une chaîne PV qui nécessite une mise à la terre positive ou négative.</li> </ul>
	<p><b>Warning!</b></p> <ul style="list-style-type: none"> <li>• Before supplying power, connect the ground wire.</li> <li>• Incorrect grounding can cause personal injury, death or equipment failure and increase electromagnetic interference.</li> <li>• Ensure that the size of the grounding wire meets the requirements of the safety regulations.</li> <li>• The cables used in the PV power system must be of suitable size, firmly connected and well insulated.</li> </ul>

	<ul style="list-style-type: none"> <li>• Before connecting the DC connector to the equipment, please check the positive and negative polarity of the PV string and insert the DC connector into the corresponding DC terminal.</li> <li>• During the installation and operation of the equipment, please make sure that the positive or negative pole of the PV string will not be shorted to ground. Otherwise, it may cause AC and DC short circuit of the equipment, resulting in product damage, and loss caused is not covered by the warranty.</li> </ul> <p><b>Attention!</b></p> <ul style="list-style-type: none"> <li>• Avant d'alimenter en électricité, connectez le fil de mise à la terre.</li> <li>• Une mise à la terre incorrecte peut causer des blessures, la mort ou la défaillance de l'équipement et augmenter les interférences électromagnétiques.</li> <li>• Assurez-vous que la taille du fil de mise à la terre répond aux exigences des réglementations de sécurité.</li> <li>• Les câbles utilisés dans le système électrique photovoltaïque doivent être de taille appropriée, solidement connectés et bien isolés.</li> <li>• Avant de connecter le connecteur CC à l'équipement, vérifiez la polarité positive et négative de la chaîne PV et insérez le connecteur CC dans la borne CC correspondante. Pendant l'installation et l'utilisation de l'équipement, assurez-vous que la polarité positive ou négative de la chaîne PV ne sera pas mise à la terre. Sinon, cela peut causer un court-circuit AC et DC de l'équipement, entraînant des dommages au produit, et la perte causée n'est pas couverte par la garantie.</li> </ul>
--	--

### 1.3.4 Operation Safety

When routing cables, ensure a distance of at least 30 mm between the cables and heat-generating components or areas to protect the insulation layer of cables from aging and damage.

	<p><b>Danger!</b></p> <ul style="list-style-type: none"> <li>• Do not touch the product enclosure.</li> <li>• It is strictly forbidden to plug and unplug any connector on the equipment.</li> <li>• Do not touch any wiring terminal of the equipment. Otherwise, electric shock may occur.</li> <li>• Do not disassemble any parts of the equipment. Otherwise, electric shock may occur.</li> <li>• It is strictly forbidden to touch any hot parts of the equipment (such as the heat sink). Otherwise, it may cause burns.</li> <li>• Do not connect or remove any PV string or any PV module in a string. Otherwise, electric shock may occur.</li> <li>• If the equipment is equipped with a DC switch, do not operate it. Otherwise, it may cause device damage or personal injury.</li> </ul> <p><b>Danger!</b></p> <ul style="list-style-type: none"> <li>• Ne touchez pas l'enceinte du produit.</li> <li>• Il est strictement interdit de brancher ou débrancher tout connecteur sur l'équipement.</li> </ul>
---	---

	<ul style="list-style-type: none"> <li>• Ne touchez aucun terminal de câblage de l'équipement. Sinon, un choc électrique peut se produire.</li> <li>• Ne démontez aucune partie de l'équipement. Sinon, un choc électrique peut se produire.</li> <li>• Il est strictement interdit de toucher toute partie chaude de l'équipement (comme le dissipateur de chaleur). Sinon, cela peut causer des brûlures.</li> <li>• Ne connectez ni ne retirez aucune chaîne PV ou aucun module PV dans une chaîne. Sinon, un choc électrique peut se produire.</li> <li>• Si l'équipement est équipé d'un commutateur CC, ne l'actionnez pas. Sinon, cela peut causer des dommages à l'appareil ou des blessures corporelles.</li> </ul>
--	--

### 1.3.5 Maintenance Safety

Risk of equipment damage or personal injury due to incorrect service!

	<p><b>Danger!</b></p> <ul style="list-style-type: none"> <li>• Before maintenance, disconnect the AC circuit breaker on the grid side and then the DC switch. If a fault that may cause personal injury or device damage is found before maintenance, disconnect the AC circuit breaker and wait until the night before operating the DC switch. Otherwise, a fire inside the product or an explosion may occur, causing personal injuries.</li> <li>• After the equipment is powered off for 15 minutes, measure the voltage and current with professional instrument. Only when there is no voltage nor current can operators who wear protective equipment operate and maintain the equipment.</li> <li>• Even if the equipment is shut down, it may still be hot and cause burns. Wear protective gloves before operating the equipment after it cools down.</li> <li>• The power grid side may generate voltage. Always use a standard voltmeter to ensure that there is no voltage before touching.</li> </ul> <p><b>Danger!</b></p> <ul style="list-style-type: none"> <li>• Avant toute opération de maintenance, déconnectez le disjoncteur AC côté réseau, puis le commutateur DC. Si une défaillance susceptible de causer des blessures corporelles ou des dommages aux appareils est constatée avant la maintenance, déconnectez le disjoncteur AC et attendez la nuit avant de manipuler le commutateur DC. Sinon, un incendie à l'intérieur du produit ou une explosion peut se produire, causant des blessures corporelles.</li> <li>• Après l'arrêt de l'équipement pendant 15 minutes, mesurez la tension et le courant avec un instrument professionnel. Seuls les opérateurs portant des équipements de protection peuvent opérer et entretenir l'équipement lorsque la tension et le courant sont nuls.</li> <li>• Même si l'équipement est éteint, il peut encore être chaud et causer des brûlures. Portez des gants de protection avant de manipuler l'équipement après qu'il ait refroidi. Le côté réseau peut générer une tension. Utilisez toujours un voltmètre standard pour vous assurer qu'il n'y a pas de tension avant de toucher.</li> </ul>
---	--

**Note!**

- Do not use the equipment if any operating anomalies are found. Avoid temporary repairs.
- All repairs should be carried out using only approved spare parts, which must be installed in accordance with their intended use and by a licensed contractor or authorized Fox ESS service representative.
- If the paint on the equipment enclosure falls or rusts, repair it in time. Otherwise, the equipment performance may be affected.
- Do not use cleaning agents to clean the equipment. Otherwise, the equipment may be damaged, and the loss caused is not covered by the warranty.
- As the equipment contains no parts that can be maintained, never open the enclosure of the equipment or replace any internal components without authorization. Otherwise, the loss caused is not covered by the warranty.
- To avoid the risk of electric shock, do not perform any other maintenance operations beyond those described in this manual. If necessary, contact Fox ESS. Otherwise loss caused is not covered by the warranty.

**Remarque!**

- N'utilisez pas l'équipement si vous constatez des anomalies de fonctionnement. Évitez les réparations temporaires.
- Toutes les réparations doivent être effectuées uniquement avec des pièces détachées approuvées, qui doivent être installées conformément à leur utilisation prévue et par un entrepreneur agréé ou un représentant de service autorisé Fox ESS.
- Si la peinture de l'enceinte de l'équipement se décolle ou rouille, réparez-la rapidement. Sinon, les performances de l'équipement peuvent être affectées.
- N'utilisez pas de produits de nettoyage pour nettoyer l'équipement. Sinon, l'équipement peut être endommagé et les pertes occasionnées ne sont pas couvertes par la garantie.
- Comme l'équipement ne contient aucune pièce pouvant être entretenue, n'ouvrez jamais l'enceinte de l'équipement ni ne remplacez aucun composant interne sans autorisation. Sinon, les pertes occasionnées ne sont pas couvertes par la garantie. Pour éviter le risque de choc électrique, ne réalisez aucune autre opération de maintenance en dehors de celles décrites dans ce manuel. Si nécessaire, contactez Fox ESS. Sinon, les pertes occasionnées ne sont pas couvertes par la garantie.

**1.3.6 Disposal Safety**

Please scrap the product in accordance with relevant local regulations and standards to avoid property losses or casualties.

**1.4 PE Connection and Leakage Current****PV System Residual Current Factors**

- In every PV installation, several elements contribute to the current leakage to protective earth (PE). These elements can be divided into two main types.

- Capacitive discharge current-Discharge current is generated mainly by the parasitic capacitance of the PV modules to PE. The module type, the environmental conditions (rain, humidity) and even the distance of the modules from the roof can effect the discharge current. Other factors that may contribute to the parasitic capacitance are the Fox PowerQ's internal capacitance to PE and external protection elements such as lighting protection.
- During operation, the DC bus is connected to the alternating current grid via the Fox PowerQ. Thus, a portion of the alternating voltage amplitude arrives at the DC bus. The fluctuating voltage constantly changes the charge state of the parasitic PV capacitor (i.e. capacitance to PE). This is associated with a displacement current, which is proportional to the capacitance and the applied voltage amplitude.
- Residual current-if there is a fault, such as defective insulation, where an energized cable comes into contact with a grounded person, an additional current flows, known as a residual current.

**Residual Current Device (RCD)**

- The Fox PowerQ incorporates a certified internal RCD (Residual Current Device) to protect against possible electrocution in case of a malfunction of the PV array, cables or Fox PowerQ (DC). The RCD in the Fox PowerQ can detect leakage on the DC side. There are 2 trip thresholds for the RCD as required by the UL1741 standard. A low threshold is used to protect against rapid changes in leakage typical of direct contact by people. A higher threshold is used for slowly rising leakage currents, to limit the current in grounding conductors for the safety. The default value for higher speed personal protection is 30 mA, and 30 mA, 60 mA, 150 mA per unit for lower speed fire safety.

## 2 System Overview

The Fox PowerQ energy storage system is a whole home energy solution for residential users. The three key components are Fox PowerQ which can convert solar energy to AC energy and store energy into battery, and FOX Hub G2 which is an energy management unit for whole-home power control. Users can monitor and operate their storage system remotely via the FoxCloud US mobile phone app.

- **System Advantages:**

- Easy installation: flexible configuration, plug and play set-up.
- High Voltage: compatible with high-voltage batteries for maximum round-trip efficiency.
- Type 4X: engineered to last with maximum flexibility, and suitable for outdoor installation.
- Remote monitoring: monitor your system remotely via smartphone app or web portal.
- 100% imbalance for Split-Phase Loads.
- High backup power, up to 12.5 kW.
- High scalability, up to 4 Fox PowerQ units in parallel.
- Fast battery charging, up to 50 A charging and 60 A discharging current.
- RSD transmitter inside: a Tigo or APsystem transmitter is integrated in the Fox PowerQ, and only RSD receivers should be installed by the installer.
- UPS switchover time: the switchover time from on-grid to off-grid or from off-grid to on-grid is less than 20ms.
- Generator ready: the FOX Hub G2 is ready to connect to an up to 200 A generator.
- Smart loads: 240 V or 120 V loads can be connected to the FOX Hub G2 and controlled according to the time and SOC.
- Safety & Reliability: transformerless design with software and hardware protection.
- Arc detection function: capability of detecting up to 35 A arc current. When the PV panel produces arc, the PCS will shut down immediately, disconnect the grid-side relay, turn off the BDC relay, and send instructions to turn off the battery. Meanwhile, turn off the quick shut-off device (RSD) to avoid the fire of the PV panel. After the arcing occurs, the Fox PowerQ will report the arcing fault immediately and upload it to the cloud.

### 2.1 Specifications

#### 2.1.1 Fox PowerQ Specification



The Fox PowerQ is a comprehensive device that combines both the cube inverter and the AIO EQ series batteries in a single unit.

The cube inverter manages the conversion of electrical energy between AC and DC forms. It handles the flow of power between the battery and the grid, ensuring efficient transfer and utilization of energy.

The AIO EQ series batteries, which stack up to 7 modules in US, are capable of storing excess energy generated during times of low demand and supplying it during times of high demand. The battery storage system is flexible for both whole home and partial home backup.





**The appearance of the Fox PowerQ is shown to the left.**

The Fox PowerQ comprises the following system models:

**US1H/US1AC-X-EQLY**

Wherein **X** represents the inverter power, and **Y** represents battery capacity.

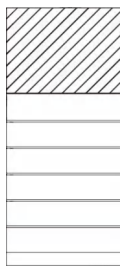
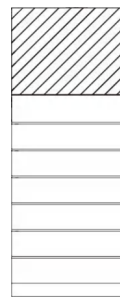



**X** is selected from 3.8, 5.7, 7.6, 9.6, or 11.4, and **Y** is selected from 2, 3, 4, 5, 6, or 7.

<b>CUBE HYBRID INVERTER + BATTERIES</b>						
<b>Cube System</b>						
						
System module	US1H-3.8-EQL 2	US1H-3.8-EQL 3	US1H-3.8-EQL 4	US1H-3.8-EQL 5	US1H-3.8-EQL 6	US1H-3.8-EQL 7
<b>Energy Storage</b>						
Total energy (KWh)	7.94	11.91	15.88	19.85	23.82	27.79
<b>AC Output</b>						
Max. continuous power (kW)	3.8	3.8	3.8	3.8	3.8	3.8
Max. output power without PV (kW)	3.8	3.8	3.8	3.8	3.8	3.8
Max. continuous current (A)	15.8	15.8	15.8	15.8	15.8	15.8
Nominal frequency (Hz)	60	60	60	60	60	60
Load start capacity (A) LRA	48	72	96	110	110	110
Imbalance for split-phase loads	100%	100%	100%	100%	100%	100%
<b>PV Input</b>						
Max. solar STC power (kW)	7.6	7.6	7.6	7.6	7.6	7.6
Max. PV input voltage (V)	600	600	600	600	600	600
MPPT voltage	80-550	80-550	80-550	80-550	80-550	80-550

range (V)						
Max.PV input current per MPPT(A)	28/14	28/14	28/14	28/14	28/14	28/14
MPPT & Strings	2 (MPPT 1: 2 Strings; MPPT 2: 1 String)	2 (MPPT 1: 2 Strings; MPPT 2: 1 String)	2 (MPPT 1: 2 Strings; MPPT 2: 1 String)	2 (MPPT 1: 2 Strings; MPPT 2: 1 String)	2 (MPPT 1: 2 Strings; MPPT 2: 1 String)	2 (MPPT 1: 2 Strings; MPPT 2: 1 String)
CEC efficiency (PV)	96.0%	96.0%	96.0%	96.0%	96.0%	96.0%
<b>General Data</b>						
Hybrid inverter Qty	1	1	1	1	1	1
Battery modules Qty	2	3	4	5	6	7
Base Qty	1	1	1	1	1	1
Dimension (W*H*D)	22.4inch*33.4inch (570mm*848mm*380mm)	22.4inch*38.8inch (570mm*986mm*380mm)	22.4inch*44.3inch (570mm*1124mm*380mm)	22.4inch*49.7inch (570mm*1262mm*380mm)	22.4inch*55.1inch (570mm*1400mm*380mm)	22.4inch*60.6inch (570mm*1538mm*380mm)
Weight	Inverter: 112.44lb (51kg); Battery module: 81.35lb (36.9kg); Base: 7.72lb (3.5kg); Total: 282.9lb (128.3kg)	Inverter: 112.44lb (51kg); Battery module: 81.35lb (36.9kg); Base: 7.72lb (3.5kg); Total: 364.2lb (165.2kg)	Inverter: 112.44lb (51kg); Battery module: 81.35lb (36.9kg); Base: 7.72lb (3.5kg); Total: 445.6lb (202.1kg)	Inverter: 112.44lb (51kg); Battery module: 81.35lb (36.9kg); Base: 7.72lb (3.5kg); Total: 526.9lb (239kg)	Inverter: 112.44lb (51kg); Battery module: 81.35lb (36.9kg); Base: 7.72lb (3.5kg); Total: 608.3lb (275.9kg)	Inverter: 112.44lb (51kg); Battery module: 81.35lb (36.9kg); Base: 7.72lb (3.5kg); Total: 689.6lb (312.8kg)
Enclosure rating	Type 4X	Type 4X	Type 4X	Type 4X	Type 4X	Type 4X
Operation temperature range	14°F~+131°F (-10°C~+55°C) derating above 104°F (40°C)	14°F~+131°F (-10°C~+55°C) derating above 104°F (40°C)	14°F~+131°F (-10°C~+55°C) derating above 104°F (40°C)	14°F~+131°F (-10°C~+55°C) derating above 104°F (40°C)	14°F~+131°F (-10°C~+55°C) derating above 104°F (40°C)	14°F~+131°F (-10°C~+55°C) derating above 104°F (40°C)
Relative humidity	0-100% (No Condensation)	0-100% (No Condensation)	0-100% (No Condensation)	0-100% (No Condensation)	0-100% (No Condensation)	0-100% (No Condensation)
Typical noise emission	<35dB	<35dB	<35dB	<35dB	<35dB	<35dB
Max. operation altitude	6, 560 ft (2000 m)	6, 560 ft (2000 m)	6, 560 ft (2000 m)	6, 560 ft (2000 m)	6, 560 ft (2000 m)	6, 560 ft (2000 m)
Internal consumption at	<25W	<25W	<25W	<25W	<25W	<25W

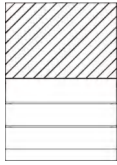
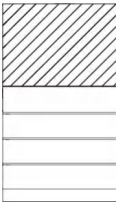

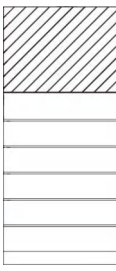
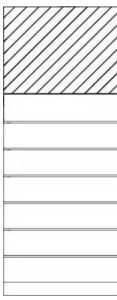



night						
Cooling method	Natural convection	Natural convection	Natural convection	Natural convection	Natural convection	Natural convection
Scalability	4	4	4	4	4	4
Safety and EMC	UL9540A, UL9540, UL1973, UL1741 SA, UL1741 SB, UL1741 CRD, CSA C22.2 No.107.1-16, UL1998, UL1699B, HECO SRD-V2.0; IEEE1547-2018, IEEE1547a-2020, IEEE1547.1-2020, Rule21; FCC part15 CLASS B	UL9540A, UL9540, UL1973, UL1741 SA, UL1741 SB, UL1741 CRD, CSA C22.2 No.107.1-16, UL1998, UL1699B, HECO SRD-V2.0; IEEE1547-2018, IEEE1547a-2020, IEEE1547.1-2020, Rule21; FCC part15 CLASS B	UL9540A, UL9540, UL1973, UL1741 SA, UL1741 SB, UL1741 CRD, CSA C22.2 No.107.1-16, UL1998, UL1699B, HECO SRD-V2.0; IEEE1547-2018, IEEE1547a-2020, IEEE1547.1-2020, Rule21; FCC part15 CLASS B	UL9540A, UL9540, UL1973, UL1741 SA, UL1741 SB, UL1741 CRD, CSA C22.2 No.107.1-16, UL1998, UL1699B, HECO SRD-V2.0; IEEE1547-2018, IEEE1547a-2020, IEEE1547.1-2020, Rule21; FCC part15 CLASS B	UL9540A, UL9540, UL1973, UL1741 SA, UL1741 SB, UL1741 CRD, CSA C22.2 No.107.1-16, UL1998, UL1699B, HECO SRD-V2.0; IEEE1547-2018, IEEE1547a-2020, IEEE1547.1-2020, Rule21; FCC part15 CLASS B	UL9540A, UL9540, UL1973, UL1741 SA, UL1741 SB, UL1741 CRD, CSA C22.2 No.107.1-16, UL1998, UL1699B, HECO SRD-V2.0; IEEE1547-2018, IEEE1547a-2020, IEEE1547.1-2020, Rule21; FCC part15 CLASS B
Mounting	Ground mounting	Ground mounting	Ground mounting	Ground mounting	Ground mounting	Ground mounting
Display	LED, App, Website	LED, App, Website	LED, App, Website	LED, App, Website	LED, App, Website	LED, App, Website
Communication	WiFi, 4G, LAN	WiFi, 4G, LAN	WiFi, 4G, LAN	WiFi, 4G, LAN	WiFi, 4G, LAN	WiFi, 4G, LAN
Interface	CAN2.0, RS485, Meter, CT, ISO alarm, SUNSPEC	CAN2.0, RS485, Meter, CT, ISO alarm, SUNSPEC	CAN2.0, RS485, Meter, CT, ISO alarm, SUNSPEC	CAN2.0, RS485, Meter, CT, ISO alarm, SUNSPEC	CAN2.0, RS485, Meter, CT, ISO alarm, SUNSPEC	CAN2.0, RS485, Meter, CT, ISO alarm, SUNSPEC
Warranty	12.5 years	12.5 years	12.5 years	12.5 years	12.5 years	12.5 years

<b>CUBE HYBRID INVERTER + BATTERIES</b>						
<b>Cube System</b>						
						
System module	US1H-5.7-EQL 2	US1H-5.7-EQL 3	US1H-5.7-EQL 4	US1H-5.7-EQL 5	US1H-5.7-EQL 6	US1H-5.7-EQL 7
Total energy (KWh)	7.94	11.91	15.88	19.85	23.82	27.79
<b>AC Output</b>						
Max. continuous power (kW)	5.7	5.7	5.7	5.7	5.7	5.7
Max. output power without PV (kW)	5.7	5.7	5.7	5.7	5.7	5.7
Max. continuous current (A)	23.8	23.8	23.8	23.8	23.8	23.8
Nominal frequency (Hz)	60	60	60	60	60	60
Load start capacity (A) LRA	48	72	96	110	110	110
Imbalance for split-phase loads	100%	100%	100%	100%	100%	100%
<b>PV Input</b>						
Max. solar STC power (kW)	11.4	11.4	11.4	11.4	11.4	11.4
Max. PV input voltage (V)	600	600	600	600	600	600
MPPT voltage range (V)	80-550	80-550	80-550	80-550	80-550	80-550
Max. PV input current per MPPT(A)	28/14	28/14	28/14	28/14	28/14	28/14
MPPT & Strings	2 (MPPT 1: 2	2 (MPPT 1: 2	2 (MPPT 1: 2	2 (MPPT 1: 2	2 (MPPT 1: 2	2 (MPPT 1: 2

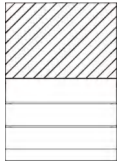
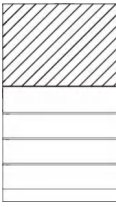
	Strings; MPPT 2: 1 String)	Strings; MPPT 2: 1 String)	Strings; MPPT 2: 1 String)	Strings; MPPT 2: 1 String)	Strings; MPPT 2: 1 String)	Strings; MPPT 2: 1 String)
CEC efficiency (PV)	97.0%	97.0%	97.0%	97.0%	97.0%	97.0%
<b>General Data</b>						
Hybrid inverter Qty	1	1	1	1	1	1
Battery modules Qty	2	3	4	5	6	7
Base Qty	1	1	1	1	1	1
Dimension (W*H*D)	22.4inch*33.4inch ch*15inch (570mm*848mm*380mm)	22.4inch*38.8inch ch*15inch (570mm*986mm*380mm)	22.4inch*44.3inch ch*15inch (570mm*1124mm*380mm)	22.4inch*49.7inch ch*15inch (570mm*1262mm*380mm)	22.4inch*55.1inch ch*15inch (570mm*1400mm*380mm)	22.4inch*60.6inch ch*15inch (570mm*1538mm*380mm)
Weight	Inverter: 112.44lb (51kg); Battery module: 81.35lb (36.9kg); Base: 7.72lb (3.5kg); Total: 282.9lb (128.3kg)	Inverter: 112.44lb (51kg); Battery module: 81.35lb (36.9kg); Base: 7.72lb (3.5kg); Total: 364.2lb (165.2kg)	Inverter: 112.44lb (51kg); Battery module: 81.35lb (36.9kg); Base: 7.72lb (3.5kg); Total: 445.6lb (202.1kg)	Inverter: 112.44lb (51kg); Battery module: 81.35lb (36.9kg); Base: 7.72lb (3.5kg); Total: 526.9lb (239kg)	Inverter: 112.44lb (51kg); Battery module: 81.35lb (36.9kg); Base: 7.72lb (3.5kg); Total: 608.3lb (275.9kg)	Inverter: 112.44lb (51kg); Battery module: 81.35lb (36.9kg); Base: 7.72lb (3.5kg); Total: 689.6lb (312.8kg)
Enclosure rating	Type 4X	Type 4X	Type 4X	Type 4X	Type 4X	Type 4X
Operation temperature range	14°F~+131°F (-10 °C~ +55 °C) derating above 104°F(40°C)	14°F~+131°F (-10 °C ~ +55 °C) derating above 104°F(40°C)	14°F~+131°F (-10 °C ~ +55 °C) derating above 104°F(40°C)	14°F~+131°F (-10 °C ~ +55 °C) derating above 104°F(40°C)	14°F~+131°F (-10 °C ~ +55 °C) derating above 104°F(40°C)	14°F~+131°F (-10 °C ~ +55 °C) derating above 104°F(40°C)
Relative humidity	0-100% (No Condensation)	0-100% (No Condensation)	0-100% (No Condensation)	0-100% (No Condensation)	0-100% (No Condensation)	0-100% (No Condensation)
Typical noise emission	<35dB	<35dB	<35dB	<35dB	<35dB	<35dB
Max. operation altitude	6, 560 ft (2000 m)	6, 560 ft (2000 m)	6, 560 ft (2000 m)	6, 560 ft (2000 m)	6, 560 ft (2000 m)	6, 560 ft (2000 m)
Internal consumption at night	<25W	<25W	<25W	<25W	<25W	<25W
Cooling Method	Natural convection	Natural convection	Natural convection	Natural convection	Natural convection	Natural convection
Scalability	4	4	4	4	4	4

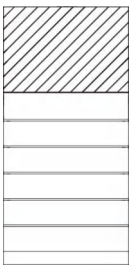
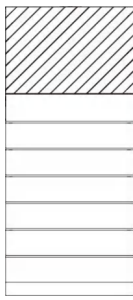
Safety and EMC	UL9540A, UL9540, UL1973, UL1741 SA, UL 1741 SB, UL1741 CRD, CSA C22.2 No.107.1-16, UL1998, UL1699B, HECO SRD-V2.0; IEEE1547-201 8, IEEE1547a-20 20, IEEE1547.1-20 20, Rule21; FCC part15 CLASS B	UL9540A, UL9540, UL1973, UL1741 SA, UL 1741 SB, UL1741 CRD, CSA C22.2 No.107.1-16, UL1998, UL1699B, HECO SRD-V2.0; IEEE1547-201 8, IEEE1547a-20 20, IEEE1547.1-20 20, Rule21; FCC part15 CLASS B	UL9540A, UL9540, UL1973, UL1741 SA, UL 1741 SB, UL1741 CRD, CSA C22.2 No.107.1-16, UL1998, UL1699B, HECO SRD-V2.0; IEEE1547-201 8, IEEE1547a-20 20, IEEE1547.1-20 20, Rule21; FCC part15 CLASS B	UL9540A, UL9540, UL1973, UL1741 SA, UL 1741 SB, UL1741 CRD, CSA C22.2 No.107.1-16, UL1998, UL1699B, HECO SRD-V2.0; IEEE1547-201 8, IEEE1547a-20 20, IEEE1547.1-20 20, Rule21; FCC part15 CLASS B	UL9540A, UL9540, UL1973, UL1741 SA, UL 1741 SB, UL1741 CRD, CSA C22.2 No.107.1-16, UL1998, UL1699B, HECO SRD-V2.0; IEEE1547-201 8, IEEE1547a-20 20, IEEE1547.1-20 20, Rule21; FCC part15 CLASS B	UL9540A, UL9540, UL1973, UL1741 SA, UL 1741 SB, UL1741 CRD, CSA C22.2 No.107.1-16, UL1998, UL1699B, HECO SRD-V2.0; IEEE1547-201 8, IEEE1547a-20 20, IEEE1547.1-20 20, Rule21; FCC part15 CLASS B
Mounting	Ground mounting	Ground mounting	Ground mounting	Ground mounting	Ground mounting	Ground mounting
Display	LED, App, Website	LED, App, Website	LED, App, Website	LED, App, Website	LED, App, Website	LED, App, Website
Communication	WiFi, 4G, LAN	WiFi, 4G, LAN	WiFi, 4G, LAN	WiFi, 4G, LAN	WiFi, 4G, LAN	WiFi, 4G, LAN
Interface	CAN2.0, RS485, Meter, CT, ISO alarm, SUNSPEC	CAN2.0, RS485, Meter, CT, ISO alarm, SUNSPEC	CAN2.0, RS485, Meter, CT, ISO alarm, SUNSPEC	CAN2.0, RS485, Meter, CT, ISO alarm, SUNSPEC	CAN2.0, RS485, Meter, CT, ISO alarm, SUNSPEC	CAN2.0, RS485, Meter, CT, ISO alarm, SUNSPEC
Warranty	12.5 years	12.5 years	12.5 years	12.5 years	12.5 years	12.5 years

<b>CUBE HYBRID INVERTER + BATTERIES</b>						
<b>Cube System</b>						
						
System module	US1H-7.6-EQL 2	US1H-7.6-EQL 3	US1H-7.6-EQL 4	US1H-7.6-EQL 5	US1H-7.6-EQL 6	US1H-7.6-EQL 7
<b>Energy Storage</b>						
Total energy (KWh)	7.94	11.91	15.88	19.85	23.82	27.79
<b>AC Output</b>						
Max. continuous power (kW)	7.6	7.6	7.6	7.6	7.6	7.6
Max. output power without PV (kW)	5.76	7.6	7.6	7.6	7.6	7.6
Max. continuous current (A)	31.7	31.7	31.7	31.7	31.7	31.7
Nominal frequency (Hz)	60	60	60	60	60	60
Load start capacity (A) LRA	48	72	96	110	110	110
Imbalance for split-phase loads	100%	100%	100%	100%	100%	100%
<b>PV Input</b>						
Max. solar STC power (kW)	15.2	15.2	15.2	15.2	15.2	15.2
Max. PV input voltage (V)	600	600	600	600	600	600
MPPT voltage range (V)	80-550	80-550	80-550	80-550	80-550	80-550
Max. PV input current per MPPT(A)	28/14	28/14	28/14	28/14	28/14	28/14
MPPT & Strings	2 (MPPT 1: 2 Strings; MPPT 2: 1 String)	2 (MPPT 1: 2 Strings; MPPT 2: 1 String)	2 (MPPT 1: 2 Strings; MPPT 2: 1 String)	2 (MPPT 1: 2 Strings; MPPT 2: 1 String)	2 (MPPT 1: 2 Strings; MPPT 2: 1 String)	2 (MPPT 1: 2 Strings; MPPT 2: 1 String)

CEC efficiency (PV)	97.0%	97.0%	97.0%	97.0%	97.0%	97.0%
<b>General Data</b>						
Hybrid inverter Qty	1	1	1	1	1	1
Battery modules Qty	2	3	4	5	6	7
Base Qty	1	1	1	1	1	1
Dimension (W*H*D)	22.4inch*33.4inch*15inch (570mm*848mm*380mm)	22.4inch*38.8inch*15inch (570mm*986mm*380mm)	22.4inch*44.3inch*15inch (570mm*1124mm*380mm)	22.4inch*49.7inch*15inch (570mm*1262mm*380mm)	22.4inch*55.1inch*15inch (570mm*1400mm*380mm)	22.4inch*60.6inch*15inch (570mm*1538mm*380mm)
Weight	Inverter: 112.44lb (51kg); Battery module: 81.35lb (36.9kg); Base: 7.72lb (3.5kg); Total: 282.9lb (128.3kg)	Inverter: 112.44lb (51kg); Battery module: 81.35lb (36.9kg); Base: 7.72lb (3.5kg); Total: 364.2lb (165.2kg)	Inverter: 112.44lb (51kg); Battery module: 81.35lb (36.9kg); Base: 7.72lb (3.5kg); Total: 445.6lb (202.1kg)	Inverter: 112.44lb (51kg); Battery module: 81.35lb (36.9kg); Base: 7.72lb (3.5kg); Total: 526.9lb (239kg)	Inverter: 112.44lb (51kg); Battery module: 81.35lb (36.9kg); Base: 7.72lb (3.5kg); Total: 608.3lb (275.9kg)	Inverter: 112.44lb (51kg); Battery module: 81.35lb (36.9kg); Base: 7.72lb (3.5kg); Total: 689.6lb (312.8kg)
Enclosure rating	Type 4X	Type 4X	Type 4X	Type 4X	Type 4X	Type 4X
Operation temperature range	14°F~+131°F (-10 °C ~ +55 °C) derating above 104°F(40°C)	14°F~+131°F (-10 °C ~ +55 °C) derating above 104°F(40°C)	14°F~+131°F (-10 °C ~ +55 °C) derating above 104°F(40°C)	14°F~+131°F (-10 °C ~ +55 °C) derating above 104°F(40°C)	14°F~+131°F (-10 °C ~ +55 °C) derating above 104°F(40°C)	14°F~+131°F (-10 °C ~ +55 °C) derating above 104°F(40°C)
Relative humidity	0-100% (No Condensation)	0-100% (No Condensation)	0-100% (No Condensation)	0-100% (No Condensation)	0-100% (No Condensation)	0-100% (No Condensation)
Typical noise emission	<35dB	<35dB	<35dB	<35dB	<35dB	<35dB
Max. operation altitude	6, 560 ft (2000 m)	6, 560 ft (2000 m)	6, 560 ft (2000 m)	6, 560 ft (2000 m)	6, 560 ft (2000 m)	6, 560 ft (2000 m)
Internal consumption at night	<25W	<25W	<25W	<25W	<25W	<25W
Cooling Method	Natural convection	Natural convection	Natural convection	Natural convection	Natural convection	Natural convection
Scalability	4	4	4	4	4	4



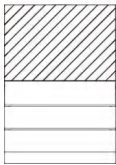
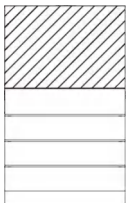
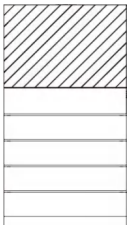
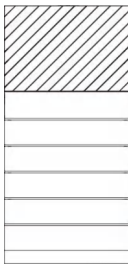
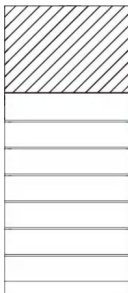
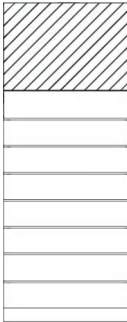

Safety and EMC	UL9540A, UL9540, UL1973, UL1741 SA, UL 1741 SB, UL1741 CRD, CSA C22.2 No.107.1-16, UL1998, UL1699B, HECO SRD-V2.0; IEEE1547-201 8, IEEE1547a-20 20, IEEE1547.1-20 20, Rule21; FCC part15 CLASS B	UL9540A, UL9540, UL1973, UL1741 SA, UL 1741 SB, UL1741 CRD, CSA C22.2 No.107.1-16, UL1998, UL1699B, HECO SRD-V2.0; IEEE1547-201 8, IEEE1547a-20 20, IEEE1547.1-20 20, Rule21; FCC part15 CLASS B	UL9540A, UL9540, UL1973, UL1741 SA, UL 1741 SB, UL1741 CRD, CSA C22.2 No.107.1-16, UL1998, UL1699B, HECO SRD-V2.0; IEEE1547-201 8, IEEE1547a-20 20, IEEE1547.1-20 20, Rule21; FCC part15 CLASS B	UL9540A, UL9540, UL1973, UL1741 SA, UL 1741 SB, UL1741 CRD, CSA C22.2 No.107.1-16, UL1998, UL1699B, HECO SRD-V2.0; IEEE1547-201 8, IEEE1547a-20 20, IEEE1547.1-20 20, Rule21; FCC part15 CLASS B	UL9540A, UL9540, UL1973, UL1741 SA, UL 1741 SB, UL1741 CRD, CSA C22.2 No.107.1-16, UL1998, UL1699B, HECO SRD-V2.0; IEEE1547-201 8, IEEE1547a-20 20, IEEE1547.1-20 20, Rule21; FCC part15 CLASS B	UL9540A, UL9540, UL1973, UL1741 SA, UL 1741 SB, UL1741 CRD, CSA C22.2 No.107.1-16, UL1998, UL1699B, HECO SRD-V2.0; IEEE1547-201 8, IEEE1547a-20 20, IEEE1547.1-20 20, Rule21; FCC part15 CLASS B
Mounting	Ground mounting	Ground mounting	Ground mounting	Ground mounting	Ground mounting	Ground mounting
Display	LED, App, Website	LED, App, Website	LED, App, Website	LED, App, Website	LED, App, Website	LED, App, Website
Communication	WiFi, 4G, LAN	WiFi, 4G, LAN	WiFi, 4G, LAN	WiFi, 4G, LAN	WiFi, 4G, LAN	WiFi, 4G, LAN
Interface	CAN2.0, RS485, Meter, CT, ISO alarm, SUNSPEC	CAN2.0, RS485, Meter, CT, ISO alarm, SUNSPEC	CAN2.0, RS485, Meter, CT, ISO alarm, SUNSPEC	CAN2.0, RS485, Meter, CT, ISO alarm, SUNSPEC	CAN2.0, RS485, Meter, CT, ISO alarm, SUNSPEC	CAN2.0, RS485, Meter, CT, ISO alarm, SUNSPEC
Warranty	12.5 years	12.5 years	12.5 years	12.5 years	12.5 years	12.5 years

<b>CUBE HYBRID INVERTER + BATTERIES</b>						
<b>Cube System</b>						
						
System module	US1H-9.6-EQL 2	US1H-9.6-EQL 3	US1H-9.6-EQL 4	US1H-7.6-EQL 5	US1H-9.6-EQL 6	US1H-9.6-EQL 7
<b>Energy Storage</b>						
Total energy (KWh)	7.94	11.91	15.88	19.85	23.82	27.79
<b>AC Output</b>						
Max. continuous power (kW)	9.6	9.6	9.6	9.6	9.6	9.6
Max. output power without PV (kW)	5.76	8.64	9.6	9.6	9.6	9.6
Max. continuous current (A)	40	40	40	40	40	40
Nominal frequency (Hz)	60	60	60	60	60	60
Load start capacity (A) LRA	48	72	96	110	110	110
Imbalance for split-phase loads	100%	100%	100%	100%	100%	100%
<b>PV Input</b>						
Max. solar STC power (kW)	19.2	19.2	19.2	19.2	19.2	19.2
Max. PV input voltage (V)	600	600	600	600	600	600
MPPT voltage range (V)	80-550	80-550	80-550	80-550	80-550	80-550
Max. PV input current per MPPT(A)	28/14/14	28/14/14	28/14/14	28/14/14	28/14/14	28/14/14
MPPT & Strings	3 (MPPT 1: 2 Strings; MPPT 2&3: 1 String)	3 (MPPT 1: 2 Strings; MPPT 2&3: 1 String)	3 (MPPT 1: 2 Strings; MPPT 2&3: 1 String)	3 (MPPT 1: 2 Strings; MPPT 2&3: 1 String)	3 (MPPT 1: 2 Strings; MPPT 2&3: 1 String)	3 (MPPT 1: 2 Strings; MPPT 2&3: 1 String)



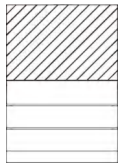
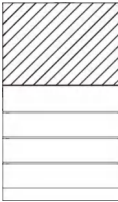

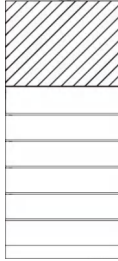
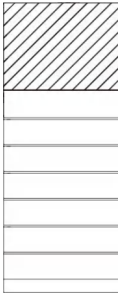
CEC efficiency (PV)	97.0%	97.0%	97.0%	97.0%	97.0%	97.0%
<b>General Data</b>						
Hybrid inverter Qty	1	1	1	1	1	1
Battery modules Qty	2	3	4	5	6	7
Base Qty	1	1	1	1	1	1
Dimension (W*H*D)	22.4inch*33.4inch*15inch (570mm*848mm*380mm)	22.4inch*38.8inch*15inch (570mm*986mm*380mm)	22.4inch*44.3inch*15inch (570mm*1124mm*380mm)	22.4inch*49.7inch*15inch (570mm*1262mm*380mm)	22.4inch*55.1inch*15inch (570mm*1400mm*380mm)	22.4inch*60.6inch*15inch (570mm*1538mm*380mm)
Weight	Inverter: 112.44lb (51kg); Battery module: 81.35lb (36.9kg); Base: 7.72lb (3.5kg); Total: 282.9lb (128.3kg)	Inverter: 112.44lb (51kg); Battery module: 81.35lb (36.9kg); Base: 7.72lb (3.5kg); Total: 364.2lb (165.2kg)	Inverter: 112.44lb (51kg); Battery module: 81.35lb (36.9kg); Base: 7.72lb (3.5kg); Total: 445.6lb (202.1kg)	Inverter: 112.44lb (51kg); Battery module: 81.35lb (36.9kg); Base: 7.72lb (3.5kg); Total: 526.9lb (239kg)	Inverter: 112.44lb (51kg); Battery module: 81.35lb (36.9kg); Base: 7.72lb (3.5kg); Total: 608.3lb (275.9kg)	Inverter: 112.44lb (51kg); Battery module: 81.35lb (36.9kg); Base: 7.72lb (3.5kg); Total: 689.6lb (312.8kg)
Enclosure rating	Type 4X	Type 4X	Type 4X	Type 4X	Type 4X	Type 4X
Operation temperature range	14°F~+131°F (-10 °C ~ +55 °C) derating above 104°F(40°C)	14°F~+131°F (-10 °C ~ +55 °C) derating above 104°F(40°C)	14°F~+131°F (-10 °C ~ +55 °C) derating above 104°F(40°C)	14°F~+131°F (-10 °C ~ +55 °C) derating above 104°F(40°C)	14°F~+131°F (-10 °C ~ +55 °C) derating above 104°F(40°C)	14°F~+131°F (-10 °C ~ +55 °C) derating above 104°F(40°C)
Relative humidity	0-100% (No Condensation)	0-100% (No Condensation)	0-100% (No Condensation)	0-100% (No Condensation)	0-100% (No Condensation)	0-100% (No Condensation)
Typical noise emission	<35dB	<35dB	<35dB	<35dB	<35dB	<35dB
Max. operation altitude	6, 560 ft (2000 m)	6, 560 ft (2000 m)	6, 560 ft (2000 m)	6, 560 ft (2000 m)	6, 560 ft (2000 m)	6, 560 ft (2000 m)
Internal consumption at night	<25W	<25W	<25W	<25W	<25W	<25W
Cooling method	Natural convection	Natural convection	Natural convection	Natural convection	Natural convection	Natural convection
Scalability	4	4	4	4	4	4

Safety and EMC	UL9540A, UL9540, UL1973, UL1741 SA, UL 1741 SB, UL1741 CRD, CSA C22.2 No.107.1-16, UL1998, UL1699B, HECO SRD-V2.0; IEEE1547-201 8, IEEE1547a-20 20, IEEE1547.1-20 20, Rule21; FCC part15 CLASS B	UL9540A, UL9540, UL1973, UL1741 SA, UL 1741 SB, UL1741 CRD, CSA C22.2 No.107.1-16, UL1998, UL1699B, HECO SRD-V2.0; IEEE1547-201 8, IEEE1547a-20 20, IEEE1547.1-20 20, Rule21; FCC part15 CLASS B	UL9540A, UL9540, UL1973, UL1741 SA, UL 1741 SB, UL1741 CRD, CSA C22.2 No.107.1-16, UL1998, UL1699B, HECO SRD-V2.0; IEEE1547-201 8, IEEE1547a-20 20, IEEE1547.1-20 20, Rule21; FCC part15 CLASS B	UL9540A, UL9540, UL1973, UL1741 SA, UL 1741 SB, UL1741 CRD, CSA C22.2 No.107.1-16, UL1998, UL1699B, HECO SRD-V2.0; IEEE1547-201 8, IEEE1547a-20 20, IEEE1547.1-20 20, Rule21; FCC part15 CLASS B	UL9540A, UL9540, UL1973, UL1741 SA, UL 1741 SB, UL1741 CRD, CSA C22.2 No.107.1-16, UL1998, UL1699B, HECO SRD-V2.0; IEEE1547-201 8, IEEE1547a-20 20, IEEE1547.1-20 20, Rule21; FCC part15 CLASS B	UL9540A, UL9540, UL1973, UL1741 SA, UL 1741 SB, UL1741 CRD, CSA C22.2 No.107.1-16, UL1998, UL1699B, HECO SRD-V2.0; IEEE1547-201 8, IEEE1547a-20 20, IEEE1547.1-20 20, Rule21; FCC part15 CLASS B
Mounting	Ground mounting	Ground mounting	Ground mounting	Ground mounting	Ground mounting	Ground mounting
Display	LED, App, Website	LED, App, Website	LED, App, Website	LED, App, Website	LED, App, Website	LED, App, Website
Communication	WiFi, 4G, LAN	WiFi, 4G, LAN	WiFi, 4G, LAN	WiFi, 4G, LAN	WiFi, 4G, LAN	WiFi, 4G, LAN
Interface	CAN2.0, RS485, Meter, CT, ISO alarm, SUNSPEC	CAN2.0, RS485, Meter, CT, ISO alarm, SUNSPEC	CAN2.0, RS485, Meter, CT, ISO alarm, SUNSPEC	CAN2.0, RS485, Meter, CT, ISO alarm, SUNSPEC	CAN2.0, RS485, Meter, CT, ISO alarm, SUNSPEC	CAN2.0, RS485, Meter, CT, ISO alarm, SUNSPEC
Warranty	12.5 years	12.5 years	12.5 years	12.5 years	12.5 years	12.5 years

<b>CUBE HYBRID INVERTER + BATTERIES</b>						
<b>Cube System</b>						
						
System module	US1H-11.4-EQ L2	US1H-11.4-EQ L3	US1H-11.4-EQ L4	US1H-11.4-EQ L5	US1H-11.4-EQ L6	US1H-11.4-EQ L7
<b>Energy Storage</b>						
Total energy (KWh)	7.94	11.91	15.88	19.85	23.82	27.79
<b>AC Output</b>						
Max. continuous power (kW)	11.4	11.4	11.4	11.4	11.4	11.4
Max. output power without PV (kW)	5.76	8.64	11.4	11.4	11.4	11.4
Max. continuous current (A)	47.5	47.5	47.5	47.5	47.5	47.5
Nominal frequency (Hz)	60	60	60	60	60	60
Load start capacity (A) LRA	48	72	96	110	110	110
Imbalance for split-phase loads	100%	100%	100%	100%	100%	100%
<b>PV Input</b>						
Max. solar STC power (kW)	22.8	22.8	22.8	22.8	22.8	22.8
Max. PV input voltage (V)	600	600	600	600	600	600
MPPT voltage range (V)	80-550	80-550	80-550	80-550	80-550	80-550
Max. PV input current per MPPT(A)	28/14/14	28/14/14	28/14/14	28/14/14	28/14/14	28/14/14
MPPT & Strings	3 (MPPT 1: 2 Strings; MPPT 2&3: 1 String)	3 (MPPT 1: 2 Strings; MPPT 2&3: 1 String)	3 (MPPT 1: 2 Strings; MPPT 2&3: 1 String)	3 (MPPT 1: 2 Strings; MPPT 2&3: 1 String)	3 (MPPT 1: 2 Strings; MPPT 2&3: 1 String)	3 (MPPT 1: 2 Strings; MPPT 2&3: 1 String)

CEC efficiency (PV)	97.5%	97.5%	97.5%	97.5%	97.5%	97.5%
<b>General Data</b>						
Hybrid inverter Qty	1	1	1	1	1	1
Battery modules Qty	2	3	4	5	6	7
Base Qty	1	1	1	1	1	1
Dimension (W*H*D)	22.4inch*33.4inch*15inch (570mm*848mm*380mm)	22.4inch*38.8inch*15inch (570mm*986mm*380mm)	22.4inch*44.3inch*15inch (570mm*1124mm*380mm)	22.4inch*49.7inch*15inch (570mm*1262mm*380mm)	22.4inch*55.1inch*15inch (570mm*1400mm*380mm)	22.4inch*60.6inch*15inch (570mm*1538mm*380mm)
Weight	Inverter: 112.44lb (51kg); Battery module: 81.35lb (36.9kg); Base: 7.72lb (3.5kg); Total: 282.9lb (128.3kg)	Inverter: 112.44lb (51kg); Battery module: 81.35lb (36.9kg); Base: 7.72lb (3.5kg); Total: 364.2lb (165.2kg)	Inverter: 112.44lb (51kg); Battery module: 81.35lb (36.9kg); Base: 7.72lb (3.5kg); Total: 445.6lb (202.1kg)	Inverter: 112.44lb (51kg); Battery module: 81.35lb (36.9kg); Base: 7.72lb (3.5kg); Total: 526.9lb (239kg)	Inverter: 112.44lb (51kg); Battery module: 81.35lb (36.9kg); Base: 7.72lb (3.5kg); Total: 608.3lb (275.9kg)	Inverter: 112.44lb (51kg); Battery module: 81.35lb (36.9kg); Base: 7.72lb (3.5kg); Total: 689.6lb (312.8kg)
Enclosure rating	Type 4X	Type 4X	Type 4X	Type 4X	Type 4X	Type 4X
Operation temperature range	14°F~+131°F (-10 °C ~ +55 °C) derating above 104°F(40°C)	14°F~+131°F (-10 °C ~ +55 °C) derating above 104°F(40°C)	14°F~+131°F (-10 °C ~ +55 °C) derating above 104°F(40°C)	14°F~+131°F (-10 °C ~ +55 °C) derating above 104°F(40°C)	14°F~+131°F (-10 °C ~ +55 °C) derating above 104°F(40°C)	14°F~+131°F (-10 °C ~ +55 °C) derating above 104°F(40°C)
Relative humidity	0-100% (No Condensation)	0-100% (No Condensation)	0-100% (No Condensation)	0-100% (No Condensation)	0-100% (No Condensation)	0-100% (No Condensation)
Typical noise emission	<35dB	<35dB	<35dB	<35dB	<35dB	<35dB
Max. operation altitude	6, 560 ft (2000 m)	6, 560 ft (2000 m)	6, 560 ft (2000 m)	6, 560 ft (2000 m)	6, 560 ft (2000 m)	6, 560 ft (2000 m)
Internal consumption at night	<25W	<25W	<25W	<25W	<25W	<25W
Cooling method	Natural convection	Natural convection	Natural convection	Natural convection	Natural convection	Natural convection
Scalability	4	4	4	4	4	4

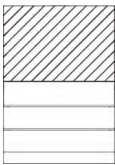
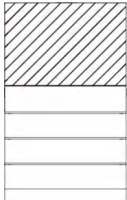
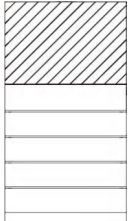
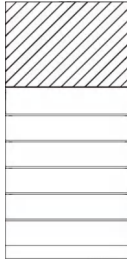
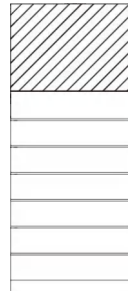

Safety and EMC	UL9540A, UL9540, UL1973, UL1741 SA, UL 1741 SB, UL1741 CRD, CSA C22.2 No.107.1-16, UL1998, UL1699B, HECO SRD-V2.0; IEEE1547-201 8, IEEE1547a-20 20, IEEE1547.1-20 20, Rule21; FCC part15 CLASS B	UL9540A, UL9540, UL1973, UL1741 SA, UL 1741 SB, UL1741 CRD, CSA C22.2 No.107.1-16, UL1998, UL1699B, HECO SRD-V2.0; IEEE1547-201 8, IEEE1547a-20 20, IEEE1547.1-20 20, Rule21; FCC part15 CLASS B	UL9540A, UL9540, UL1973, UL1741 SA, UL 1741 SB, UL1741 CRD, CSA C22.2 No.107.1-16, UL1998, UL1699B, HECO SRD-V2.0; IEEE1547-201 8, IEEE1547a-20 20, IEEE1547.1-20 20, Rule21; FCC part15 CLASS B	UL9540A, UL9540, UL1973, UL1741 SA, UL 1741 SB, UL1741 CRD, CSA C22.2 No.107.1-16, UL1998, UL1699B, HECO SRD-V2.0; IEEE1547-201 8, IEEE1547a-20 20, IEEE1547.1-20 20, Rule21; FCC part15 CLASS B	UL9540A, UL9540, UL1973, UL1741 SA, UL 1741 SB, UL1741 CRD, CSA C22.2 No.107.1-16, UL1998, UL1699B, HECO SRD-V2.0; IEEE1547-201 8, IEEE1547a-20 20, IEEE1547.1-20 20, Rule21; FCC part15 CLASS B	UL9540A, UL9540, UL1973, UL1741 SA, UL 1741 SB, UL1741 CRD, CSA C22.2 No.107.1-16, UL1998, UL1699B, HECO SRD-V2.0; IEEE1547-201 8, IEEE1547a-20 20, IEEE1547.1-20 20, Rule21; FCC part15 CLASS B
Mounting	Ground mounting	Ground mounting	Ground mounting	Ground mounting	Ground mounting	Ground mounting
Display	LED, App, Website	LED, App, Website	LED, App, Website	LED, App, Website	LED, App, Website	LED, App, Website
Communication	WiFi, 4G, LAN	WiFi, 4G, LAN	WiFi, 4G, LAN	WiFi, 4G, LAN	WiFi, 4G, LAN	WiFi, 4G, LAN
Interface	CAN2.0, RS485, Meter, CT, ISO alarm, SUNSPEC	CAN2.0, RS485, Meter, CT, ISO alarm, SUNSPEC	CAN2.0, RS485, Meter, CT, ISO alarm, SUNSPEC	CAN2.0, RS485, Meter, CT, ISO alarm, SUNSPEC	CAN2.0, RS485, Meter, CT, ISO alarm, SUNSPEC	CAN2.0, RS485, Meter, CT, ISO alarm, SUNSPEC
Warranty	12.5 years	12.5 years	12.5 years	12.5 years	12.5 years	12.5 years

<b>CUBE AC COUPLE INVERTER + BATTERIES</b>						
<b>Cube System</b>						
						
System module	US1AC-3.8-EQ L2	US1AC-3.8-EQ L3	US1AC-3.8-EQ L4	US1AC-3.8-EQ L5	US1AC-3.8-EQ L6	US1AC-3.8-EQ L7
<b>Energy storage</b>						
Total energy	7.94	11.91	15.88	19.85	23.82	27.79
<b>AC Output</b>						
Max. continuous power (kW)	3.8	3.8	3.8	3.8	3.8	3.8
Max. continuous current (A)	15.8	15.8	15.8	15.8	15.8	15.8
Nominal frequency (Hz)	60	60	60	60	60	60
Load start capacity (A) LRA	48	72	96	110	110	110
Imbalance for split-phase loads	100%	100%	100%	100%	100%	100%
CEC efficiency	95.5%	95.5%	95.5%	95.5%	95.5%	95.5%
<b>General Data</b>						
Hybrid inverter Qty	1	1	1	1	1	1
Battery modules Qty	2	3	4	5	6	7
Base Qty	1	1	1	1	1	1
Dimension (W*H*D)	22.4inch*33.4inch*15inch (570mm*848mm*380mm)	22.4inch*38.8inch*15inch (570mm*986mm*380mm)	22.4inch*44.3inch*15inch (570mm*1124mm*380mm)	22.4inch*49.7inch*15inch (570mm*1262mm*380mm)	22.4inch*55.1inch*15inch (570mm*1400mm*380mm)	22.4inch*60.6inch*15inch (570mm*1538mm*380mm)
Weight	Inverter: 112.44lb (51kg); Battery module: 81.35lb	Inverter: 112.44lb (51kg); Battery module: 81.35lb	Inverter: 112.44lb (51kg); Battery module: 81.35lb	Inverter: 112.44lb (51kg); Battery module: 81.35lb	Inverter: 112.44lb (51kg); Battery module: 81.35lb	Inverter: 112.44lb (51kg); Battery module: 81.35lb

	(36.9kg); Base: 7.72lb (3.5kg); Total: 282.9lb (128.3kg)	(36.9kg); Base: 7.72lb (3.5kg); Total: 364.2lb (165.2kg)	(36.9kg); Base: 7.72lb (3.5kg); Total: 445.6lb (202.1kg)	(36.9kg); Base: 7.72lb (3.5kg); Total: 526.9lb (239kg)	(36.9kg); Base: 7.72lb (3.5kg); Total: 608.3lb (275.9kg)	(36.9kg); Base: 7.72lb (3.5kg); Total: 689.6lb (312.8kg)
Enclosure rating	Type 4X	Type 4X	Type 4X	Type 4X	Type 4X	Type 4X
Operation temperature range	14°F~+131°F (-10 °C ~ +55 °C) derating above 104°F(40°C)	14°F~+131°F (-10 °C ~ +55 °C) derating above 104°F(40°C)	14°F~+131°F (-10 °C ~ +55 °C) derating above 104°F(40°C)	14°F~+131°F (-10 °C ~ +55 °C) derating above 104°F(40°C)	14°F~+131°F (-10 °C ~ +55 °C) derating above 104°F(40°C)	14°F~+131°F (-10 °C ~ +55 °C) derating above 104°F(40°C)
Relative humidity	0-100% (No Condensation )	0-100% (No Condensation )	0-100% (No Condensation )	0-100% (No Condensation )	0-100% (No Condensation )	0-100% (No Condensation )
Typical noise emission	<35dB	<35dB	<35dB	<35dB	<35dB	<35dB
Max. operation altitude	6, 560 ft (2000 m)	6, 560 ft (2000 m)	6, 560 ft (2000 m)	6, 560 ft (2000 m)	6, 560 ft (2000 m)	6, 560 ft (2000 m)
Internal consumption at night	<25W	<25W	<25W	<25W	<25W	<25W
Cooling method	Natural convection	Natural convection	Natural convection	Natural convection	Natural convection	Natural convection
Scalability	4	4	4	4	4	4
Safety and EMC	UL9540A, UL9540, UL1973, UL1741 SA, UL 1741 SB, UL1741 CRD, CSA C22.2 No.107.1-16, UL1998, UL1699B, HECO SRD-V2.0; IEEE1547-201 8, IEEE1547a-20 20, IEEE1547.1-20 20, Rule21; FCC part15 CLASS B	UL9540A, UL9540, UL1973, UL1741 SA, UL 1741 SB, UL1741 CRD, CSA C22.2 No.107.1-16, UL1998, UL1699B, HECO SRD-V2.0; IEEE1547-201 8, IEEE1547a-20 20, IEEE1547.1-20 20, Rule21; FCC part15 CLASS B	UL9540A, UL9540, UL1973, UL1741 SA, UL 1741 SB, UL1741 CRD, CSA C22.2 No.107.1-16, UL1998, UL1699B, HECO SRD-V2.0; IEEE1547-201 8, IEEE1547a-20 20, IEEE1547.1-20 20, Rule21; FCC part15 CLASS B	UL9540A, UL9540, UL1973, UL1741 SA, UL 1741 SB, UL1741 CRD, CSA C22.2 No.107.1-16, UL1998, UL1699B, HECO SRD-V2.0; IEEE1547-201 8, IEEE1547a-20 20, IEEE1547.1-20 20, Rule21; FCC part15 CLASS B	UL9540A, UL9540, UL1973, UL1741 SA, UL 1741 SB, UL1741 CRD, CSA C22.2 No.107.1-16, UL1998, UL1699B, HECO SRD-V2.0; IEEE1547-201 8, IEEE1547a-20 20, IEEE1547.1-20 20, Rule21; FCC part15 CLASS B	UL9540A, UL9540, UL1973, UL1741 SA, UL 1741 SB, UL1741 CRD, CSA C22.2 No.107.1-16, UL1998, UL1699B, HECO SRD-V2.0; IEEE1547-201 8, IEEE1547a-20 20, IEEE1547.1-20 20, Rule21; FCC part15 CLASS B
Mounting	Ground	Ground	Ground	Ground	Ground	Ground

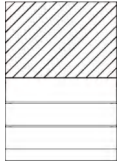
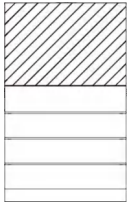
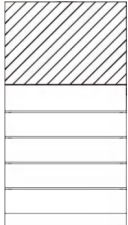
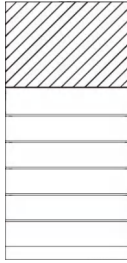
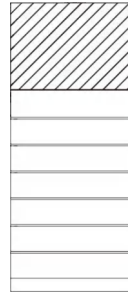

	mounting	mounting	mounting	mounting	mounting	mounting
Display	LED, App, Website	LED, App, Website	LED, App, Website	LED, App, Website	LED, App, Website	LED, App, Website
Communication	WiFi, 4G, LAN	WiFi, 4G, LAN	WiFi, 4G, LAN	WiFi, 4G, LAN	WiFi, 4G, LAN	WiFi, 4G, LAN
Interface	CAN2.0, RS485, Meter, CT, ISO alarm, SUNSPEC	CAN2.0, RS485, Meter, CT, ISO alarm, SUNSPEC	CAN2.0, RS485, Meter, CT, ISO alarm, SUNSPEC	CAN2.0, RS485, Meter, CT, ISO alarm, SUNSPEC	CAN2.0, RS485, Meter, CT, ISO alarm, SUNSPEC	CAN2.0, RS485, Meter, CT, ISO alarm, SUNSPEC
Warranty	12.5 years	12.5 years	12.5 years	12.5 years	12.5 years	12.5 years



<b>CUBE AC COUPLE INVERTER + BATTERIES</b>						
<b>Cube System</b>						
						
System module	US1AC-5.7-EQ L2	US1AC-5.7-EQ L3	US1AC-5.7-EQ L4	US1AC-5.7-EQ L5	US1AC-5.7-EQ L6	US1AC-5.7-EQ L7
<b>Energy Storage</b>						
Total energy	7.94	11.91	15.88	19.85	23.82	27.79
<b>AC OUTPUT</b>						
Max. continuous power (kW)	5.7	5.7	5.7	5.7	5.7	5.7
Max. continuous current (A)	23.8	23.8	23.8	23.8	23.8	23.8
Nominal frequency (Hz)	60	60	60	60	60	60
Load start capacity (A) LRA	48	72	96	110	110	110
Imbalance for split-phase loads	100%	100%	100%	100%	100%	100%
<b>General Data</b>						
Hybrid inverter Qty	1	1	1	1	1	1
Battery modules Qty	2	3	4	5	6	7
Base Qty	1	1	1	1	1	1
Dimension (W*H*D)	22.4inch*33.4inch*15inch (570mm*848mm*380mm)	22.4inch*38.8inch*15inch (570mm*986mm*380mm)	22.4inch*44.3inch*15inch (570mm*1124mm*380mm)	22.4inch*49.7inch*15inch (570mm*1262mm*380mm)	22.4inch*55.1inch*15inch (570mm*1400mm*380mm)	22.4inch*60.6inch*15inch (570mm*1538mm*380mm)
Weight	Inverter: 112.4lb (51kg); Battery module: 81.35lb (36.9kg);	Inverter: 112.44lb (51kg); Battery module: 81.35lb (36.9kg);	Inverter: 112.44lb (51kg); Battery module: 81.35lb (36.9kg);	Inverter: 112.44lb (51kg); Battery module: 81.35lb (36.9kg);	Inverter: 112.44lb (51kg); Battery module: 81.35lb (36.9kg);	Inverter: 112.44lb (51kg); Battery module: 81.35lb (36.9kg);

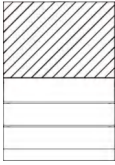
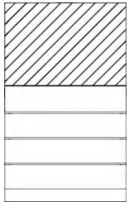
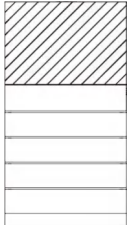
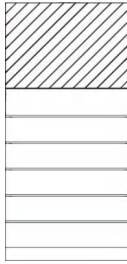
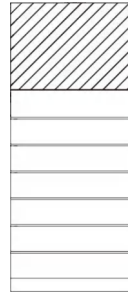

	Base: 7.72lb (3.5kg); Total: 282.9lb (128.3kg)	Base: 7.72lb (3.5kg); Total: 364.2lb (165.2kg)	Base: 7.72lb (3.5kg); Total: 445.6lb (202.1kg)	Base: 7.72lb (3.5kg); Total: 526.9lb (239kg)	Base: 7.72lb (3.5kg); Total: 608.3lb (275.9kg)	Base: 7.72lb (3.5kg); Total: 689.6lb (312.8kg)
Enclosure rating	Type 4X	Type 4X	Type 4X	Type 4X	Type 4X	Type 4X
Operation temperature range	14°F~+131°F (-10 °C ~ +55 °C) derating above 104°F(40°C)	14°F~+131°F (-10 °C ~ +55 °C) derating above 104°F(40°C)	14°F~+131°F (-10 °C ~ +55 °C) derating above 104°F(40°C)	14°F~+131°F (-10 °C ~ +55 °C) derating above 104°F(40°C)	14°F~+131°F (-10 °C ~ +55 °C) derating above 104°F(40°C)	14°F~+131°F (-10 °C ~ +55 °C) derating above 104°F(40°C)
Relative humidity	0-100% ( No Condensation )	0-100% ( No Condensation )	0-100% ( No Condensation )	0-100% ( No Condensation )	0-100% ( No Condensation )	0-100% ( No Condensation )
Typical noise emission	<35dB	<35dB	<35dB	<35dB	<35dB	<35dB
Max. operation altitude	6, 560 ft (2000 m)	6, 560 ft (2000 m)	6, 560 ft (2000 m)	6, 560 ft (2000 m)	6, 560 ft (2000 m)	6, 560 ft (2000 m)
Internal consumption at night	<25W	<25W	<25W	<25W	<25W	<25W
Cooling method	Natural convection	Natural convection	Natural convection	Natural convection	Natural convection	Natural convection
Scalability	4	4	4	4	4	4
Safety and EMC	UL9540A, UL9540, UL1973, UL1741 SA, UL 1741 SB, UL1741 CRD, CSA C22.2 No.107.1-16, UL1998, UL1699B, HECO SRD-V2.0; IEEE1547-201 8, IEEE1547a-20 20, IEEE1547.1-20 20, Rule21; FCC part15 CLASS B	UL9540A, UL9540, UL1973, UL1741 SA, UL 1741 SB, UL1741 CRD, CSA C22.2 No.107.1-16, UL1998, UL1699B, HECO SRD-V2.0; IEEE1547-201 8, IEEE1547a-20 20, IEEE1547.1-20 20, Rule21; FCC part15 CLASS B	UL9540A, UL9540, UL1973, UL1741 SA, UL 1741 SB, UL1741 CRD, CSA C22.2 No.107.1-16, UL1998, UL1699B, HECO SRD-V2.0; IEEE1547-201 8, IEEE1547a-20 20, IEEE1547.1-20 20, Rule21; FCC part15 CLASS B	UL9540A, UL9540, UL1973, UL1741 SA, UL 1741 SB, UL1741 CRD, CSA C22.2 No.107.1-16, UL1998, UL1699B, HECO SRD-V2.0; IEEE1547-201 8, IEEE1547a-20 20, IEEE1547.1-20 20, Rule21; FCC part15 CLASS B	UL9540A, UL9540, UL1973, UL1741 SA, UL 1741 SB, UL1741 CRD, CSA C22.2 No.107.1-16, UL1998, UL1699B, HECO SRD-V2.0; IEEE1547-201 8, IEEE1547a-20 20, IEEE1547.1-20 20, Rule21; FCC part15 CLASS B	UL9540A, UL9540, UL1973, UL1741 SA, UL 1741 SB, UL1741 CRD, CSA C22.2 No.107.1-16, UL1998, UL1699B, HECO SRD-V2.0; IEEE1547-201 8, IEEE1547a-20 20, IEEE1547.1-20 20, Rule21; FCC part15 CLASS B
Mounting	Ground mounting	Ground mounting	Ground mounting	Ground mounting	Ground mounting	Ground mounting

Display	LED, App, Website	LED, App, Website	LED, App, Website	LED, App, Website	LED, App, Website	LED, App, Website
Communication	WiFi, 4G, LAN	WiFi, 4G, LAN	WiFi, 4G, LAN	WiFi, 4G, LAN	WiFi, 4G, LAN	WiFi, 4G, LAN
Interface	CAN2.0, RS485, Meter, CT, ISO alarm, SUNSPEC	CAN2.0, RS485, Meter, CT, ISO alarm, SUNSPEC	CAN2.0, RS485, Meter, CT, ISO alarm, SUNSPEC	CAN2.0, RS485, Meter, CT, ISO alarm, SUNSPEC	CAN2.0, RS485, Meter, CT, ISO alarm, SUNSPEC	CAN2.0, RS485, Meter, CT, ISO alarm, SUNSPEC
Warranty	12.5 years	12.5 years	12.5 years	12.5 years	12.5 years	12.5 years

<b>CUBE AC COUPLE INVERTER + BATTERIES</b>						
<b>Cube System</b>						
						
System module	US1AC-7.6-EQ L2	US1AC-7.6-EQ L3	US1AC-7.6-EQ L4	US1AC-7.6-EQ L5	US1AC-7.6-EQ L6	US1AC-7.6-EQ L7
<b>Energy Storage</b>						
Total energy	7.94	11.91	15.88	19.85	23.82	27.79
<b>AC Output</b>						
Max. continuous power (kW)	5.76	7.6	7.6	7.6	7.6	7.6
Max. continuous current (A)	24	31.7	31.7	31.7	31.7	31.7
Nominal frequency (Hz)	60	60	60	60	60	60
Load start capacity (A) LRA	48	72	96	110	110	110
Imbalance for split-phase loads	100%	100%	100%	100%	100%	100%
CEC efficiency	96.5%	96.5%	96.5%	96.5%	96.5%	96.5%
<b>General Data</b>						
Hybrid inverter Qty	1	1	1	1	1	1
Battery modules Qty	2	3	4	5	6	7
Base Qty	1	1	1	1	1	1
Dimension (W*H*D)	22.4inch*33.4inch*15inch (570mm*848mm*380mm)	22.4inch*38.8inch*15inch (570mm*986mm*380mm)	22.4inch*44.3inch*15inch (570mm*1124mm*380mm)	22.4inch*49.7inch*15inch (570mm*1262mm*380mm)	22.4inch*55.1inch*15inch (570mm*1400mm*380mm)	22.4inch*60.6inch*15inch (570mm*1538mm*380mm)
Weight	Inverter: 112.44lb (51kg); Battery module: 81.35lb (36.9kg);	Inverter: 112.44lb (51kg); Battery module: 81.35lb (36.9kg);	Inverter: 112.44lb (51kg); Battery module: 81.35lb (36.9kg);	Inverter: 112.44lb (51kg); Battery module: 81.35lb (36.9kg);	Inverter: 112.44lb (51kg); Battery module: 81.35lb (36.9kg);	Inverter: 112.44lb (51kg); Battery module: 81.35lb (36.9kg);

	Base: 7.72lb (3.5kg); Total: 282.9lb (128.3kg)	Base: 7.72lb (3.5kg); Total: 364.2lb (165.2kg)	Base: 7.72lb (3.5kg); Total: 445.6lb (202.1kg)	Base: 7.72lb (3.5kg); Total: 526.9lb (239kg)	Base: 7.72lb (3.5kg); Total: 608.3lb (275.9kg)	Base: 7.72lb (3.5kg); Total: 689.6lb (312.8kg)
Enclosure rating	Type 4X	Type 4X	Type 4X	Type 4X	Type 4X	Type 4X
Operation temperature range	14°F~+131°F (-10 °C ~ +55 °C) derating above 104°F(40°C)	14°F~+131°F (-10 °C ~ +55 °C) derating above 104°F(40°C)	14°F~+131°F (-10 °C ~ +55 °C) derating above 104°F(40°C)	14°F~+131°F (-10 °C ~ +55 °C) derating above 104°F(40°C)	14°F~+131°F (-10 °C ~ +55 °C) derating above 104°F(40°C)	14°F~+131°F (-10 °C ~ +55 °C) derating above 104°F(40°C)
Relative humidity	0-100% ( No Condensation )	0-100% ( No Condensation )	0-100% ( No Condensation )	0-100% ( No Condensation )	0-100% ( No Condensation )	0-100% ( No Condensation )
Typical noise emission	<35dB	<35dB	<35dB	<35dB	<35dB	<35dB
Max. operation altitude	6, 560 ft (2000 m)	6, 560 ft (2000 m)	6, 560 ft (2000 m)	6, 560 ft (2000 m)	6, 560 ft (2000 m)	6, 560 ft (2000 m)
Internal consumption at night	<25W	<25W	<25W	<25W	<25W	<25W
Cooling method	Natural convection	Natural convection	Natural convection	Natural convection	Natural convection	Natural convection
Scalability	4	4	4	4	4	4
Safety and EMC	UL9540A, UL9540, UL1973, UL1741 SA, UL 1741 SB, UL1741 CRD, CSA C22.2 No.107.1-16, UL1998, UL1699B, HECO SRD-V2.0; IEEE1547-201 8, IEEE1547a-20 20, IEEE1547.1-20 20, Rule21; FCC part15 CLASS B	UL9540A, UL9540, UL1973, UL1741 SA, UL 1741 SB, UL1741 CRD, CSA C22.2 No.107.1-16, UL1998, UL1699B, HECO SRD-V2.0; IEEE1547-201 8, IEEE1547a-20 20, IEEE1547.1-20 20, Rule21; FCC part15 CLASS B	UL9540A, UL9540, UL1973, UL1741 SA, UL 1741 SB, UL1741 CRD, CSA C22.2 No.107.1-16, UL1998, UL1699B, HECO SRD-V2.0; IEEE1547-201 8, IEEE1547a-20 20, IEEE1547.1-20 20, Rule21; FCC part15 CLASS B	UL9540A, UL9540, UL1973, UL1741 SA, UL 1741 SB, UL1741 CRD, CSA C22.2 No.107.1-16, UL1998, UL1699B, HECO SRD-V2.0; IEEE1547-201 8, IEEE1547a-20 20, IEEE1547.1-20 20, Rule21; FCC part15 CLASS B	UL9540A, UL9540, UL1973, UL1741 SA, UL 1741 SB, UL1741 CRD, CSA C22.2 No.107.1-16, UL1998, UL1699B, HECO SRD-V2.0; IEEE1547-201 8, IEEE1547a-20 20, IEEE1547.1-20 20, Rule21; FCC part15 CLASS B	UL9540A, UL9540, UL1973, UL1741 SA, UL 1741 SB, UL1741 CRD, CSA C22.2 No.107.1-16, UL1998, UL1699B, HECO SRD-V2.0; IEEE1547-201 8, IEEE1547a-20 20, IEEE1547.1-20 20, Rule21; FCC part15 CLASS B
Mounting	Ground mounting	Ground mounting	Ground mounting	Ground mounting	Ground mounting	Ground mounting

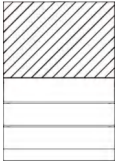
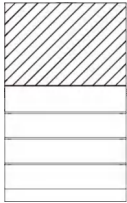
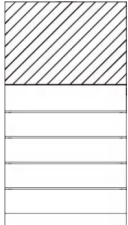
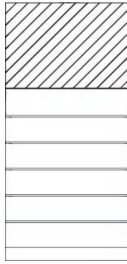
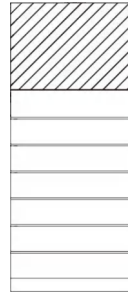

Display	LED, App, Website	LED, App, Website	LED, App, Website	LED, App, Website	LED, App, Website	LED, App, Website
Communication	WiFi, 4G, LAN	WiFi, 4G, LAN	WiFi, 4G, LAN	WiFi, 4G, LAN	WiFi, 4G, LAN	WiFi, 4G, LAN
Interface	CAN2.0, RS485, Meter, CT, ISO alarm, SUNSPEC	CAN2.0, RS485, Meter, CT, ISO alarm, SUNSPEC	CAN2.0, RS485, Meter, CT, ISO alarm, SUNSPEC	CAN2.0, RS485, Meter, CT, ISO alarm, SUNSPEC	CAN2.0, RS485, Meter, CT, ISO alarm, SUNSPEC	CAN2.0, RS485, Meter, CT, ISO alarm, SUNSPEC
Warranty	12.5 years	12.5 years	12.5 years	12.5 years	12.5 years	12.5 years

<b>CUBE AC COUPLE INVERTER (AC COUPLE-9.6) + BATTERIES</b>						
<b>Cube System</b>						
						
System module	US1AC-9.6-EQ L2	US1AC-9.6-EQ L3	US1AC-9.6-EQ L4	US1AC-9.6-EQ L5	US1AC-9.6-EQ L6	US1AC-9.6-EQ L7
<b>Energy Storage</b>						
Total energy	7.94	11.91	15.88	19.85	23.82	27.79
<b>AC Output</b>						
Max. continuous power (KW)	5.76	8.64	9.6	9.6	9.6	9.6
Max. continuous current (A)	24	36	40	40	40	40
Nominal frequency (Hz)	60	60	60	60	60	60
Load start capacity (A) LRA	48	72	96	110	110	110
Imbalance for split-phase loads	100%	100%	100%	100%	100%	100%
CEC efficiency	97.0%	97.0%	97.0%	97.0%	97.0%	97.0%
<b>General Data</b>						
Hybrid inverter Qty	1	1	1	1	1	1
Battery modules Qty	2	3	4	5	6	7
Base Qty	1	1	1	1	1	1
Dimension (W*H*D)	22.4inch*33.4inch*15inch (570mm*848mm*380mm)	22.4inch*38.8inch*15inch (570mm*986mm*380mm)	22.4inch*44.3inch*15inch (570mm*1124mm*380mm)	22.4inch*49.7inch*15inch (570mm*1262mm*380mm)	22.4inch*55.1inch*15inch (570mm*1400mm*380mm)	22.4inch*60.6inch*15inch (570mm*1538mm*380mm)
Weight	Inverter: 112.44lb (51kg); Battery module: 81.35lb (36.9kg);	Inverter: 112.44lb (51kg); Battery module: 81.35lb (36.9kg);	Inverter: 112.44lb (51kg); Battery module: 81.35lb (36.9kg);	Inverter: 112.44lb (51kg); Battery module: 81.35lb (36.9kg);	Inverter: 112.44lb (51kg); Battery module: 81.35lb (36.9kg);	Inverter: 112.44lb (51kg); Battery module: 81.35lb (36.9kg);

	Base: 7.72lb (3.5kg); Total: 282.9lb (128.3kg)	Base: 7.72lb (3.5kg); Total: 364.2lb (165.2kg)	Base: 7.72lb (3.5kg); Total: 445.6lb (202.1kg)	Base: 7.72lb (3.5kg); Total: 526.9lb (239kg)	Base: 7.72lb (3.5kg); Total: 608.3lb (275.9kg)	Base: 7.72lb (3.5kg); Total: 689.6lb (312.8kg)
Enclosure rating	Type 4X	Type 4X	Type 4X	Type 4X	Type 4X	Type 4X
Operation temperature range	14°F~+131°F (-10 °C ~ +55 °C) derating above 104°F(40°C)	14°F~+131°F (-10 °C ~ +55 °C) derating above 104°F(40°C)	14°F~+131°F (-10 °C ~ +55 °C) derating above 104°F(40°C)	14°F~+131°F (-10 °C ~ +55 °C) derating above 104°F(40°C)	14°F~+131°F (-10 °C ~ +55 °C) derating above 104°F(40°C)	14°F~+131°F (-10 °C ~ +55 °C) derating above 104°F(40°C)
Relative humidity	0-100% ( No Condensation )	0-100% ( No Condensation )	0-100% ( No Condensation )	0-100% ( No Condensation )	0-100% ( No Condensation )	0-100% ( No Condensation )
Typical noise emission	<35dB	<35dB	<35dB	<35dB	<35dB	<35dB
Max. operation altitude	6, 560 ft (2000 m)	6, 560 ft (2000 m)	6, 560 ft (2000 m)	6, 560 ft (2000 m)	6, 560 ft (2000 m)	6, 560 ft (2000 m)
Internal consumption at night	<25W	<25W	<25W	<25W	<25W	<25W
Cooling method	Natural convection	Natural convection	Natural convection	Natural convection	Natural convection	Natural convection
Scalability	4	4	4	4	4	4
Safety and EMC	UL9540A, UL9540, UL1973, UL1741 SA, UL 1741 SB, UL1741 CRD, CSA C22.2 No.107.1-16, UL1998, UL1699B, HECO SRD-V2.0; IEEE1547-201 8, IEEE1547a-20 20, IEEE1547.1-20 20, Rule21; FCC part15 CLASS B	UL9540A, UL9540, UL1973, UL1741 SA, UL 1741 SB, UL1741 CRD, CSA C22.2 No.107.1-16, UL1998, UL1699B, HECO SRD-V2.0; IEEE1547-201 8, IEEE1547a-20 20, IEEE1547.1-20 20, Rule21; FCC part15 CLASS B	UL9540A, UL9540, UL1973, UL1741 SA, UL 1741 SB, UL1741 CRD, CSA C22.2 No.107.1-16, UL1998, UL1699B, HECO SRD-V2.0; IEEE1547-201 8, IEEE1547a-20 20, IEEE1547.1-20 20, Rule21; FCC part15 CLASS B	UL9540A, UL9540, UL1973, UL1741 SA, UL 1741 SB, UL1741 CRD, CSA C22.2 No.107.1-16, UL1998, UL1699B, HECO SRD-V2.0; IEEE1547-201 8, IEEE1547a-20 20, IEEE1547.1-20 20, Rule21; FCC part15 CLASS B	UL9540A, UL9540, UL1973, UL1741 SA, UL 1741 SB, UL1741 CRD, CSA C22.2 No.107.1-16, UL1998, UL1699B, HECO SRD-V2.0; IEEE1547-201 8, IEEE1547a-20 20, IEEE1547.1-20 20, Rule21; FCC part15 CLASS B	UL9540A, UL9540, UL1973, UL1741 SA, UL 1741 SB, UL1741 CRD, CSA C22.2 No.107.1-16, UL1998, UL1699B, HECO SRD-V2.0; IEEE1547-201 8, IEEE1547a-20 20, IEEE1547.1-20 20, Rule21; FCC part15 CLASS B
Mounting	Ground mounting	Ground mounting	Ground mounting	Ground mounting	Ground mounting	Ground mounting

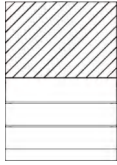
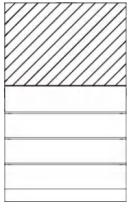
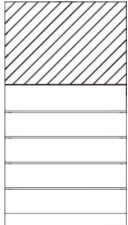
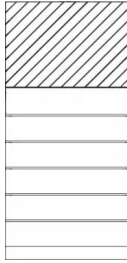
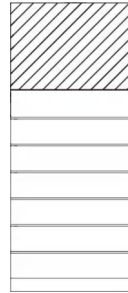

Display	LED, App, Website	LED, App, Website	LED, App, Website	LED, App, Website	LED, App, Website	LED, App, Website
Communication	WiFi, 4G, LAN	WiFi, 4G, LAN	WiFi, 4G, LAN	WiFi, 4G, LAN	WiFi, 4G, LAN	WiFi, 4G, LAN
Interface	CAN2.0, RS485, Meter, CT, ISO alarm, SUNSPEC	CAN2.0, RS485, Meter, CT, ISO alarm, SUNSPEC	CAN2.0, RS485, Meter, CT, ISO alarm, SUNSPEC	CAN2.0, RS485, Meter, CT, ISO alarm, SUNSPEC	CAN2.0, RS485, Meter, CT, ISO alarm, SUNSPEC	CAN2.0, RS485, Meter, CT, ISO alarm, SUNSPEC
Warranty	12.5 years	12.5 years	12.5 years	12.5 years	12.5 years	12.5 years

<b>CUBE AC COUPLE INVERTER + BATTERIES</b>						
<b>Cube System</b>						
						
System module	US1AC-11.4-E QL2	US1AC-11.4-E QL3	US1AC-11.4-E QL4	US1AC-11.4-E QL5	US1AC-11.4-E QL6	US1AC-11.4-E QL7
<b>Energy Storage</b>						
Total energy	7.94	11.91	15.88	19.85	23.82	27.79
<b>AC Output</b>						
Max. continuous power (kW)	5.76	8.64	11.4	11.4	11.4	11.4
Max. continuous current (A)	24	36	47.5	47.5	47.5	47.5
Nominal frequency (Hz)	60	60	60	60	60	60
Load start capacity (A) LRA	48	72	96	110	110	110
Imbalance for split-phase loads	100%	100%	100%	100%	100%	100%
CEC efficiency	97.0%	97.0%	97.0%	97.0%	97.0%	97.0%
<b>General Data</b>						
Hybrid inverter Qty	1	1	1	1	1	1
Battery modules Qty	2	3	4	5	6	7
Base Qty	1	1	1	1	1	1
Dimension (W*H*D)	22.4inch*33.4inch*15inch (570mm*848mm*380mm)	22.4inch*38.8inch*15inch (570mm*986mm*380mm)	22.4inch*44.3inch*15inch (570mm*1124mm*380mm)	22.4inch*49.7inch*15inch (570mm*1262mm*380mm)	22.4inch*55.1inch*15inch (570mm*1400mm*380mm)	22.4inch*60.6inch*15inch (570mm*1538mm*380mm)
Weight	Inverter: 112.44lb (51kg); Battery module: 81.35lb	Inverter: 112.44lb (51kg); Battery module: 81.35lb	Inverter: 112.44lb (51kg); Battery module: 81.35lb	Inverter: 112.44lb (51kg); Battery module: 81.35lb	Inverter: 112.44lb (51kg); Battery module: 81.35lb	Inverter: 112.44lb (51kg); Battery module: 81.35lb

	(36.9kg); Base: 7.72lb (3.5kg); Total: 282.9lb (128.3kg)	(36.9kg); Base: 7.72lb (3.5kg); Total: 364.2lb (165.2kg)	(36.9kg); Base: 7.72lb (3.5kg); Total: 445.6lb (202.1kg)	(36.9kg); Base: 7.72lb (3.5kg); Total: 526.9lb (239kg)	(36.9kg); Base: 7.72lb (3.5kg); Total: 608.3lb (275.9kg)	(36.9kg); Base: 7.72lb (3.5kg); Total: 689.6lb (312.8kg)
Enclosure rating	Type 4X	Type 4X	Type 4X	Type 4X	Type 4X	Type 4X
Operation temperature range	14°F~+131°F (-10 °C ~ +55 °C) derating above 104°F(40°C)	14°F~+131°F (-10 °C ~ +55 °C) derating above 104°F(40°C)	14°F~+131°F (-10 °C ~ +55 °C) derating above 104°F(40°C)	14°F~+131°F (-10 °C ~ +55 °C) derating above 104°F(40°C)	14°F~+131°F (-10 °C ~ +55 °C) derating above 104°F(40°C)	14°F~+131°F (-10 °C ~ +55 °C) derating above 104°F(40°C)
Relative humidity	0-100% ( No Condensation )	0-100% ( No Condensation )	0-100% ( No Condensation )	0-100% ( No Condensation )	0-100% ( No Condensation )	0-100% ( No Condensation )
Typical noise emission	<35dB	<35dB	<35dB	<35dB	<35dB	<35dB
Max. operation altitude	6, 560 ft (2000 m)	6, 560 ft (2000 m)	6, 560 ft (2000 m)	6, 560 ft (2000 m)	6, 560 ft (2000 m)	6, 560 ft (2000 m)
Internal consumption at night	<25W	<25W	<25W	<25W	<25W	<25W
Cooling method	Natural convection	Natural convection	Natural convection	Natural convection	Natural convection	Natural convection
Scalability	4	4	4	4	4	4
Safety and EMC	UL9540A, UL9540, UL1973, UL1741 SA, UL 1741 SB, UL1741 CRD, CSA C22.2 No.107.1-16, UL1998, UL1699B, HECO SRD-V2.0; IEEE1547-201 8, IEEE1547a-20 20, IEEE1547.1-20 20, Rule21; FCC part15 CLASS B	UL9540A, UL9540, UL1973, UL1741 SA, UL 1741 SB, UL1741 CRD, CSA C22.2 No.107.1-16, UL1998, UL1699B, HECO SRD-V2.0; IEEE1547-201 8, IEEE1547a-20 20, IEEE1547.1-20 20, Rule21; FCC part15 CLASS B	UL9540A, UL9540, UL1973, UL1741 SA, UL 1741 SB, UL1741 CRD, CSA C22.2 No.107.1-16, UL1998, UL1699B, HECO SRD-V2.0; IEEE1547-201 8, IEEE1547a-20 20, IEEE1547.1-20 20, Rule21; FCC part15 CLASS B	UL9540A, UL9540, UL1973, UL1741 SA, UL 1741 SB, UL1741 CRD, CSA C22.2 No.107.1-16, UL1998, UL1699B, HECO SRD-V2.0; IEEE1547-201 8, IEEE1547a-20 20, IEEE1547.1-20 20, Rule21; FCC part15 CLASS B	UL9540A, UL9540, UL1973, UL1741 SA, UL 1741 SB, UL1741 CRD, CSA C22.2 No.107.1-16, UL1998, UL1699B, HECO SRD-V2.0; IEEE1547-201 8, IEEE1547a-20 20, IEEE1547.1-20 20, Rule21; FCC part15 CLASS B	UL9540A, UL9540, UL1973, UL1741 SA, UL 1741 SB, UL1741 CRD, CSA C22.2 No.107.1-16, UL1998, UL1699B, HECO SRD-V2.0; IEEE1547-201 8, IEEE1547a-20 20, IEEE1547.1-20 20, Rule21; FCC part15 CLASS B
Mounting	Ground	Ground	Ground	Ground	Ground	Ground

	mounting	mounting	mounting	mounting	mounting	mounting
Display	LED, App, Website	LED, App, Website	LED, App, Website	LED, App, Website	LED, App, Website	LED, App, Website
Communication	WiFi, 4G, LAN	WiFi, 4G, LAN	WiFi, 4G, LAN	WiFi, 4G, LAN	WiFi, 4G, LAN	WiFi, 4G, LAN
Interface	CAN2.0, RS485, Meter, CT, ISO alarm, SUNSPEC	CAN2.0, RS485, Meter, CT, ISO alarm, SUNSPEC	CAN2.0, RS485, Meter, CT, ISO alarm, SUNSPEC	CAN2.0, RS485, Meter, CT, ISO alarm, SUNSPEC	CAN2.0, RS485, Meter, CT, ISO alarm, SUNSPEC	CAN2.0, RS485, Meter, CT, ISO alarm, SUNSPEC
Warranty	12.5 years	12.5 years	12.5 years	12.5 years	12.5 years	12.5 years

### 2.1.2 FOX Hub G2 Specification







FOX Hub G2 is an energy management unit with a smart circuits module, a backup loads module, a non-backup loads module, a generator assembly module and a communications module.

The appearance of the FOX Hub G2 is shown to the left.

Parameters of the FOX Hub G2 are described in the following table.

MODULE	FOX Hub G2
<b>INPUT FROM GRID</b>	
AC current input	200 A
Rated AC voltage	240 Vac
Rated AC power	48000 W
AC voltage range	211-264 Vac
AC frequency (nominal)	60 Hz
AC frequency range	57-63 Hz
Microgrid interconnection device rated current	200 A
Short-circuit breaking capacity	22 KA
Grid disconnection switchover time	<20 ms
<b>OUTPUT TO MAIN DISTRIBUTION PANEL</b>	
Maximum AC current output	200 A
AC L-L output voltage (nominal)	240 Vac
AC L-L output voltage range	211-264 Vac
AC frequency (nominal)	60 Hz
AC frequency range	57-63 Hz
AC L-N output voltage in backup (nominal)	120 V
AC L-N output voltage range in backup	105-132 V
AC frequency range in backup	55-65 Hz
Maximum number of Fox PowerQ units	4 #

Rated AC power	48000 W
<b>GENERATOR (OPTIONAL)</b>	
Maximum rated AC power	48000 W
AC voltage range	211-264 Vac
Maximum continuous input current	200 Adc
Dry contact switch voltage rating	250/30 Vac/Vdc
Dry contact switch current rating	0.5 A (250 Vac)/3 A(30 Vdc)
2-wire start switch	Yes
<b>TERMINAL (OPTIONAL)</b>	
Solar terminal	80 A
Fox ESS inverter terminal	80 A
Smart circuits 1, 2	80 A
Smart circuit 3	80 A
Non-backup load terminal	200 A
Backup load terminal	200 A
<b>ADDITIONAL FEATURES</b>	
Communication	CAN, RS485
Energy meter (for Import/Export)	0.5% Accuracy
<b>STANDARD COMPLIANCE</b>	
Safety	UL67,UL869A,UL916,UL1741,CSA22.2 NO.107
Emissions	FCC Part 15 Class B
<b>INSTALLATION SPECIFICATIONS</b>	
Supported inverters	FOX US Series
AC from grid conduit size/AWG range	2.5"Conduits/6 AWG-250 kcmil
AC generator input conduit size/AWG range	2.5"Conduits/6 AWG-250 kcmil
Communication conduit size/AWG range	1"Conduits/24 AWG-16 AWG
Weight	37.4 lbs/17 Kg
Cooling	Natural Convection
Noise	<35dB
Operating temperature range	-4 °F~+122 °F (-20 °C ~ +50 °C)
Protection rating	Type 3R
Dimensions (H*W*D)	26.2 in*17.4 in*6.2 in/ 665 mm*443 mm*156.6 mm
Warranty	Standard 12.5 years

	<p><b>Note!</b></p> <p>The FOX Hub G2 may not come with the capability to connect to smart circuit and generator. Please refer to the checkmarks on the shipping mark of the FOX Hub G2. If "smart circuit" or "generator" is checked, the FOX Hub G2 comes with the corresponding functions.</p>
	<h2>FOX Hub</h2>
	<p><b>MODEL: FOX Hub G2</b></p>
	<p>Date: 22W01   G.W: 23kg(51lb)   N.W: 18kg(40lb)</p>
	<p>Dimension(mm): 760(W)×540(H)×276(D)</p>
	<p>Factory Certification: ISO9001:2015   Safety/EMC Certification </p>
	<p><input type="checkbox"/>WILAN    <input type="checkbox"/>4GWILAN    <input type="checkbox"/>GENERATOR    <input type="checkbox"/>SMART CIRCUIT</p>
	<p>P/N: <b>30-403-00002-00</b></p>
	<p>S/N:  60AT2530211A002</p>
	<p> MADE IN CHINA</p>

Shipping mark

## 2.2 System Installation

### 2.2.1 System Installation Space

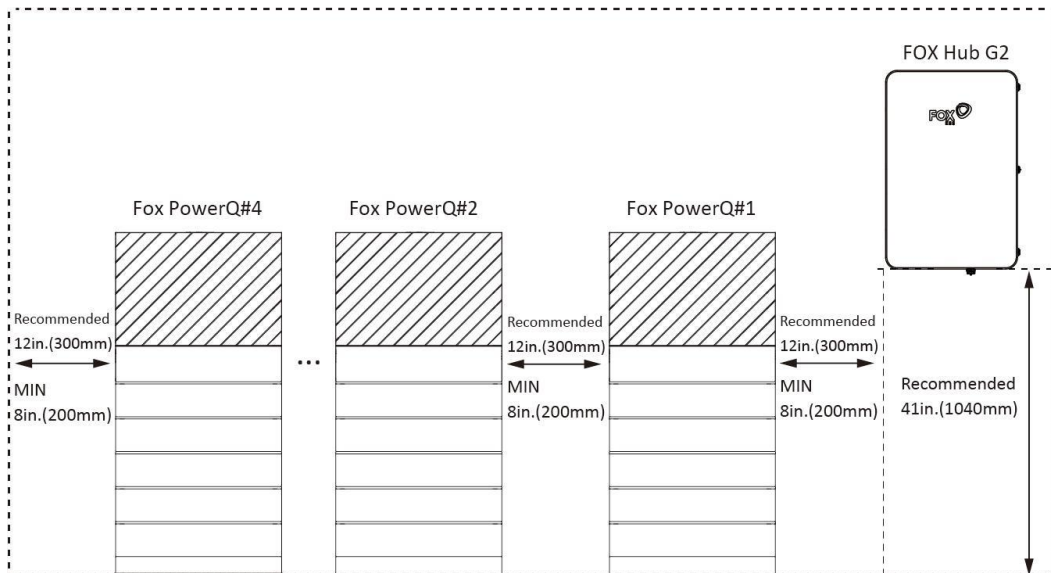

	<p><b>Note!</b></p> <p>The recommended installation height of the FOX Hub G2 is 41 in. (1040 mm).</p>
---	---

## 2.2.2 Installation Steps

### FOX Hub G2 Installation Steps

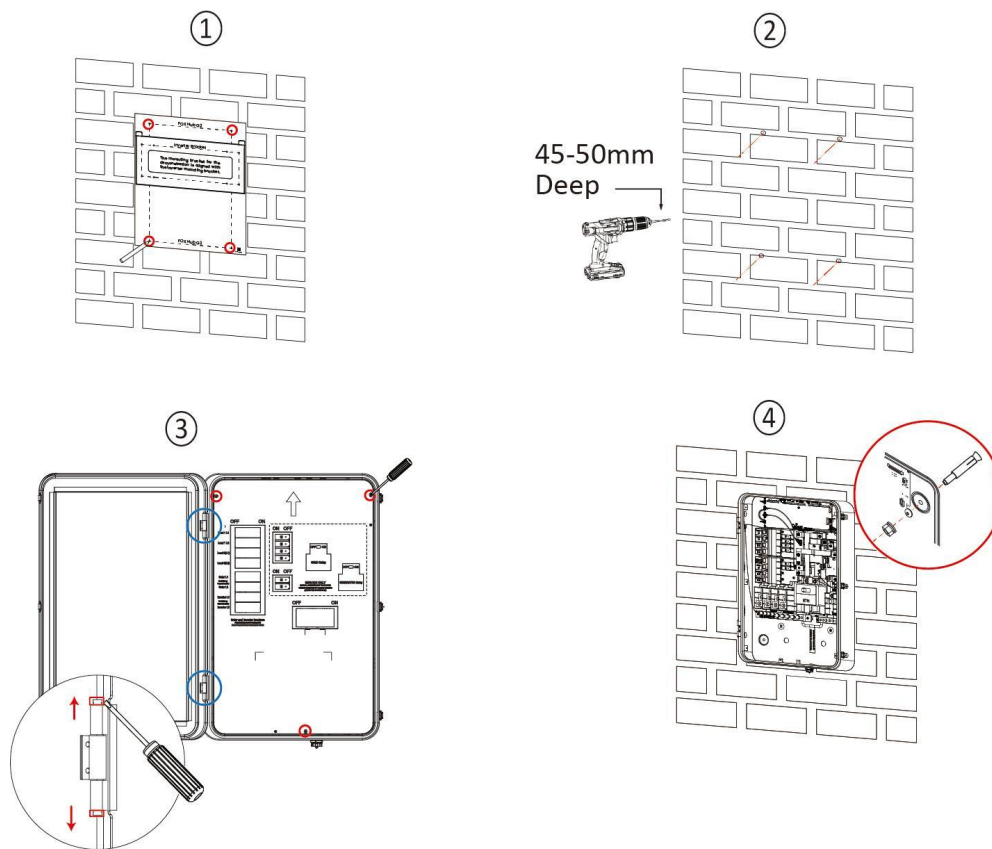

Fox PowerQ Installation Steps

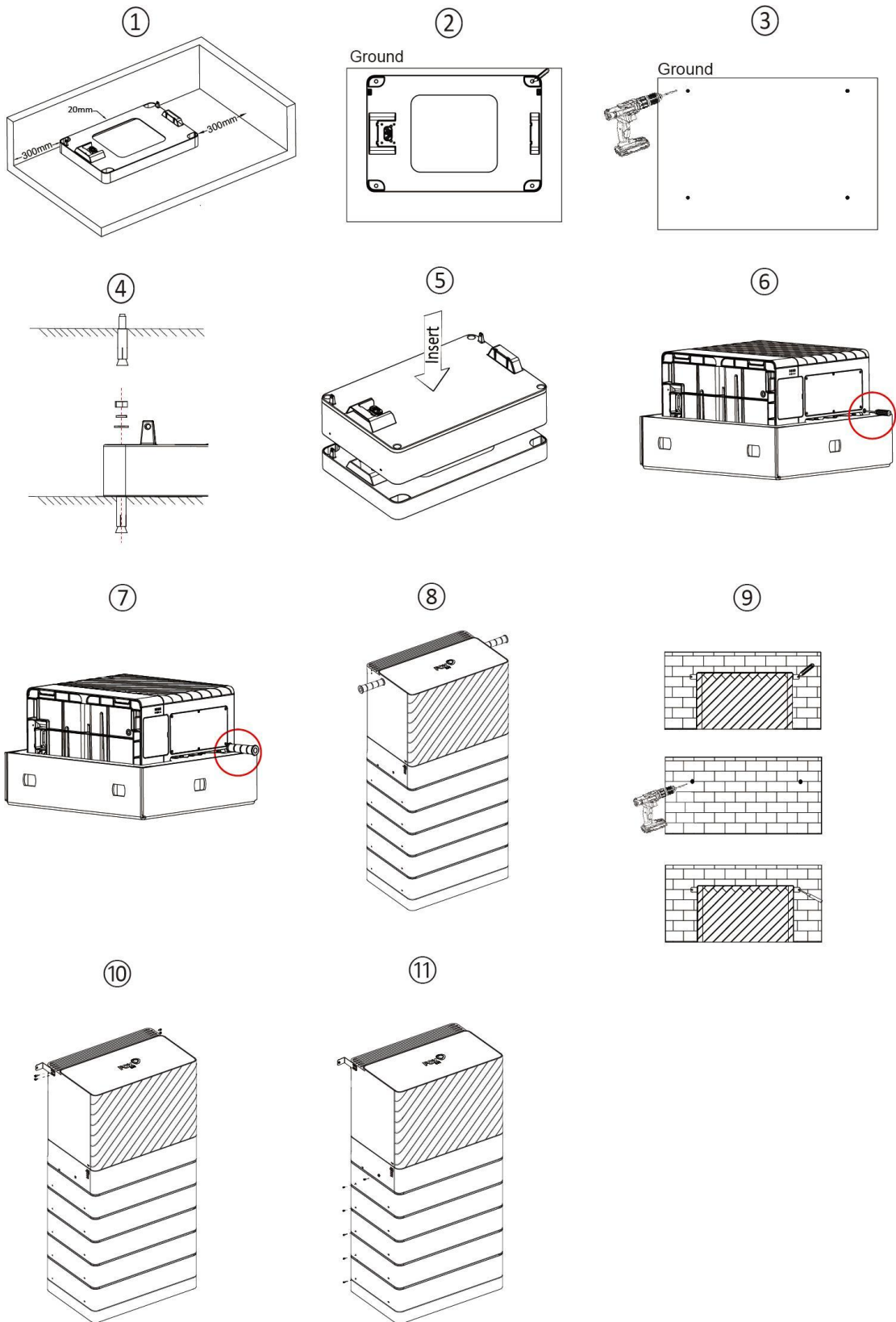

2.2.3 Installing FOX Hub G2 as Service Panel or not as Service Panel

- ① When the FOX Hub G2 is used as the service panel,



- a. main breaker (Eaton CSR2200N) and line side barriers (Eaton TICSR300C) need to be installed;

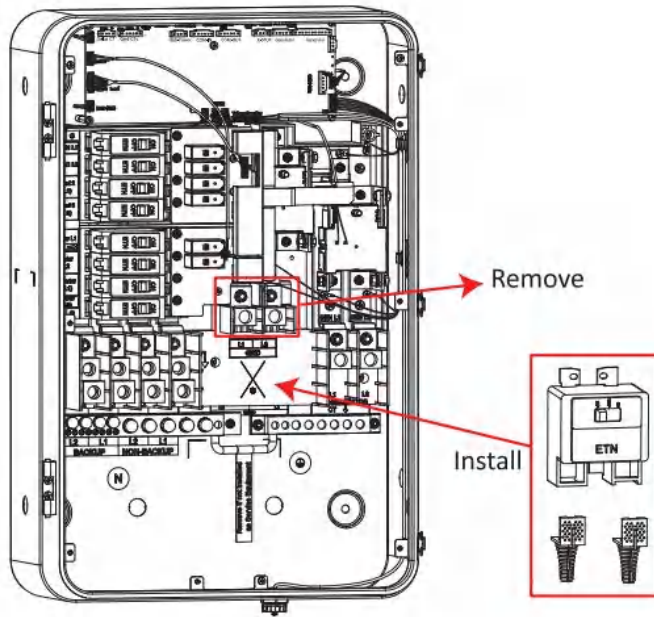

- b. labels of “SERVICE DISCONNECT” and “SUITABLE FOR USE AS SERVICE EQUIPMENT ONLY IN USA WHEN EQUIPPED WITH MAIN BREAKER” shall be applied to the black protection cover.

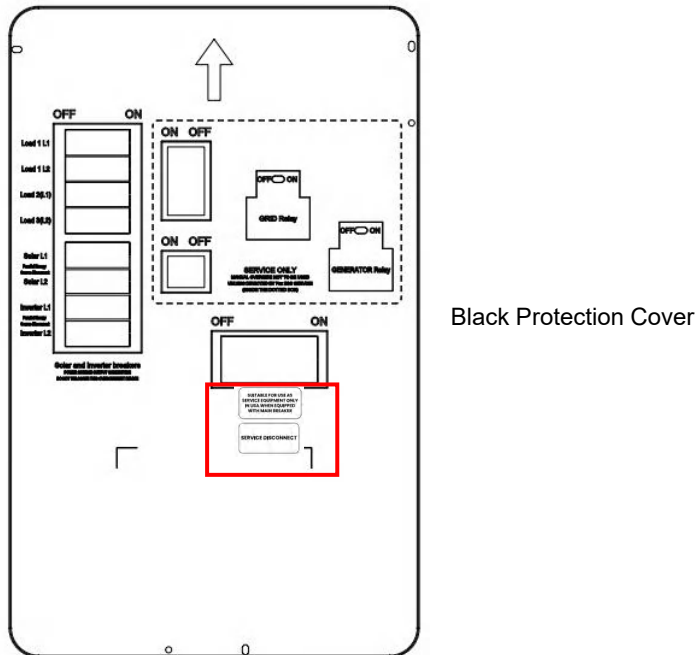

- ② When the FOX Hub G2 is not used as the service panel, bonding jumper needs to be removed.

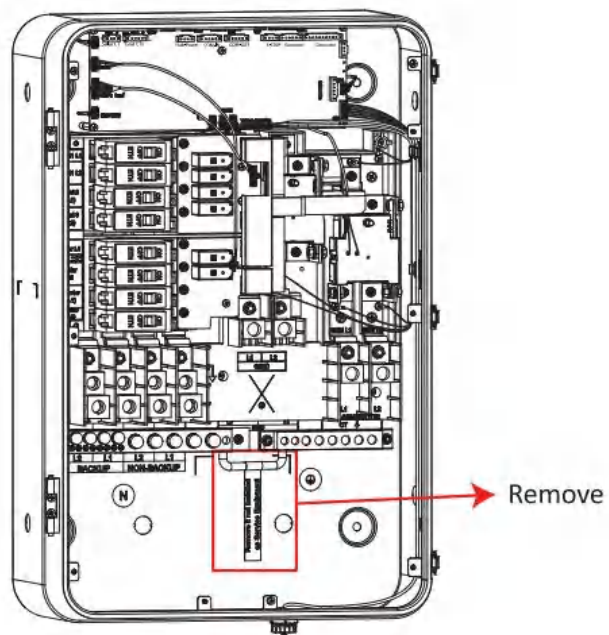

## 2.3 Backup Options

The backup options of the Fox PowerQ energy storage system include whole-home backup and partial backup. The selection of load for different options should be finalized during the system design phase.

	<p><b>Note!</b></p> <p>The standby generator recommended is GENERAC Guardian Series.</p>
---	--

### Whole-home Backup

To enable the whole-home backup option, connect all household loads (excluding smart loads) to the backup port of the FOX Hub G2 via the Main Panel. This allows the storage system to support all household energy loads in case of a grid failure.

Whole-home Backup (DC Couple)

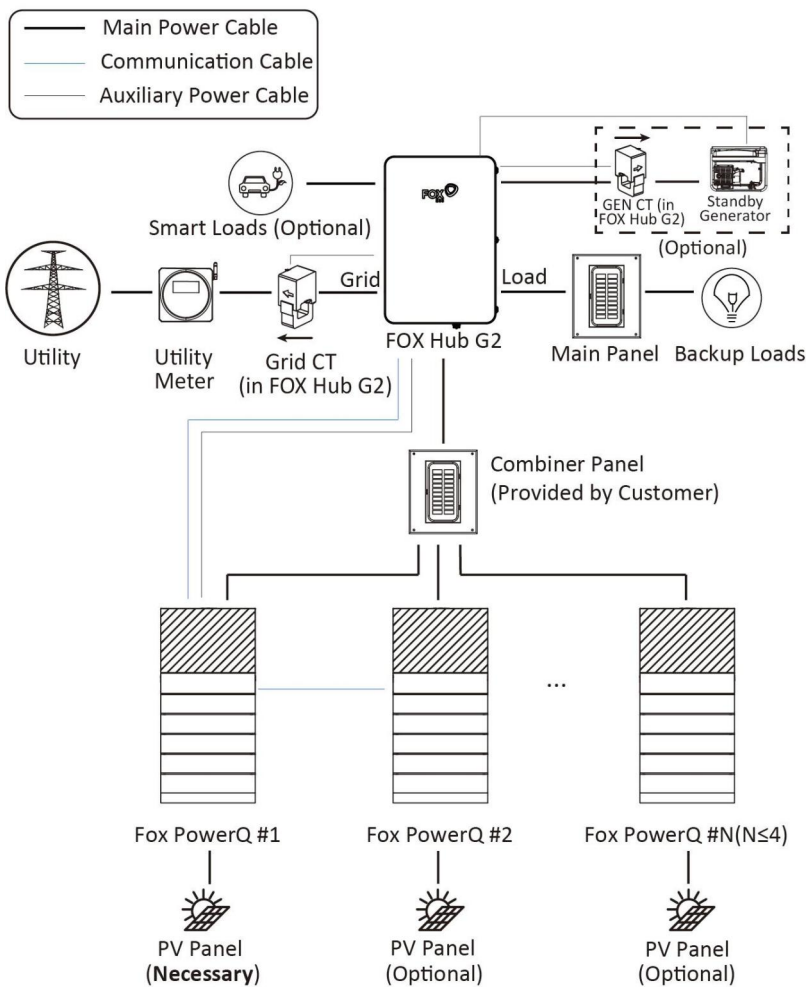

Whole-home Backup (AC Couple)

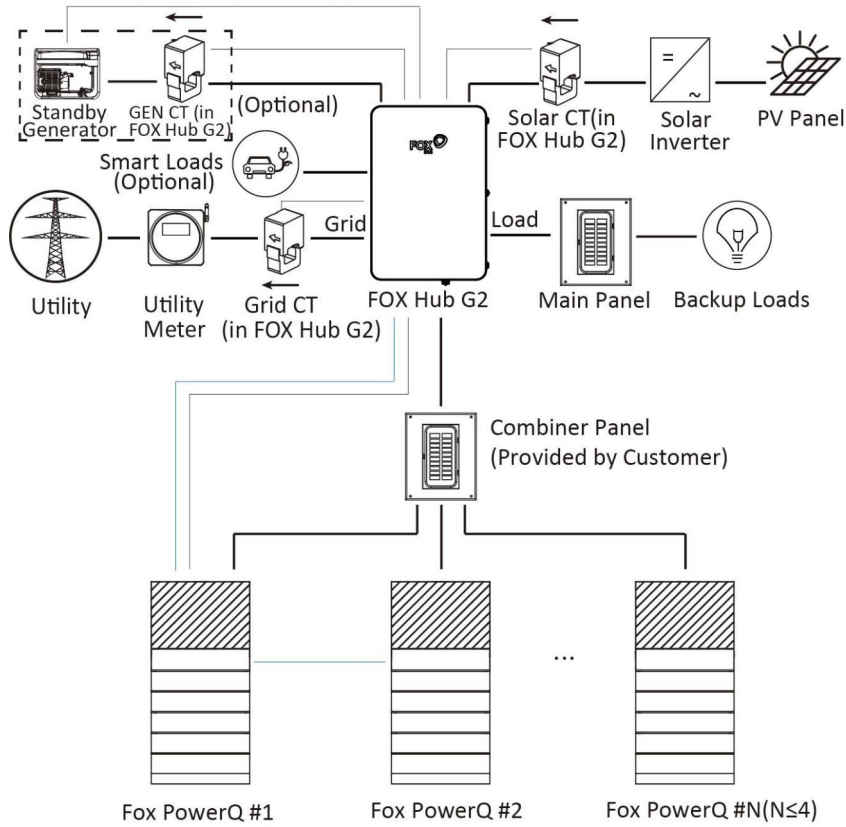
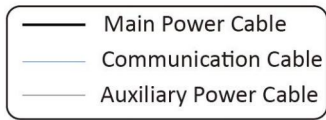

**Partial Backup**

To configure the system in a partial backup mode, it is necessary to identify the backup loads beforehand. For this purpose, connect the backup loads to the backup panel and the non-backup loads (i.e., non-essential loads) to the main panel. In case of a grid failure, the storage system will only power the backup loads during the outage. This ensures that the backup loads get priority power supply while the non-backup loads remain unpowered.

Partial-home Backup (DC Couple) (FOX Hub G2 as Service Panel)

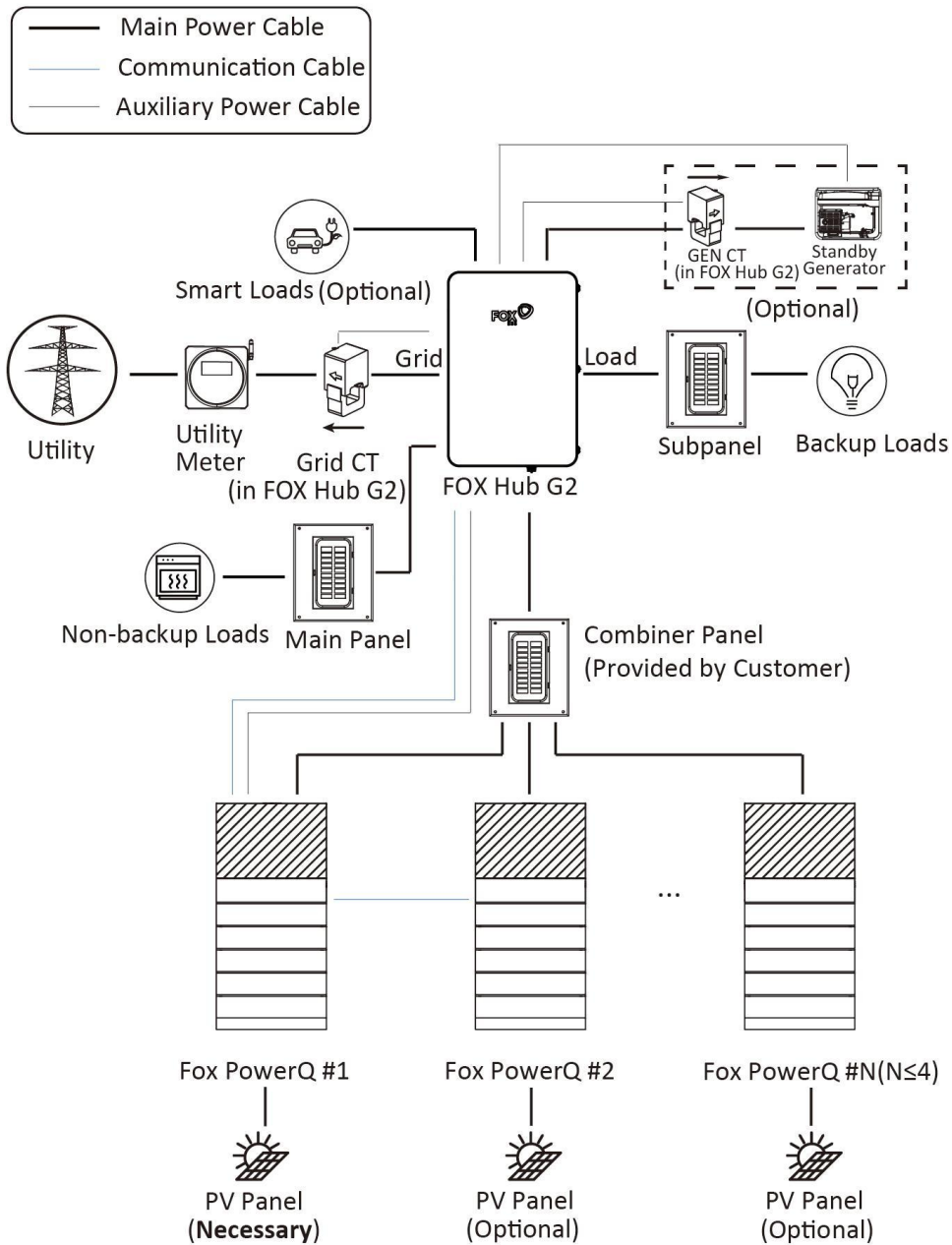

Partial-home Backup (DC Couple) (FOX Hub G2 not as Service Panel)

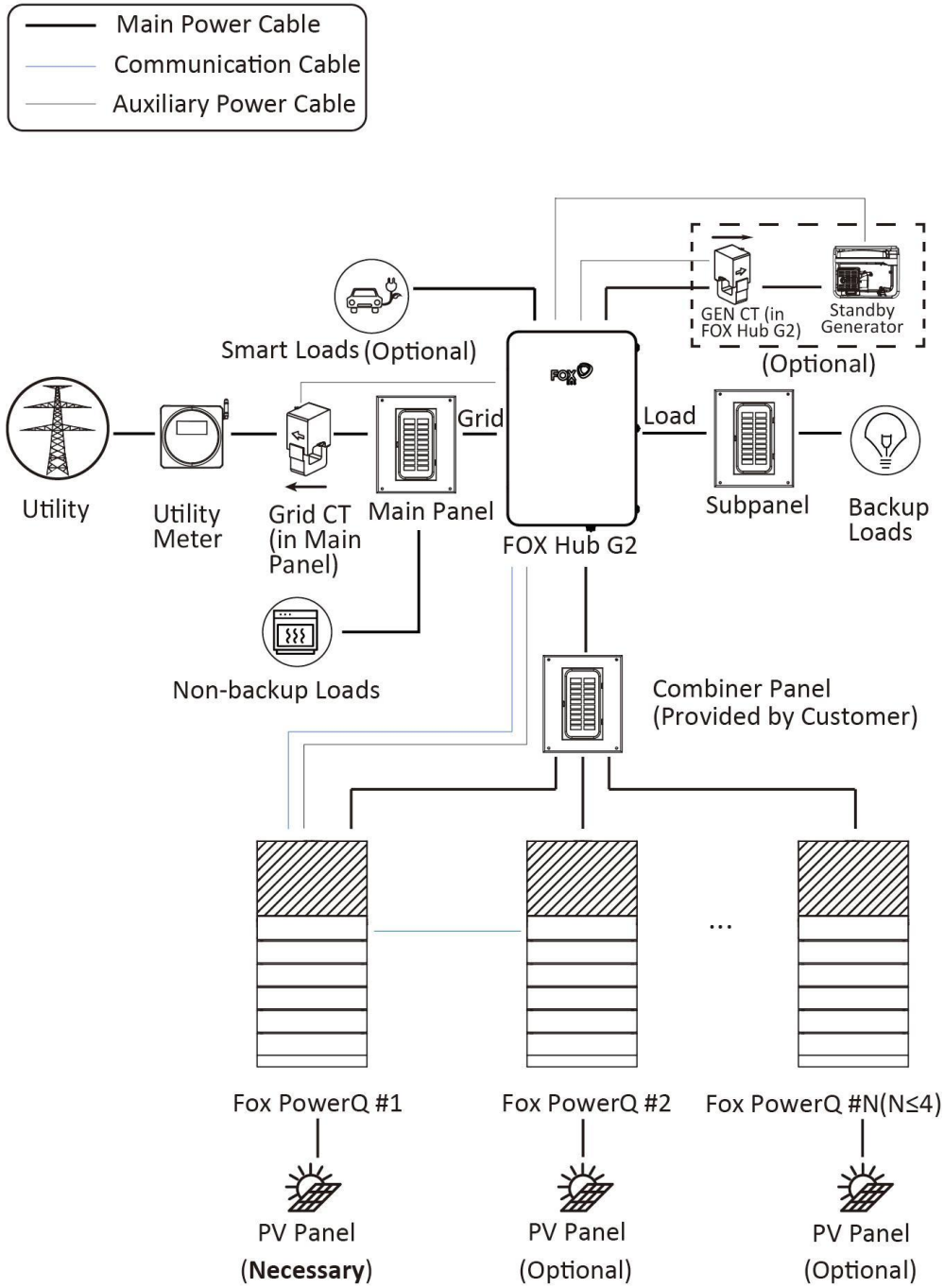

Partial-home Backup (AC Couple) (FOX Hub G2 as Service Panel)

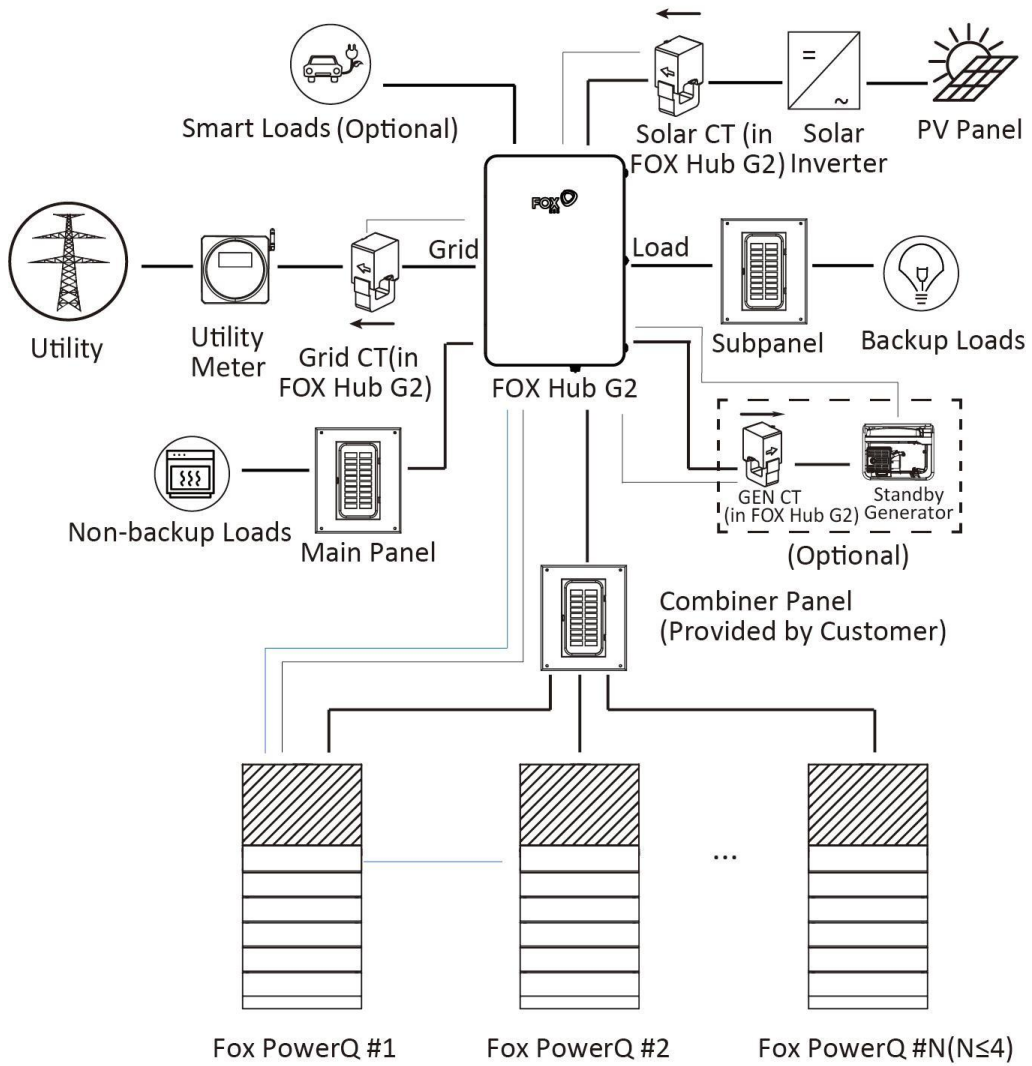
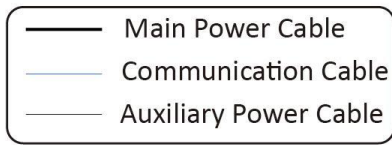

Partial-home Backup (AC Couple) (FOX Hub G2 not as Service Panel)

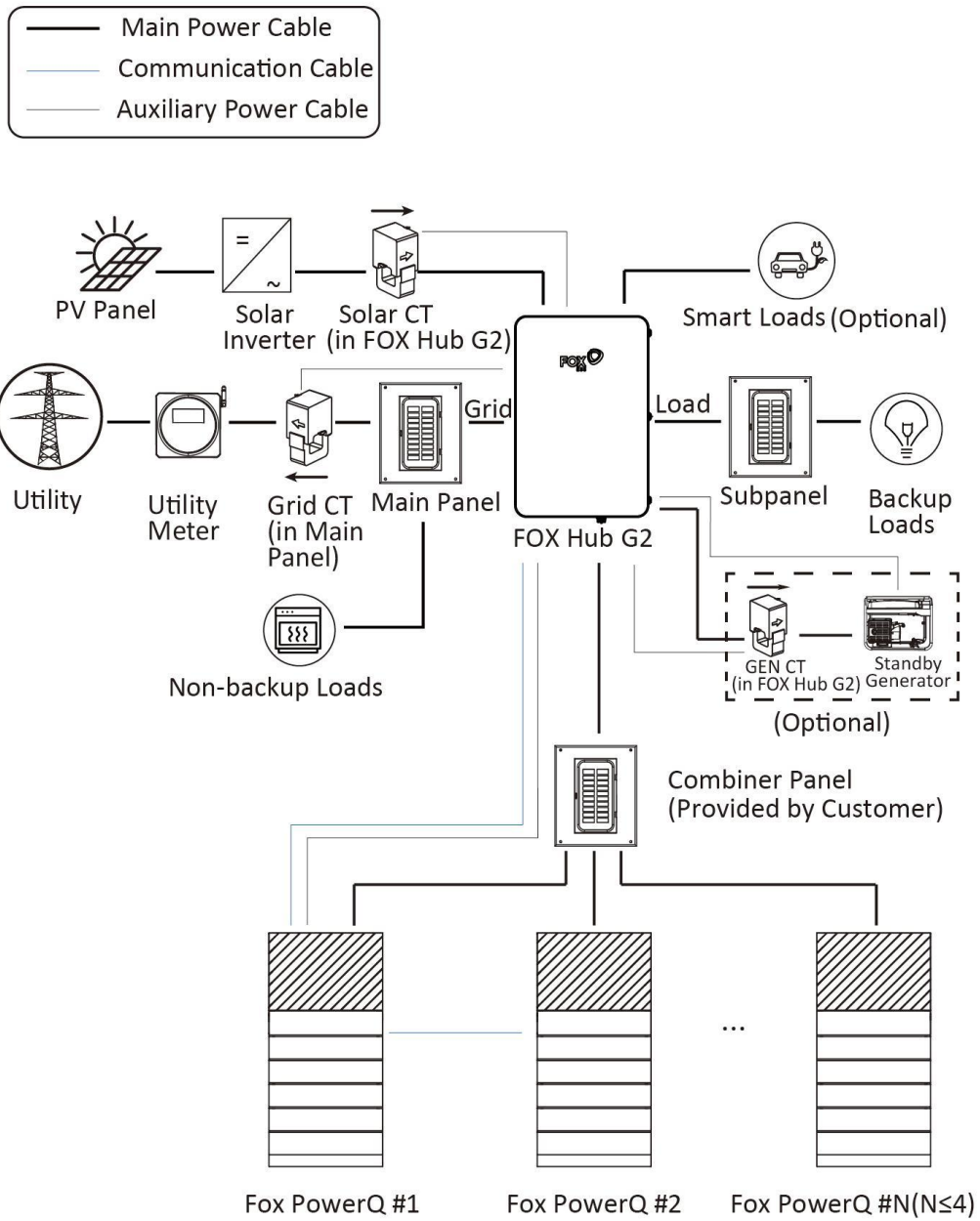



## 2.4 Operating Mode

The Fox PowerQ energy storage system supports several operating modes, including Mandatory, Self-Power, Time of Use (TOU), and Backup Standby.

### Mandatory Mode

When the operating mode is set to the Mandatory, the system will compulsively charge the battery to 100% State of Charge (SOC) from solar and the utility grid, or discharge the battery to power for the household loads.

### Self-Power Mode

When the operating mode is set to the Self-Power, the system is designed to store any surplus electricity generated by the solar system after meeting the power requirements of the household loads. In situations where the solar production is insufficient to meet the total household load, the system will provide additional power support by discharging stored energy, thereby reducing the dependency on grid electricity. If the backup reserve's State of Charge (SOC) is set to 100%, the system will prioritize charging the battery to its maximum capacity exclusively from solar power and will not discharge energy. In the event of a grid failure, the system will automatically switch to powering the household loads using the stored energy.

### Time of Use (TOU) Mode

If the electricity rate in the homeowner's area changes throughout the day, based on demand, the homeowner can select the TOU mode to customize the on-peak and off-peak times according to the electricity rate. During the on-peak times, when the electricity rates are higher, the system will prioritize the utilization of solar power and energy stored in the batteries. Throughout the off-peak periods, when electricity rates are lower, the system will utilize a combination of power sources including the grid, the PV system, and the batteries in an optimized manner to meet the household loads.

If the SOC value of the backup reserve is set 100%, during the off-peak periods, the system will focus on charging the batteries to their full capacity using solar power and will not discharge any energy. In the event of a grid failure, the system will automatically switch to powering the household loads.

- **Peak:** highest electric power price
- **Off-peak:** lowest electric power price
- **Shoulder:** the rest hours

TOU provides users with two options:

- Solar power to storage first
- Solar power to family loads first

Functional Logic of TOU Mode			
Charging/Discharging	Electricity Rate	Storage First	Family Loads First
Charging	Peak	The solar power will be prioritized to power the home, while the excess will charge the BAT.	The solar power will be prioritized to power the home, while the excess will charge the BAT.
	Off-peak	The solar power will be prioritized to charge the BAT, while the excess	The solar power will be prioritized to charge the BAT, while the excess will

		will power the home.	power the home.
	Shoulder	The solar power will be prioritized to charge the BAT, while the excess will power the home.	The solar power will be prioritized to power the home, while the excess will charge the BAT.
Discharging	Peak	Power supply priority: Solar > BAT > Grid	
	Off-peak	The BAT does not discharge.	
	Shoulder	The BAT does not discharge.	Power supply priority: Solar > BAT > Grid

**Backup Standby Mode**

When the grid is off, the system will supply emergency power from PV or battery to the home loads (Battery is necessary in off-grid mode).

In the event of a grid failure, the battery will automatically power the household loads. Once the grid power is restored, the system will seamlessly transition back to charging the battery from both solar and the utility grid.

**2.5 Key Functions**

**Emergency Stop**

In an emergency, manually turn off the E-STOP switch, if installed. Otherwise remove the E-STOP switch. The Fox PowerQ energy storage system shuts down after the E-STOP is triggered.

	<p><b>Note!</b> After the emergency shutdown, the home will lose power.</p>
---	---

**On-grid to Off-grid**

In the event of a grid failure or abnormality, the system will seamlessly transition to off-grid mode. In this mode, the household loads will be powered by a combination of solar energy, a connected generator (if available), and the system itself. The system ensures uninterrupted power supply to the household loads by utilizing these alternative power sources when grid power is not available or reliable.

**Off-grid to On-grid**

When the grid is restored, the system will automatically switch to on-grid mode. In this mode, the household loads will be powered by a combination of the grid, solar system, generator (if connected), and the Fox PowerQ energy storage system.

**Off-grid FW Function**

In off-grid operation, when the output power of the photovoltaic system exceeds the maximum power that the Fox PowerQ can absorb, the Fox PowerQ will increase the output AC voltage frequency based on the current operating conditions and the rated frequency. The photovoltaic system monitors the AC voltage frequency, and once it exceeds the rated frequency, the photovoltaic system limits the output power, which is known as frequency-active power derating control. This ensures that the system can balance the excess energy generated by the photovoltaic system during off-grid operation and avoids overloading the energy storage system.

**Full Charge Protection**

When the Fox PowerQ energy storage system is off-grid, the relay in the Fox PowerQ will be automatically turned off as soon as one battery is full (SOC=100%). After the Fox PowerQ energy

storage system meets the recovery conditions, the relay in the Fox PowerQ will be automatically turned on.

### **Automatic Black Start**

When solar power is insufficient, the grid power is unavailable, and the battery's available power is depleted, the smart loads will be automatically disconnected and the system will enter sleep mode, awaiting a black start attempt.

The system will initiate automatic start-up at predetermined times every day. In case of sufficient solar energy supply, the electricity generated by the photovoltaic system will charge the battery. However, if the solar power is insufficient, the system will return to sleep mode, awaiting the next scheduled automatic start-up.

### **Smart Loads**

The Fox PowerQ energy storage system provides three smart loads which can be controlled with the FoxCloud US app based on their personalized needs. This helps minimize household expenses while on-grid and saves battery consumption while off-grid.

#### **On-grid**

Based on local peak-valley settings and personal habits (such as pumping water into the swimming pool or charging the EVs), users may set a time plan for economical power usage through the FoxCloud US app. One or two time periods may be set for every 24 hours, to achieve the most economical use of electricity for smart loads.

#### **Off-grid**

Users may control the on/off status of smart loads by creating a time plan and setting a State of Charge (SOC) threshold. Users may set a SOC threshold (between 10% and 100%) based on the backup sustainability of the smart loads on the FoxCloud US app, where a lower SOC value means a longer backup period for the smart load. When the actual SOC falls below the set threshold, or the time is outside the time period set in the time plan, the smart load will be turned OFF.

The smart loads will not be reconnected until the Fox PowerQ actual SOC is 10% higher than the SOC threshold. For example, if the SOC threshold is set to 25%, the smart loads will not be reconnected until SOC reaches 35%.

#### **Manual Control**

Users may control the on/off status of the smart loads through the FoxCloud US app. The manual control of the smart loads on/off status has higher operation priority, so that the current time schedule can be overridden, disabled, and reactivated in the next time period.

The smart loads module can remotely control the on/off status of three smart loads, which may be set and controlled separately. Smart load 1 is only used for 240V loads without a neutral wire. No device requiring a neutral wire should be connected to smart load 1. Smart load 2 and smart load 3 may be set flexibly based on user needs and the configuration on the FoxCloud US app.



#### **Note!**

Circuit breaker cannot be relied on to provide overload protection when installed below 0 degree C. Separated overload protection shall be provided as required CEC and NEC if ambient temperature is below 0 degree C.

### 3 LED Lightening Descriptions

For Inverter Lightening

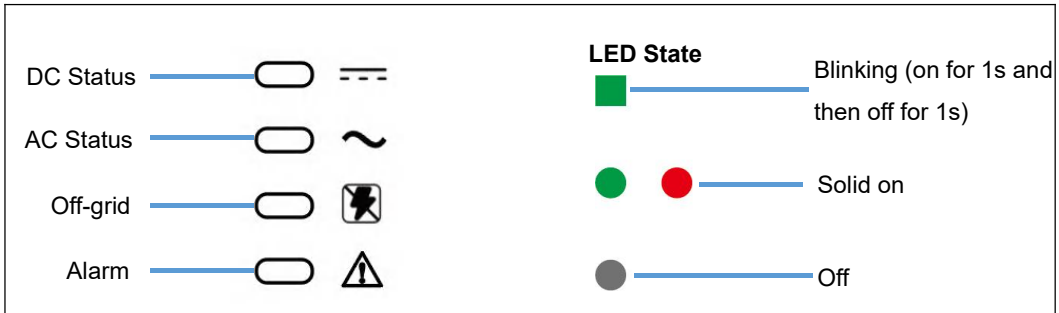





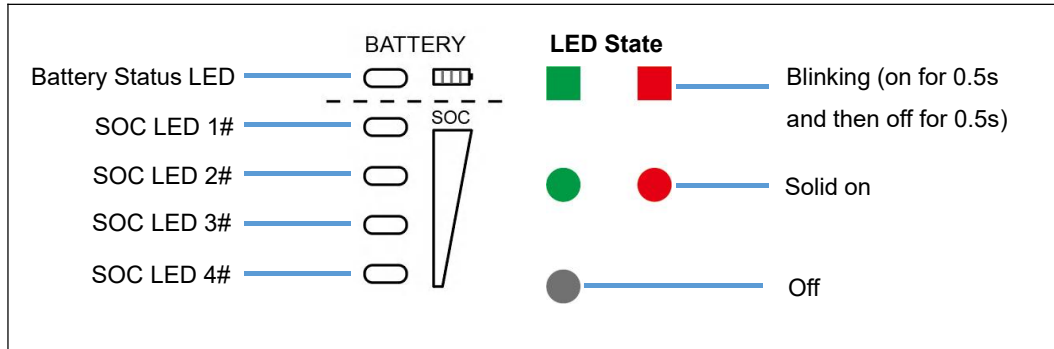









































































































Status				Meaning
				N/A
				The PCS is running in on-grid state and exporting power to the power grid.
				The DC is on and the AC is off in on-grid mode.
				The DC is off and the AC is on.
				The DC is on, the AC is on, and the PCS is starting up.
				Both the DC and AC are off in on-grid mode.
				The PCS is running in backup state.
				The DC is on and the PCS has no output in backup state.
				Both the DC and AC are off in backup state.
				Both the DC and AC are off.

























**For Battery Lightening**



SOC	Battery Status LED	SOC LED 1#	SOC LED 2#	SOC LED 3#	SOC LED 4#
100%>=SOC>=75%	Standby				
75%>SOC>=50%					
50%>SOC>=25%					
25%>SOC>=0%					
100%>=SOC>=75%	Discharge				
75%>SOC>=50%					
50%>SOC>=25%					
25%>SOC>=0%					
100%>=SOC>=75%	Charge				
75%>SOC>=50%					
50%>SOC>=25%					
25%>SOC>=0%					

Fault	Battery Status LED	SOC LED 1#	SOC LED 2#	SOC LED 3#	SOC LED 4#
Under Voltage Fault					
Over Voltage Fault					
Over Temperature Fault					

Fault	Battery Status LED	SOC LED 1#	SOC LED 2#	SOC LED 3#	SOC LED 4#
Under Temperature Fault					
Discharge Over Current					
Charge Over Current					
Discharge Over Power					
Charge Over Power					
Pre-charge Failed					
Short Circuit Protection					
AFE Communication Failed					
Module Addressing Failed					
IVU Communication Failed					
BMU Communication Failed					
PCS Communication Failed					
HVB FUSE Fault					
Module FUSE Fault					
Power Failed					
Internal Total Voltage Sampling Failed					
Temperature Sampling Failed					
Relay Adhesion					
Relay Not Close					
Relay Drive Failed					
Single Cell "0V" Fault					
Temperature High Permanent Failed					

Fault	Battery Status LED	SOC LED 1#	SOC LED 2#	SOC LED 3#	SOC LED 4#
Single Voltage High Permanently					
SOH Low Protection					
AFE Failed (UV/OV/UT/OT)					
Shutdown Failed					
Other Faults					

## 4 System Remote Operation and Monitoring

The FoxCloud US app provides remote operation and monitoring of the whole house energy system. It allows personalized household electricity plans to make your life easier.

The home screen of the FoxCloud US app displays real-time data from the Fox PowerQ energy storage system to help you understand the working status of your home power system. Please scan the following QR code to refer to the **FoxCloud US App User Manual** for more information.

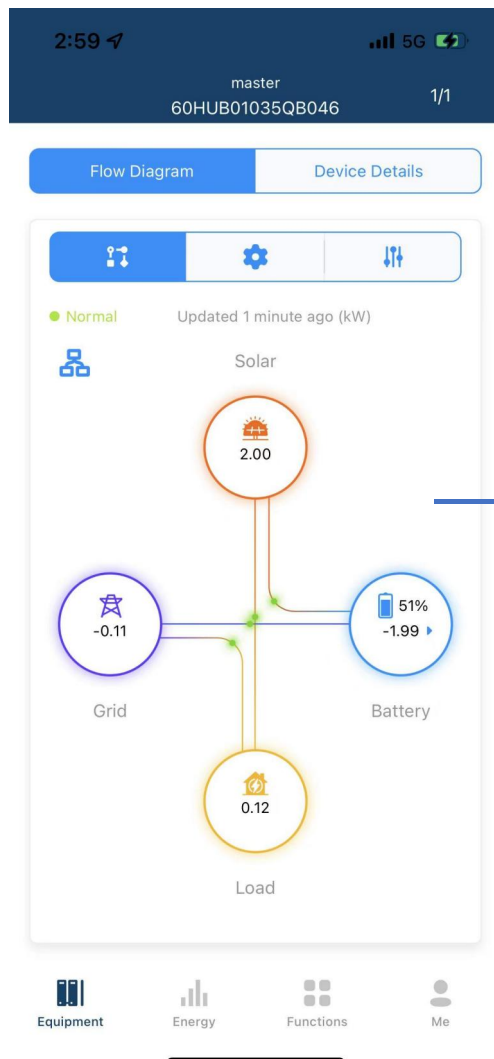

The working status of each energy source in the home.



## 5 Service and Maintenance

This section contains information and procedures for solving possible problems with the Fox PowerQ energy storage system and provides you with troubleshooting tips to identify and solve most problems that can occur.

### 5.1 Troubleshooting

Item	Alarm Number	Alarm Name	Alarm Severity	Alarm Action	Possible Cause	Suggestion
1	1025	Grid Overvoltage	Major	Shutdown, alarm reporting, and automatic recovery after the fault is rectified.	The grid voltage RMS value exceeds the higher threshold specified for HVRT.	<ol style="list-style-type: none"> <li>1. If the alarm is triggered accidentally, it may be due to temporary abnormalities in the power grid. The Fox PowerQ will automatically recover after the power grid has resumed normal functioning.</li> <li>2. Check whether the grid connection voltage exceeds the upper threshold. If so, contact the local power operator.</li> <li>3. If you have confirmed that the grid connection voltage exceeds the upper threshold and have obtained the consent of the local power operator, modify the overvoltage protection threshold.</li> </ol>
2	1026	Grid Transient Overvoltage	Major	Shutdown, alarm reporting, and automatic recovery after the fault is rectified.	The grid voltage peak value exceeds the higher threshold specified for HVRT.	<ol style="list-style-type: none"> <li>1. If the alarm is triggered accidentally, it may be due to temporary abnormalities in the power grid. The Fox PowerQ will automatically recover after the power grid has resumed normal functioning.</li> <li>2. If the alarm is triggered frequently, check whether the grid voltage is within the acceptable range. If not, contact the local power operator. If so, modify the power grid overvoltage protection threshold with the consent of the local power operator.</li> </ol>
3	1027	Grid Undervoltage	Major	Shutdown, alarm reporting, and automatic recovery after the fault is rectified.	The grid voltage rms value is below the lower threshold specified for LVRT.	<ol style="list-style-type: none"> <li>1. If the alarm is triggered accidentally, it may be due to temporary abnormalities in the power grid. The Fox PowerQ will automatically recover after the power grid has resumed normal functioning.</li> <li>2. If the alarm is triggered frequently, check whether the grid voltage is within the acceptable range. If not, contact the local power operator. If so, modify the power grid undervoltage protection threshold with the</li> </ol>

Item	Alarm Number	Alarm Name	Alarm Severity	Alarm Action	Possible Cause	Suggestion
						consent of the local power operator. 3. If the fault persists for a long time, check the connection between the AC switch and the output power cable.
4	1028	Grid Voltage Low	Major	Shutdown, alarm reporting, and automatic recovery after the fault is rectified.	The grid voltage rms value is below the lower threshold specified for LVRT.	<ol style="list-style-type: none"> <li>1. If the alarm is triggered accidentally, it may be due to temporary abnormalities in the power grid. The Fox PowerQ will automatically recover after the power grid has resumed normal functioning.</li> <li>2. If the alarm is triggered frequently, check whether the grid voltage is within the acceptable range. If not, contact the local power operator. If so, modify the power grid undervoltage protection threshold with the consent of the local power operator.</li> <li>3. If the fault persists for a long time, check the connection between the AC switch and the output power cable.</li> </ol>
5	1030	AC Overcurrent	Major	Shutdown, alarm reporting, and automatic recovery after the fault is rectified.	The grid voltage drops dramatically or the power grid or the output load is short-circuited. As a result, the Fox PowerQ transient output current exceeds the upper threshold and, which triggers the Fox PowerQ protection.	<ol style="list-style-type: none"> <li>1. The Fox PowerQ monitors its external working conditions in real time. And it can automatically recover after the fault is rectified.</li> <li>2. If the alarm is triggered frequently and affects the power production of the PV plant, check whether grid or the output is short-circuited. If the fault persists, contact your installer.</li> </ol>
6	1031	Grid Overfrequency	Major	Shutdown, alarm reporting, and automatic recovery after the fault is rectified.	The actual grid frequency is higher than the local power grid standard.	<ol style="list-style-type: none"> <li>1. If the alarm is triggered accidentally, it may be due to temporary abnormalities in the power grid. The Fox PowerQ will automatically recover after the power grid has resumed normal functioning.</li> <li>2. If the alarm is triggered frequently, check whether the grid frequency is within the acceptable range. If not, contact the local power operator. If so, modify the grid overfrequency protection threshold with the consent of the local power operator.</li> </ol>

Item	Alarm Number	Alarm Name	Alarm Severity	Alarm Action	Possible Cause	Suggestion
7	1032	Grid Underfrequency	Major	Shutdown, alarm reporting, and automatic recovery after the fault is rectified.	The actual grid frequency is below than lower threshold standard.	<ol style="list-style-type: none"> <li>1. If the alarm is triggered accidentally, it may be due to temporary abnormalities in the power grid. The Fox PowerQ will automatically recover after the power grid has resumed normal functioning.</li> <li>2. If the alarm is triggered frequently, check whether the grid frequency is within the acceptable range. If not, contact the local power operator. If so, modify the grid underfrequency protection threshold with the consent of the local power operator.</li> </ol>
8	1035	High Leakage Current Fault	Major	Shutdown, alarm reporting, and automatic recovery after the fault is rectified.	The leak current RMS value exceeds the threshold specified for leak current, and the temporary dynamic value exceeds 30mA over 0.3s, or exceeds 60mA 0.15s or 150mA 0.04s.	<ol style="list-style-type: none"> <li>1. If the alarm is triggered accidentally, it may be due to leak current exceeding the threshold or temporary dynamic value exceeding the threshold. The Fox PowerQ will automatically recover when the leak current is less than 100mA.</li> <li>2. If the alarm is triggered frequently and affects the power production of the PV plant, check ground impedance of PV. If the fault persists, contact your installer.</li> </ol>
9	1038	Grid Voltage High	Major	Shutdown, alarm reporting, and automatic recovery after the fault is rectified.	The grid voltage RMS value exceeds the higher threshold specified for HVRT.	<ol style="list-style-type: none"> <li>1. If the alarm is triggered accidentally, it may be due to temporary abnormalities in the power grid. The Fox PowerQ will automatically recover after the power grid has resumed normal functioning.</li> <li>2. Check whether the grid connection voltage exceeds the upper threshold. If so, contact the local power operator.</li> <li>3. If you have confirmed that the grid connection voltage exceeds the upper threshold and have obtained the consent of the local power operator, modify the overvoltage protection threshold.</li> </ol>

Item	Alarm Number	Alarm Name	Alarm Severity	Alarm Action	Possible Cause	Suggestion
10	1039	Hardware (L1) Inverter Overcurrent Fault	Major	Shutdown, alarm reporting, and automatic recovery after the fault is rectified.	The grid voltage drops dramatically or the power grid or the output load is short-circuited. As a result, the Fox PowerQ transient output current exceeds the upper threshold and, which triggers the Fox PowerQ protection.	<ol style="list-style-type: none"> <li>1. The Fox PowerQ monitors its external working conditions in real time. And it can automatically recover after the fault is rectified.</li> <li>2. If the alarm is triggered frequently and affects the power production of the PV plant, check whether grid or the output is overloaded or short-circuited. If the fault persists, contact your installer.</li> </ol>
11	1040	Unbalanced Grid Voltage	Major	Shutdown, alarm reporting, and automatic recovery after the fault is rectified.	The difference between grid phase voltages exceeds the upper threshold.	<ol style="list-style-type: none"> <li>1. Check that the grid voltage is within the normal range.</li> <li>2. Check the connection of the AC output power cable.</li> <li>3. If the cable is connected properly but the alarm is triggered frequently and affects the power production of the PV plant, contact the local power operator.</li> </ol>
12	1041	Hardware (L2) Inverter Overcurrent Fault	Major	Shutdown, alarm reporting, and automatic recovery after the fault is rectified.	The grid voltage drops dramatically or the power grid or the output load is short-circuited. As a result, the Fox PowerQ transient output current exceeds the upper threshold and, which triggers the Fox PowerQ protection.	<ol style="list-style-type: none"> <li>1. The Fox PowerQ monitors its external working conditions in real time. And it can automatically recover after the fault is rectified.</li> <li>2. If the alarm is triggered frequently and affects the power production of the PV plant, check whether grid or the output is overloaded or short-circuited. If the fault persists, contact your installer.</li> </ol>

Item	Alarm Number	Alarm Name	Alarm Severity	Alarm Action	Possible Cause	Suggestion
13	1042	Grid Frequency High	Major	Shutdown, alarm reporting, and automatic recovery after the fault is rectified.	The actual grid frequency is higher than the local power grid standard.	<ol style="list-style-type: none"> <li>1. If the alarm is triggered accidentally, it may be due to temporary abnormalities in the power grid. The Fox PowerQ will automatically recover after the power grid has resumed normal functioning.</li> <li>2. If the alarm is triggered frequently, check whether the grid frequency is within the acceptable range. If not, contact the local power operator. If so, modify the grid overfrequency protection threshold with the consent of the local power operator.</li> </ol>
14	1043	Grid Frequency Low	Major	Shutdown, alarm reporting, and automatic recovery after the fault is rectified.	The actual grid frequency is below than the local power grid standard.	<ol style="list-style-type: none"> <li>1. If the alarm is triggered accidentally, it may be due to temporary abnormalities in the power grid. The Fox PowerQ will automatically recover after the power grid has resumed normal functioning.</li> <li>2. If the alarm is triggered frequently, check whether the grid frequency is within the acceptable range. If not, contact the local power operator. If so, modify the grid underfrequency protection threshold with the consent of the local power operator.</li> </ol>
15	1047	Ground Wire Detection Fault	Major	Shutdown, alarm reporting, and automatic recovery after the fault is rectified.	<ol style="list-style-type: none"> <li>1. The PE cable for the Fox PowerQ is not connected.</li> <li>2. The voltage between the Fox PowerQ neutral wire and ground exceeds the upper threshold.</li> </ol>	<ol style="list-style-type: none"> <li>1. Check whether the PE cable for the Fox PowerQ is connected properly.</li> <li>2. Check whether the output is connected to an isolation transformer. If so, set OFF due to abnormal grounding to Disable.</li> <li>2. If the Fox PowerQ is connected to the TN power grid, check whether the voltage of the neutral wire to ground is normal.</li> </ol>
16	1057	Bus Transient Overvoltage	Major	Shutdown, alarm reporting, and automatic recovery after the fault is rectified.	Bus voltage is higher than the value of protection.	<ol style="list-style-type: none"> <li>1. If the alarm is triggered accidentally, it may be due to temporary abnormalities in the power grid. The Fox PowerQ will automatically recover after the power grid resumes normal functioning.</li> <li>2. Check the PV open voltage if higher than 550V.</li> <li>3. Check the BAT voltage if higher than 460V.</li> </ol>

Item	Alarm Number	Alarm Name	Alarm Severity	Alarm Action	Possible Cause	Suggestion
						4. If the fault persists, contact your installer.
17	1066	DC Input PV1 Reverse Connection Fault	Major	Shutdown, alarm reporting, and automatic recovery after the fault is rectified.	The PV1 module output is reversely connected.	Check whether the PV1 module output is reversely connected.
18	1067	DC Input PV2 Reverse Connection Fault	Major	Shutdown, alarm reporting, and automatic recovery after the fault is rectified.	The PV2 module output is reversely connected.	Check whether the PV2 module output is reversely connected.
19	1081	DC Input PV3 Reverse Connection Fault	Major	Shutdown, alarm reporting, and automatic recovery after the fault is rectified.	The PV3 module output is reversely connected.	Check whether the PV3 module output is reversely connected.
20	1089	INV IGBT Overtemperature	Major	Shutdown, alarm reporting, and automatic recovery after the fault is rectified.	The temperature of INV IGBT is higher than the threshold. 1. The Fox PowerQ is installed in a place with poor ventilation. 2. The ambient temperature exceeds the upper threshold. 3. The Fox PowerQ is not working properly.	1. Check the ventilation and ambient temperature at the Fox PowerQ installation position. 2. If the ventilation is poor or the ambient temperature exceeds the upper threshold, improve the ventilation and heat dissipation. 3. If the ventilation and ambient temperature both meet requirements, contact your installer.
21	1095	E-STOP Trigger	Major	Shutdown, alarm reporting, and automatic recovery after the fault is rectified.	Emergency Stop Switch triggered.	1. Check the Emergency Stop Switch if it is pushed. 2. Check the Emergency Stop Switch cable if the Emergency Stop Switch is open. 3. Check whether the Emergency Stop Switch cable is connected to the correct connector of the Fox PowerQ. 4. If the fault persists, contact your installer.

Item	Alarm Number	Alarm Name	Alarm Severity	Alarm Action	Possible Cause	Suggestion
22	1109	Leak Current CT Self-checking Fault	Major	Shutdown, alarm reporting, and automatic recovery after the fault is rectified.	Residual Current CT check failure. The insulation impedance of the input side to PE decreased.	<ol style="list-style-type: none"> <li>1. If it is triggered accidentally, the external power cable may be abnormal temporarily. The Fox PowerQ automatically recovers after the fault is rectified.</li> <li>2. If the alarm is triggered frequently or persists, check that the impedance between the PV string and ground is not below the lower threshold.</li> </ol>
23	1122	Ambient Overtemperature	Major	Shutdown, alarm reporting, and automatic recovery after the fault is rectified.	<p>The inner temperature of Fox PowerQ is higher than the upper threshold .</p> <ol style="list-style-type: none"> <li>1. The Fox PowerQ is installed in a place with poor ventilation.</li> <li>2. The ambient temperature exceeds the upper threshold.</li> <li>3. The Fox PowerQ is not working properly.</li> </ol>	<ol style="list-style-type: none"> <li>1. Check the ventilation and ambient temperature at the Fox PowerQ installation position.</li> <li>2. If the ventilation is poor or the ambient temperature exceeds the upper threshold, improve the ventilation and heat dissipation.</li> <li>3. If the ventilation and ambient temperature both meet requirements, contact your installer.</li> </ol>
24	1124	Low Insulation Impedance Fault	Major	Shutdown, alarm reporting, and automatic recovery after the fault is rectified.	<p>Low Insulation Resistance is below than the value of protection.</p> <ol style="list-style-type: none"> <li>1. The PV string is shorted to PE.</li> <li>2. The PV string has been operating in a moist environment for a long time.</li> </ol>	<ol style="list-style-type: none"> <li>1. Check the impedance between the PV array output and PE, and eliminate short circuits and poor insulation points.</li> <li>2. Check whether the Fox PowerQ PE cable is properly connected.</li> <li>3. If you are sure that the impedance is less than the value of protection in a cloudy or rainy environment, reset insulation resistance protection.</li> </ol>
25	1126	Leak Current Sampling Channel Fault	Major	Shutdown, alarm reporting, and automatic recovery after the fault is rectified.	Residual Current CT check failure. The insulation impedance of the input side to PE decreased.	<ol style="list-style-type: none"> <li>1. If it is triggered accidentally, the external power cable may be abnormal temporarily. The Fox PowerQ automatically recovers after the fault is rectified.</li> <li>2. If the alarm is triggered frequently or persists, check that the impedance between the PV string and ground is not below the lower threshold.</li> </ol>
26	1136	Load Overpower Fault	Major	Shutdown, alarm reporting,	The power of the Off-Grid Load is	Check if the power of the Off-Grid Load exceeds the permitted value.

Item	Alarm Number	Alarm Name	Alarm Severity	Alarm Action	Possible Cause	Suggestion
				and automatic recovery after the fault is rectified.	higher than the upper threshold in the Off-Grid Mode.	
27	1137	INV Low Voltage Fault Under Off-grid	Major	Shutdown, alarm reporting, and automatic recovery after the fault is rectified.	The output voltage is below the lower threshold in the Off-Grid Mode.	<ol style="list-style-type: none"> <li>1. Check if the power of the Off-Grid Load exceeds the permitted value.</li> <li>2. Check if the output is shorted.</li> </ol>
28	1144	Arc Self-checking Fault	Major	Shutdown, alarm reporting, and automatic recovery after the fault is rectified.	The PV string power cable arcs or is in poor contact.	Check whether the string circuit arcs or is in poor contact. After the fault is rectified, manually clear the alarm and then start again.
29	1145	Arc Fault	Major	Shutdown, alarm reporting, and automatic recovery after the fault is rectified.	The sampling circuit of the AFCI circuit is not operating correctly.	Check whether the string circuit arcs or is in poor contact. After the fault is rectified, manually clear the alarm and then start again.
30	1154	INV Overcurrent Permanent Fault	Major	Shutdown, alarm reporting, and automatic recovery after the fault is rectified.	The grid voltage drops dramatically or the power grid or the output load is short-circuited. As a result, the Fox PowerQ transient output current exceeds the upper threshold and, which triggers the Fox PowerQ protection.	<ol style="list-style-type: none"> <li>1. The Fox PowerQ monitors its external working conditions in real time. And it can automatically recover after the fault is rectified.</li> <li>2. If the alarm is triggered frequently and affects the power production of the PV plant, check whether grid or the output is overloaded or short-circuited. If the fault persists, contact your installer.</li> </ol>



Item	Alarm Number	Alarm Name	Alarm Severity	Alarm Action	Possible Cause	Suggestion
31	1168	INVL2 Overcurrent Permanent Fault	Major	Shutdown, alarm reporting, and automatic recovery after the fault is rectified.	The grid voltage drops dramatically or the power grid or the output load is short-circuited. As a result, the Fox PowerQ transient output current exceeds the upper threshold and, which triggers the Fox PowerQ protection.	<ol style="list-style-type: none"> <li>1. The Fox PowerQ monitors its external working conditions in real time. And it can automatically recover after the fault is rectified.</li> <li>2. If the alarm is triggered frequently and affects the power production of the PV plant, check whether grid or the output is overloaded or short-circuited. If the fault persists, contact your installer.</li> </ol>
32	1172	Leak Current Permanent Fault	Major	Shutdown, alarm reporting, and automatic recovery after the fault is rectified.	The insulation impedance of the input side to PE decreases when the Fox PowerQ is operating	<ol style="list-style-type: none"> <li>1. If the alarm is triggered accidentally, the external power cable may be abnormal temporarily. The Fox PowerQ automatically recover after the fault is rectified.</li> <li>2. If the alarm is triggered frequently or persists, check that the impedance between the PV string and ground is not below the lower threshold.</li> </ol>
33	1217	Transient Overcurrent during BDC Charging	Major	Shutdown, alarm reporting, and automatic recovery after the fault is rectified.	The Battery DC charge current is higher than the upper threshold.  1. The battery is faulty.	<ol style="list-style-type: none"> <li>1. If the FAULT indicator on the front of the battery pack is ON or flashing, contact your installer.</li> <li>2. Check that the communications cable and power cable between the Fox PowerQ and the battery are properly connected.</li> <li>2. Send a shutdown command on the app. Turn off the AC output switch, DC input switch, and battery switch in order, and then turn on the battery switch, AC output switch, and DC input switch in sequence after 5 minutes.</li> <li>3. If the alarm still exists, contact your installer.</li> </ol>
34	1218	Transient Overcurrent during BDC Discharging	Major	Shutdown, alarm reporting, and automatic recovery after the fault is rectified.	The Battery DC discharge current is higher than the upper threshold.  1. The battery is faulty. 2. The battery SOC is	<ol style="list-style-type: none"> <li>1. If the FAULT indicator on the front of the battery pack is ON or flashing, contact your installer.</li> <li>2. Check that the communications cable and power cable between the Fox PowerQ and the battery are properly connected.</li> <li>3. Send a shutdown command on the app.</li> </ol>

Item	Alarm Number	Alarm Name	Alarm Severity	Alarm Action	Possible Cause	Suggestion
					too low.	Turn off the AC output switch, DC input switch, and battery switch in order, and then turn on the battery switch, AC output switch, and DC input switch in sequence after 5 minutes. 4. If the alarm still exists, contact your installer.
35	1229	BDC Overtemperature Fault	Major	Shutdown, alarm reporting, and automatic recovery after the fault is rectified.	The temperature of battery DC IGBT is higher than the upper threshold. 1. The Fox PowerQ is installed in a place with poor ventilation. 2. The ambient temperature exceeds the upper threshold. 3. The Fox PowerQ is not working properly.	1. Check the ventilation and ambient temperature at the Fox PowerQ installation position. 2. If the ventilation is poor or the ambient temperature exceeds the upper threshold, improve the ventilation and heat dissipation. 3. If the ventilation and ambient temperature both meet requirements, contact your installer.
36	1242	BDC Average Low Voltage Fault (Total battery voltage is below undervoltage value in non-charging mode)	Major	Shutdown, alarm reporting, and automatic recovery after the fault is rectified.	1. The battery is faulty.	1. If the FAULT indicator on the front of the battery pack is ON or flashing, contact your installer. 2. Check that the communications cable and power cable between the Fox PowerQ and the battery are properly connected. 2. Send a shutdown command on the app. Turn off the AC output switch, DC input switch, and battery switch in order, and then turn on the battery switch, AC output switch, and DC input switch in sequence after 5 minutes. 3. If the alarm still exists, contact your installer.
37	1247	Reversed Battery Polarity Connection Fault	Major	Shutdown, alarm reporting, and automatic recovery after the fault is rectified.	The battery output is reversely connected.	Check whether the battery output is reversely connected.

Item	Alarm Number	Alarm Name	Alarm Severity	Alarm Action	Possible Cause	Suggestion
38	1248	BDC Overload Fault	Major	Shutdown, alarm reporting, and automatic recovery after the fault is rectified.	<ol style="list-style-type: none"> <li>1. The battery is faulty.</li> <li>2. The battery SOC is too low.</li> </ol>	<ol style="list-style-type: none"> <li>1. Check that the communications cable and power cable between the Fox PowerQ and the battery are properly connected.</li> <li>2. Send a shutdown command on the app. Turn off the AC output switch, DC input switch, and battery switch in order, and then turn on the battery switch, AC output switch, and DC input switch in sequence after 5 minutes.</li> <li>3. If the alarm still exists, contact your installer.</li> </ol>
39	1281	Communication Fault between Communication Board and Main DSP	Minor	Alarm reporting	<ol style="list-style-type: none"> <li>1. The communication cables are not connected properly.</li> <li>2. The communication is interfered.</li> </ol>	<ol style="list-style-type: none"> <li>1. Turn off the AC output switch, DC input switch, and battery switch in order, and then turn on the battery switch, AC output switch, and DC input switch in sequence after 2 minutes.</li> <li>2. If the fault still exists, contact your installer.</li> </ol>
40	1283	Communication Fault between Communication Board and BMS	Minor	Alarm reporting	<ol style="list-style-type: none"> <li>1. The communication cables are not connected well.</li> <li>2. The communication cables are too long or do not use shielded twisted pair with drain wire.</li> </ol>	Shut down the battery and check the communication cables and power cable between the Fox PowerQ and the battery are properly connected.
41	1284	Communication Fault between Communication Board and Built-in Meter	Minor	Alarm reporting	The RS485 communication cables of the Built-in Meter are not properly connected.	<ol style="list-style-type: none"> <li>1. Turn off the AC output switch, DC input switch, and battery switch in order, and then turn on the battery switch, AC output switch, and DC input switch in sequence after 2 minutes.</li> <li>2. If the fault still exists, contact your installer.</li> </ol>
42	1285	Communication Fault between Communication Board and Grid Meter	Minor	Alarm reporting	The RS485 communication cables of the Grid Meter are not properly connected.	Check that the communications cable and power cable between the Fox PowerQ and the Meter are properly connected.

Item	Alarm Number	Alarm Name	Alarm Severity	Alarm Action	Possible Cause	Suggestion
43	1286	Communication Board Flash Writing Fault	Minor	Alarm reporting	<ol style="list-style-type: none"> <li>1. The Flash IC is interfered.</li> <li>2. Flash IC fails.</li> </ol>	<ol style="list-style-type: none"> <li>1. Turn off the AC output switch, DC input switch, and battery switch in order, and then turn on the battery switch, AC output switch, and DC input switch in sequence after 2 minutes.</li> <li>2. If the fault still exists, contact your installer.</li> </ol>
44	1287	RTC Read-Write Fault	Minor	Alarm reporting	The RTC communication is interfered.	<ol style="list-style-type: none"> <li>1. Turn off the AC output switch, DC input switch, and battery switch in order, and then turn on the battery switch, AC output switch, and DC input switch in sequence after 2 minutes.</li> <li>2. If the fault still exists, contact your installer.</li> </ol>
45	1288	Communication Fault between Communication Board and HUB Board	Minor	Shutdown, alarm reporting, and automatic recovery after the fault is rectified.	<ol style="list-style-type: none"> <li>1. The RS485 communication cables are not properly connected.</li> <li>2. The RS485 communication cables are too long or do not use shielded twisted pair with drain wire.</li> </ol>	<ol style="list-style-type: none"> <li>1. Check whether the RS485 communication cable between Fox PowerQ and FOX Hub G2, also between Fox PowerQ units, are properly connected.</li> <li>2. Check whether the length of the communication cable exceeds the upper threshold in the specification, and whether it is shielded twisted pair with drain wire.</li> <li>3. Turn off the AC output switch, DC input switch, and battery switch in order, and then turn on the battery switch, AC output switch, and DC input switch in sequence after 2 minutes.</li> <li>4. If the fault still exists, contact your installer.</li> </ol>
46	1289	Solar Meter Communication Fault	Minor	Alarm reporting	The RS485 communication cables of the Solar Meter are not properly connected.	Check the RS485 communication cables of the Solar Meter are properly connected.
47	1290	GEN Meter Communication Fault	Minor	Alarm reporting	The RS485 communication cables of the GEN Meter are not properly connected.	Check whether the RS485 communication cables of the GEN Meter are properly connected.

**Note!**

If the installer issued a remote shutdown command (key off) in a certain situation while the system was working in an off-grid mode, this will result in a power outage and loss of WiFi connection at the user's home. The installer is unable to restore the system remotely. In this case, the installer needs to contact the user to manually restore the system following these steps: press the E-STOP button and wait for 3 seconds; then rotate the button clockwise to release it. If the E-STOP button is released too late, it may cause a complete power loss of the Fox PowerQ's auxiliary power supply. In such cases, a black start is required to power on the system (detailed instructions can be found in the Installation Guide).

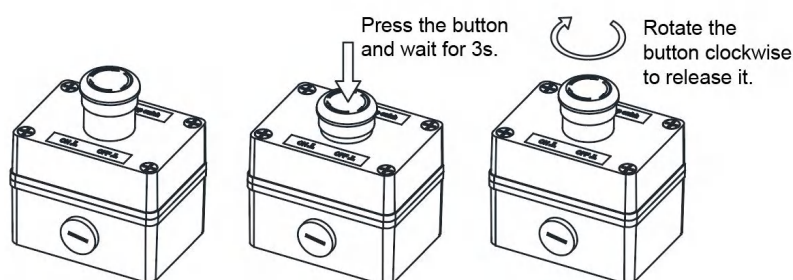

## 5.2 Service and Maintenance

### • Service

- Keep the Fox PowerQ clear of any leaves or foreign objects, particularly avoiding their presence on top of the unit or between the unit and the back wall.
- Keep the Fox PowerQ away from the direct sunlight.
- Keep all the equipment in an environment with acceptable temperature and humidity.
- Clean the equipment surface using a soft cloth. If necessary, lightly dampen the cloth with water (only) and ensure that the equipment is fully powered off before cleaning.
- Do not block the vents.
- Maintain a safe distance between all units and substances that are flammable, explosive, or toxic.
- Keep the equipment operating within the allowed power range and avoid overloading.
- Verify that all cables are securely connected and all connectors are free from stress.
- Maintain a safe distance between the equipment and hazardous areas or potential risks.

### • Maintenance

- Please check the running status of your equipment on your mobile app. If any alarm is found, please contact the qualified service group.
- Do not attempt to repair the system by yourself. Contact the professionals qualified by Fox ESS.
- If the problem cannot be solved via the above solution, contact Fox ESS customer service for further assistance. Please be prepared to describe details of your system installation and provide the model and serial number of the unit.

## **6 Decommissioning**

### **6.1 Dismantling the Fox PowerQ energy storage system**

- Turn off the PV/DC switch, battery, AC breakers, and off-grid breaker of the FOX Hub G2. Wait for 5 minutes for the Fox PowerQ and the FOX Hub G2 to fully de-energize.
- Disconnect communication and optional connection wirings. Remove the Fox PowerQ and the FOX Hub G2 from the bracket.
- Remove the bracket if necessary.

### **6.2 Packaging**

If possible, please pack the Fox PowerQ and the FOX Hub G2 with the original packaging. If it is no longer available, you can also use an equivalent box that meets the following requirements.

- Suitable for loads more than 38 kg.
- Contains a handle.
- Can be fully closed.

### **6.3 Storage and Transportation**

Store the Fox PowerQ and the FOX Hub G2 in dry place where ambient temperatures are always between -40 °C-+70 °C. Take care of the Fox PowerQ and the FOX Hub G2 during the storage and transportation; keep less than 4 cartons in one stack. When the Fox PowerQ or other related components need to be disposed of, please ensure it is carried out according to local waste handling regulations. Please be sure to deliver the Fox PowerQ and the FOX Hub G2 that need to be disposed from sites that are appropriate for the disposal in accordance with local regulations.

# 7 Appendix 1: Fox ESS Three-line Diagram (1 FOX Hub G2+1 Fox PowerQ Unit)

## Whole-home Backup (DC Couple)

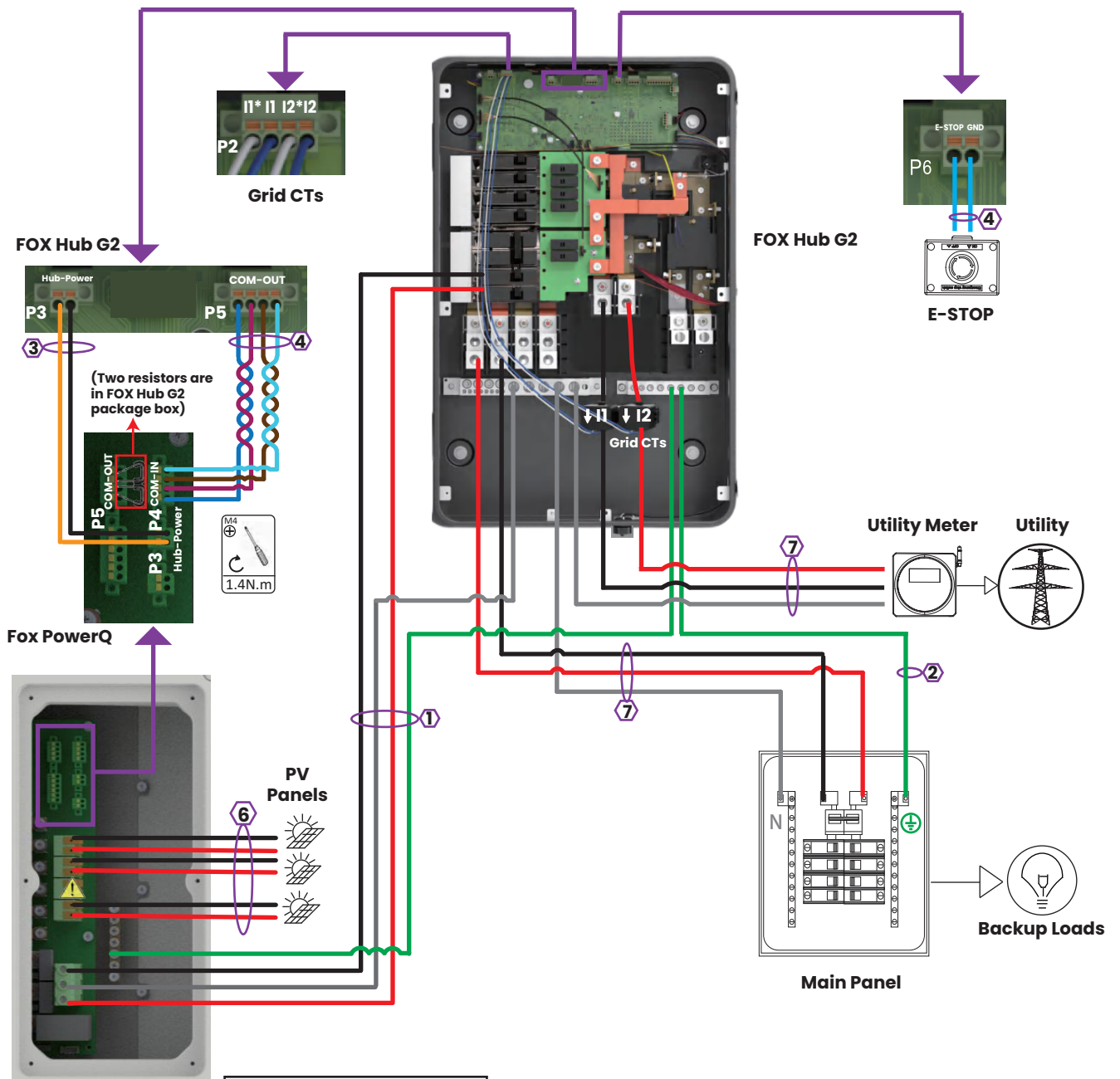

**Note**

- \* If there are  $\leq 3$  PV strings, 3 PV strings are preferentially connected to terminals 1A+, 1A-, 2+, 2-, 3+, 3-.
- \* If there are 4 PV strings, the number of PV panels connected to terminals 1A+, 1A- need to be the same as that connected to terminals 1B+, 1B-.

**Key**

- L1/Negative
- L2/Positive
- Ground
- Neutral
- Other Colors: Sensors/Communications

Wire Gauge Guide(copper)		
Label	Input Terminal	Conductor
1	BAT/AC IN/OUT/N/GND	6 AWG
2	AC IN/OUT/N/GND	6-2/0 AWG
3	Power	16 AWG
4	Signal Cable	24-16 AWG
5	Communication Cable	Ethernet Cable
6	MPPT	10 AWG
7	AC IN/OUT/N	6AWG-250 kcmil
8	AC IN/OUT/N	6-4/0 AWG
9	AC IN/OUT	6-1/0 AWG

# Fox ESS Three-line Diagram (1 FOX Hub G2+1 Fox PowerQ Unit)

## Whole-home Backup (AC Couple)

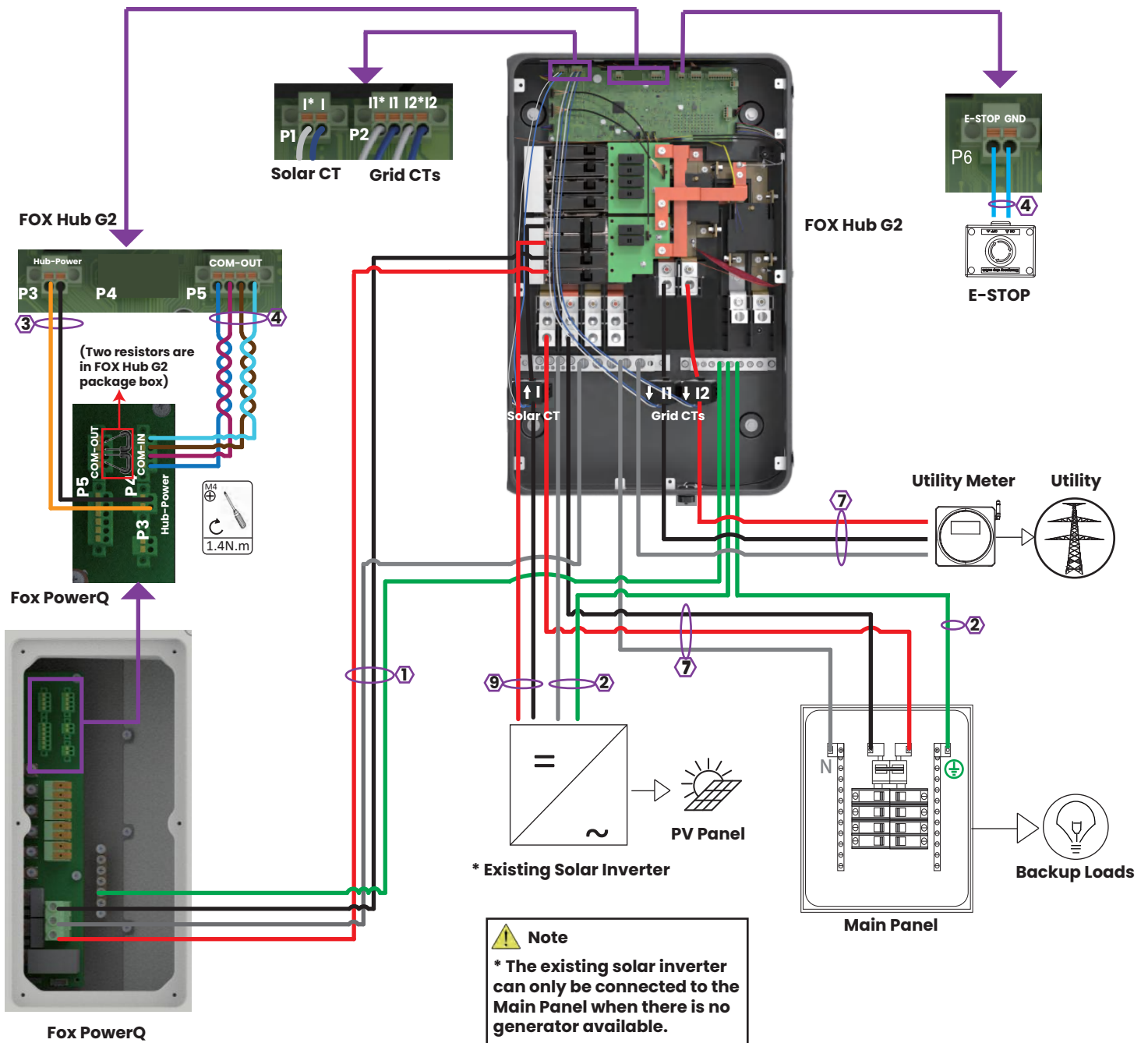

Key		
●	L1/Negative	
●	L2/Positive	
●	Ground	
●	Neutral	
●	Other Colors: Sensors/Communications	

Wire Gauge Guide(copper)		
Label	Input Terminal	Conductor
1	BAT/AC IN/OUT/N/GND	6 AWG
2	AC IN/OUT/N/GND	6-2/0 AWG
3	Power	16 AWG
4	Signal Cable	24-16 AWG
5	Communication Cable	Ethernet Cable
6	MPPT	10 AWG
7	AC IN/OUT/N	6AWG-250 kcmil
8	AC IN/OUT/N	6-4/0 AWG
9	AC IN/OUT	6-1/0 AWG



# Fox ESS Three-line Diagram (1 FOX Hub G2+1 Fox PowerQ Unit)

## Partial-home Backup (DC Couple) (FOX Hub G2 as Service Panel)

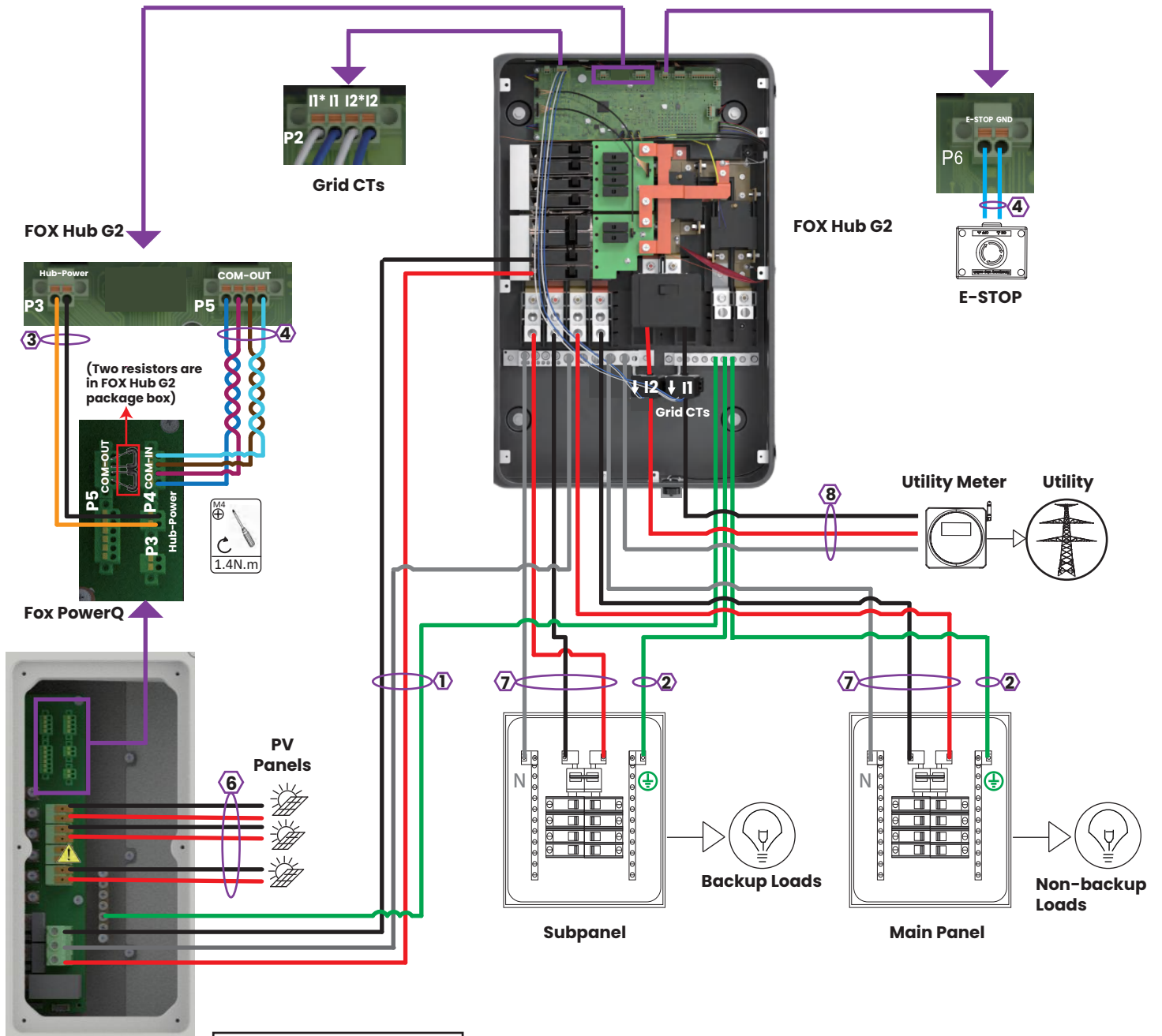

**Note**

- \* If there are  $\leq 3$  PV strings, 3 PV strings are preferentially connected to terminals 1A+, 1A-, 2+, 2-, 3+, 3-.
- \* If there are 4 PV strings, the number of PV panels connected to terminals 1A+, 1A- need to be the same as that connected to terminals 1B+, 1B-.

**Key**

- L1/Negative
- L2/Positive
- Ground
- Neutral
- Other Colors: Sensors/Communications

Wire Gauge Guide(copper)		
Label	Input Terminal	Conductor
1	BAT/AC IN/OUT/N/GND	6 AWG
2	AC IN/OUT/N/GND	6-2/0 AWG
3	Power	16 AWG
4	Signal Cable	24-16 AWG
5	Communication Cable	Ethernet Cable
6	MPPT	10 AWG
7	AC IN/OUT/N	6AWG-250 kcmil
8	AC IN/OUT/N	6-4/0 AWG
9	AC IN/OUT	6-1/0 AWG

# Fox ESS Three-line Diagram (1 FOX Hub G2+1 Fox PowerQ Unit)

## Partial-home Backup (DC Couple) (FOX Hub G2 not as Service Panel)

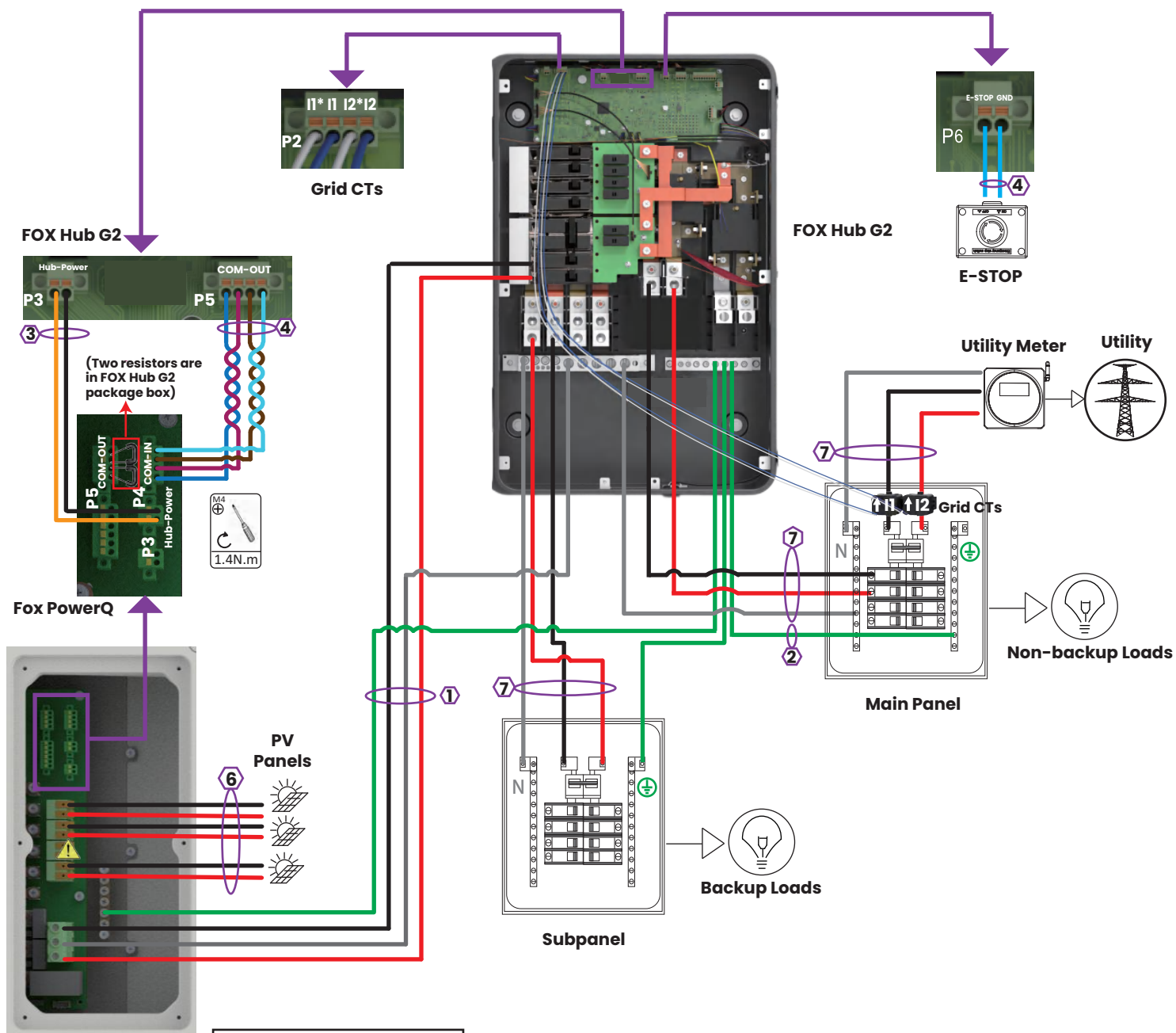

**Note**

- \* If there are  $\leq 3$  PV strings, 3 PV strings are preferentially connected to terminals 1A+, 1A-, 2+, 2-, 3+, 3-.
- \* If there are 4 PV strings, the number of PV panels connected to terminals 1A+, 1A- need to be the same as that connected to terminals 1B+, 1B-.

**Key**

- L1/Negative
- L2/Positive
- Ground
- Neutral

Other Colors: Sensors/Communications

Wire Gauge Guide(copper)		
Label	Input Terminal	Conductor
1	BAT/AC IN/OUT/N/GND	6 AWG
2	AC IN/OUT/N/GND	6-2/0 AWG
3	Power	16 AWG
4	Signal Cable	24-16 AWG
5	Communication Cable	Ethernet Cable
6	MPPT	10 AWG
7	AC IN/OUT/N	6AWG-250 kcmil
8	AC IN/OUT/N	6-4/0 AWG
9	AC IN/OUT	6-1/0 AWG

# Fox ESS Three-line Diagram (1 FOX Hub G2+1 Fox PowerQ Unit)

## Partial-home Backup (AC Couple) (FOX Hub G2 as Service Panel)

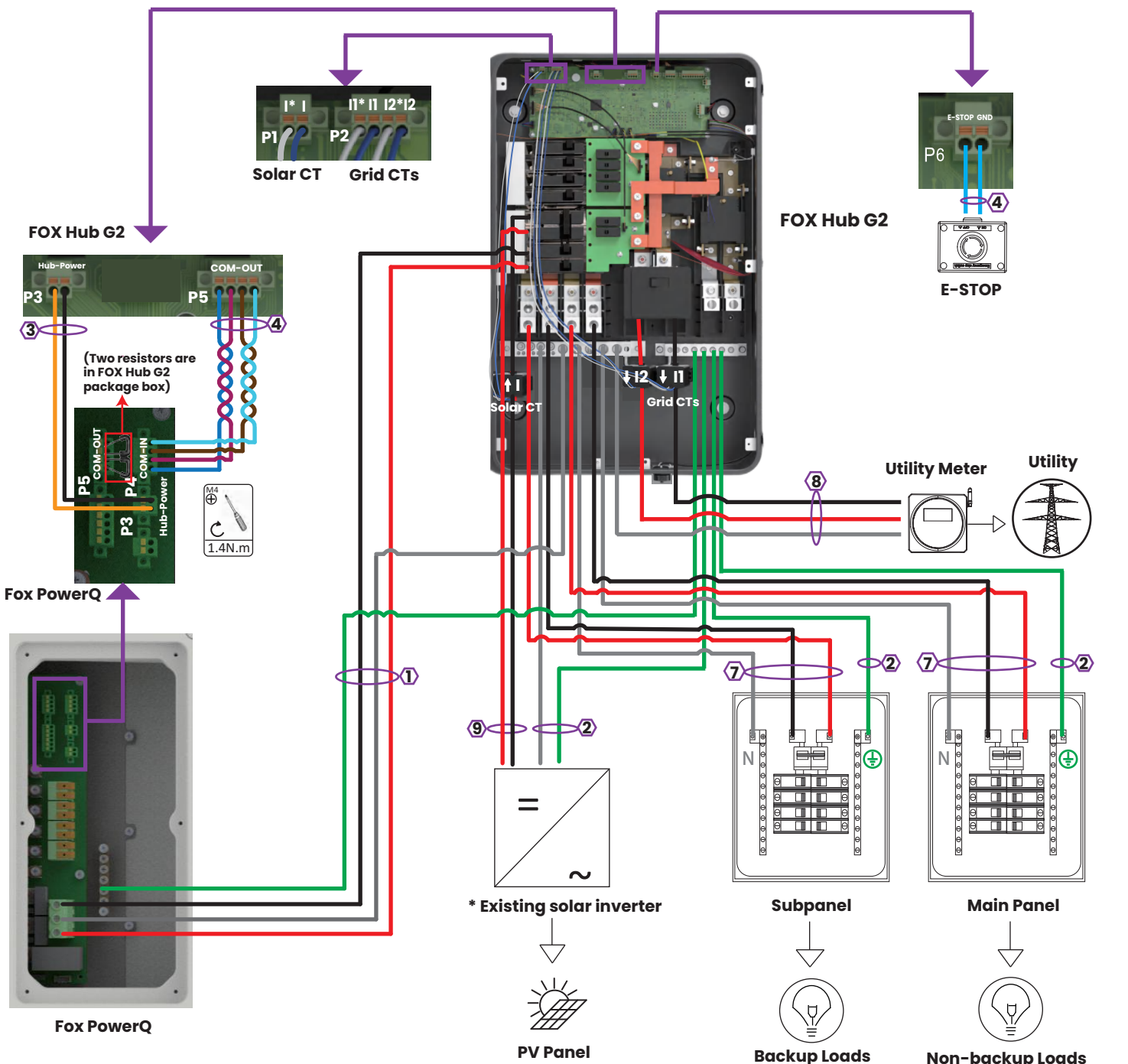

**⚠ Note**  
 \* The existing solar inverter can only be connected to the Main Panel when there is no generator available.

**Key**

- L1/Negative
- L2/Positive
- Ground
- Neutral

Other Colors: Sensors/Communications

Wire Gauge Guide(copper)		
Label	Input Terminal	Conductor
1	BAT/AC IN/OUT/N/GND	6 AWG
2	AC IN/OUT/N/GND	6-2/0 AWG
3	Power	16 AWG
4	Signal Cable	24-16 AWG
5	Communication Cable	Ethernet Cable
6	MPPT	10 AWG
7	AC IN/OUT/N	6AWG-250 kcmil
8	AC IN/OUT/N	6-4/0 AWG
9	AC IN/OUT	6-1/0 AWG

# Fox ESS Three-line Diagram (1 FOX Hub G2+1 Fox PowerQ Unit)

Partial-home Backup (AC Couple) (FOX Hub G2 not as Service Panel)

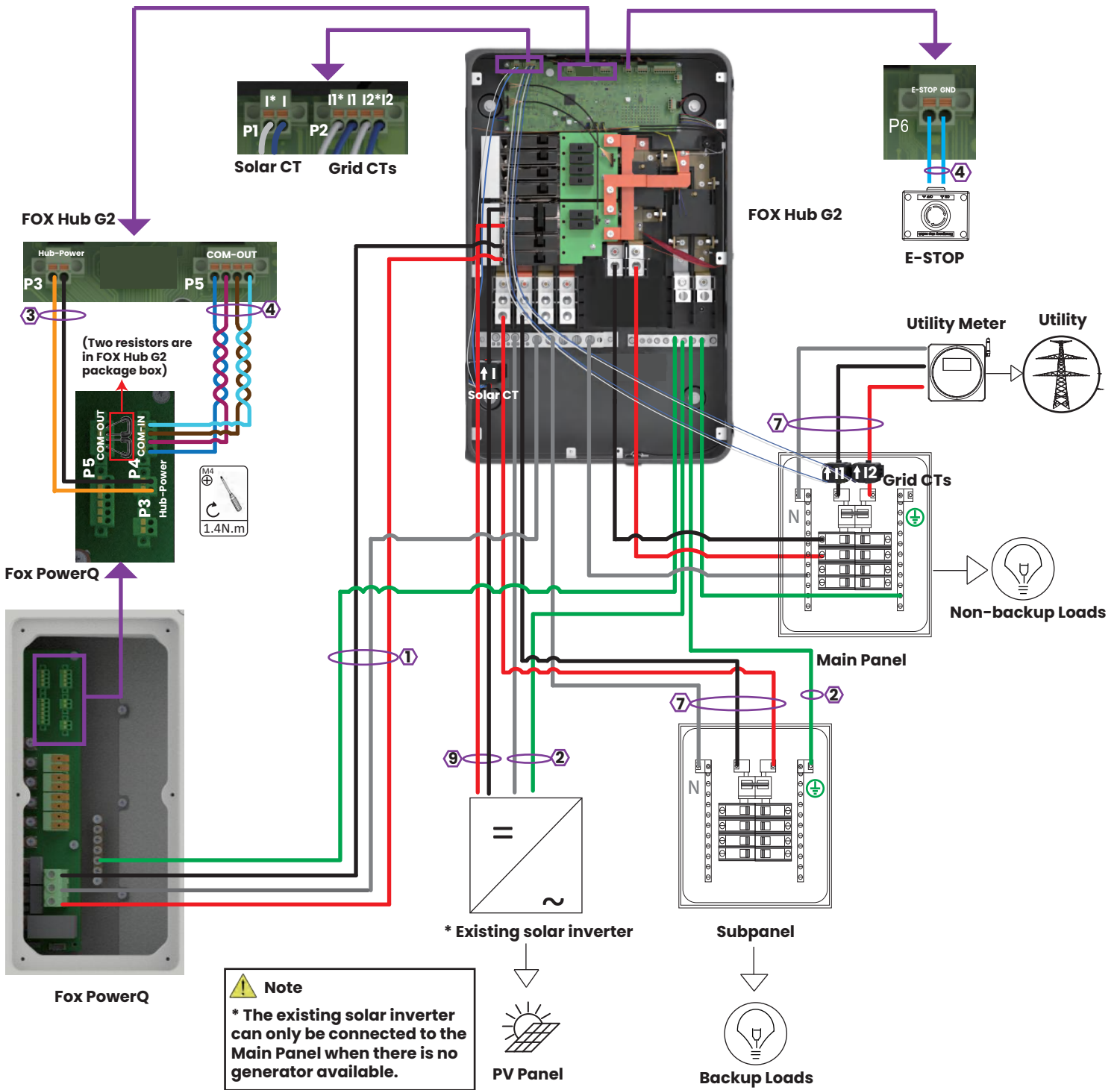

Wire Gauge Guide(copper)		
Label	Input Terminal	Conductor
1	BAT/AC IN/OUT/N/GND	6 AWG
2	AC IN/OUT/N/GND	6-2/0 AWG
3	Power	16 AWG
4	Signal Cable	24-16 AWG
5	Communication Cable	Ethernet Cable
6	MPPT	10 AWG
7	AC IN/OUT/N	6AWG-250 kcmil
8	AC IN/OUT/N	6-4/0 AWG
9	AC IN/OUT	6-1/0 AWG

# Fox ESS Three-line Diagram (1 FOX Hub G2+1 Fox PowerQ Unit)

## Generator Wiring

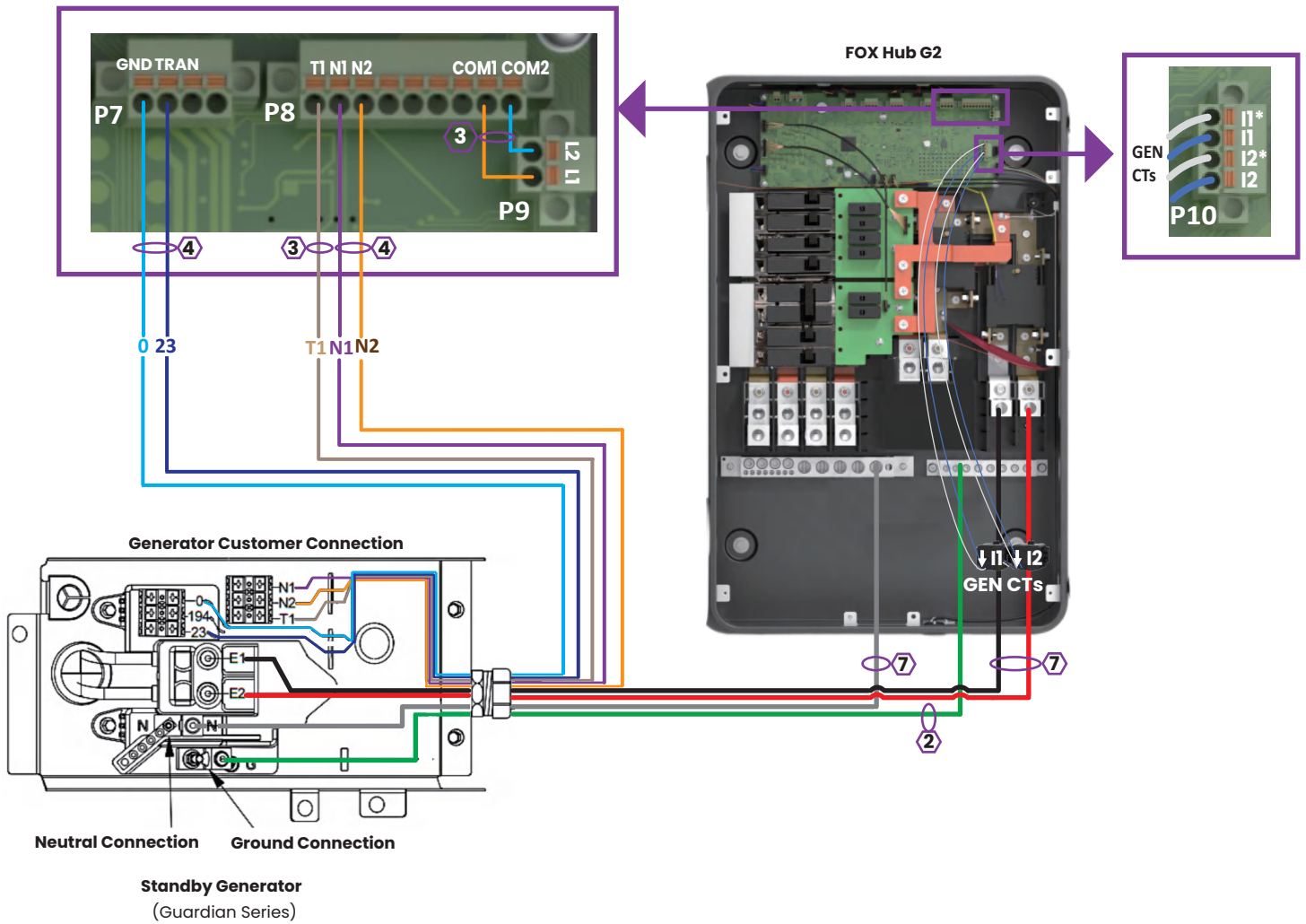

Wire Gauge Guide(copper)		
Label	Input Terminal	Conductor
1	BAT/AC IN/OUT/N/GND	6 AWG
2	AC IN/OUT/N/GND	6-2/0 AWG
3	Power	16 AWG
4	Signal Cable	24-16 AWG
5	Communication Cable	Ethernet Cable
6	MPPT	10 AWG
7	AC IN/OUT/N	6AWG-250 kcmil
8	AC IN/OUT/N	6-4/0 AWG
9	AC IN/OUT	6-1/0 AWG

**Key**

- L1/Negative
- L2/Positive
- Ground
- Neutral

Other Colors: Sensors/Communications



# Fox ESS Three-line Diagram (1 FOX Hub G2+1 Fox PowerQ Unit)

## Smart Loads Wiring

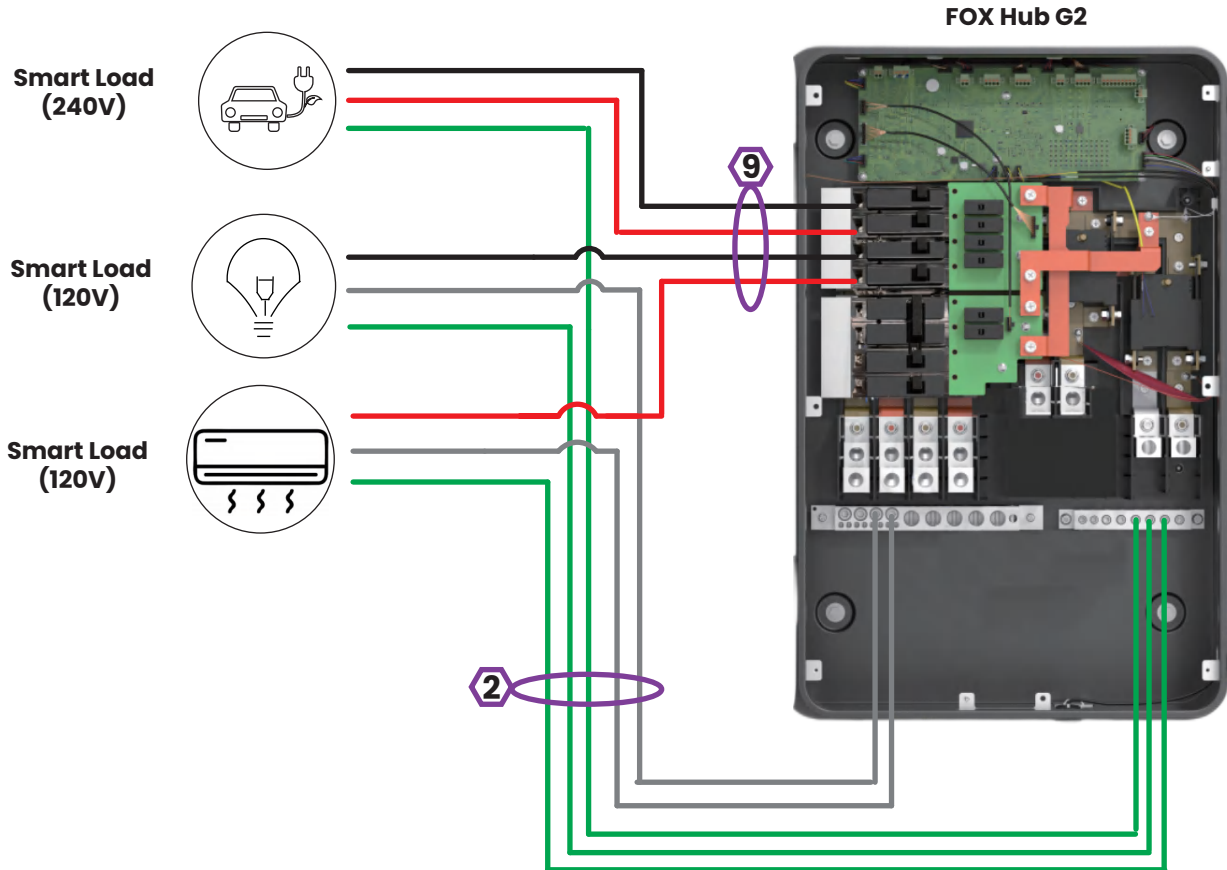

Key	
●	L1/Negative
●	L2/Positive
●	Ground
●	Neutral
Other Colors: Sensors/Communications	

Wire Gauge Guide(copper)		
Label	Input Terminal	Conductor
1	BAT/AC IN/OUT/N/GND	6 AWG
2	AC IN/OUT/N/GND	6-2/0 AWG
3	Power	16 AWG
4	Signal Cable	24-16 AWG
5	Communication Cable	Ethernet Cable
6	MPPT	10 AWG
7	AC IN/OUT/N	6AWG-250 kcmil
8	AC IN/OUT/N	6-4/0 AWG
9	AC IN/OUT	6-1/0 AWG

# 8 Appendix 2: Fox ESS Three-line Diagram (1 FOX Hub G2+Parallel Fox PowerQ Units)

## Whole-home Backup (DC Couple)

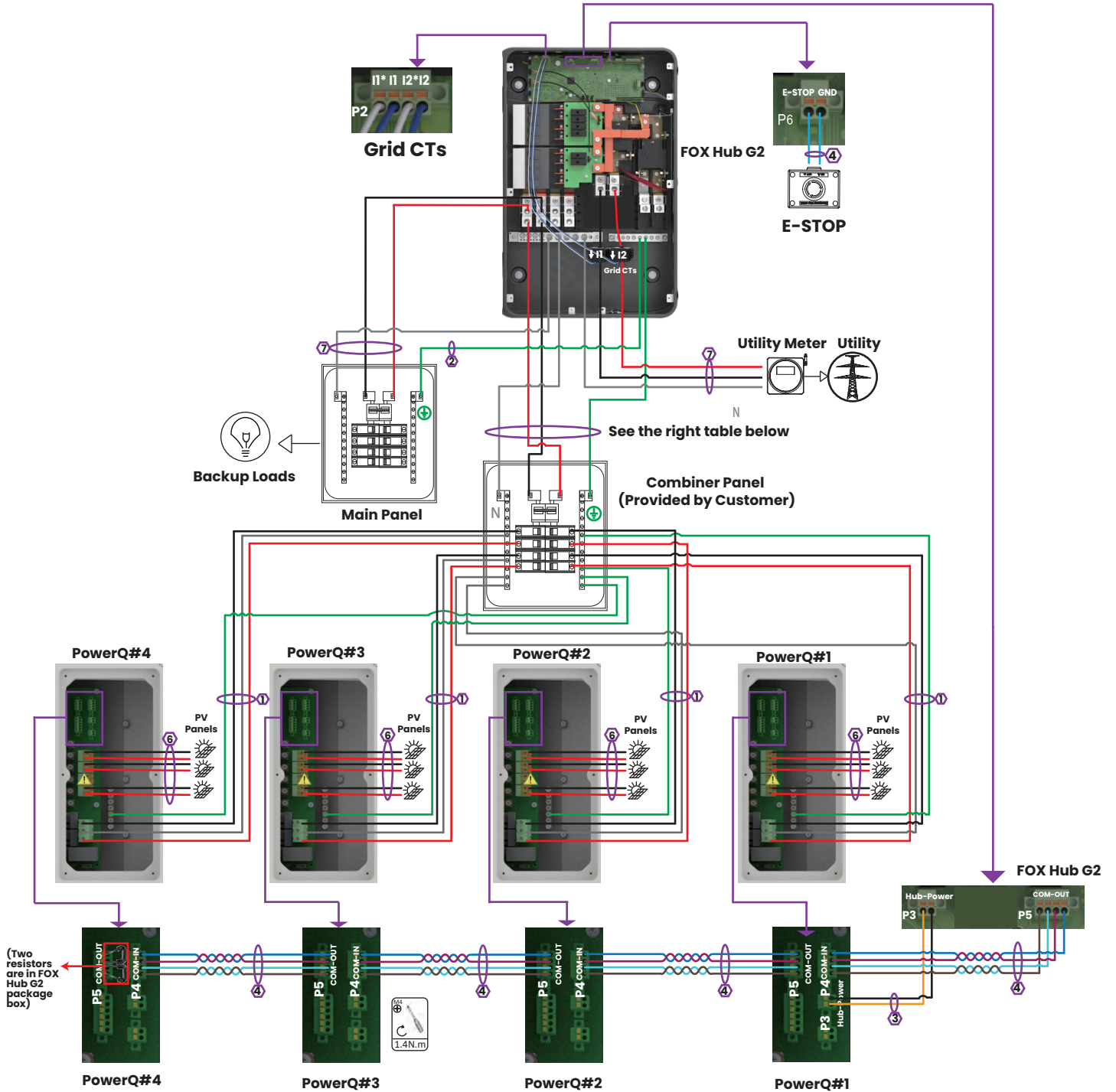

(Two resistors are in FOX Hub G2 package box)

Key	
●	L1/Negative
●	L2/Positive
●	Ground
●	Neutral
●	Other Colors: Sensors/Communications

Wire Gauge Guide(copper)		
Label	Input Terminal	Conductor
1	BAT/AC IN/OUT/N/GND	6 AWG
2	AC IN/OUT/N/GND	6-2/0 AWG
3	Power	16 AWG
4	Signal Cable	24-16 AWG
5	Communication Cable	Ethernet Cable
6	MPPT	10 AWG
7	AC IN/OUT/N	6AWG-250 kcmil
8	AC IN/OUT/N	6-4/0 AWG
9	AC IN/OUT	6-1/0 AWG

**Note**

- \* If there are ≤ 3 PV strings, 3 PV strings are preferentially connected to terminals 1A+, 1A-, 2+, 2-, 3+, 3-.
- \* If there are 4 PV strings, the number of PV panels connected to terminals 1A+, 1A- need to be the same as that connected to terminals 1B+, 1B-.

No. of Parellel AIOs	Minimum Wire Gauge (Cominer Panel-FOX Hub G2)
2 Inverters	2 AWG
3 Inverters	2/0 AWG
4 Inverters	4/0 AWG

# Fox ESS Three-line Diagram (1 FOX Hub G2+Parallel Fox PowerQ Units)

## Whole-home Backup (AC Couple)

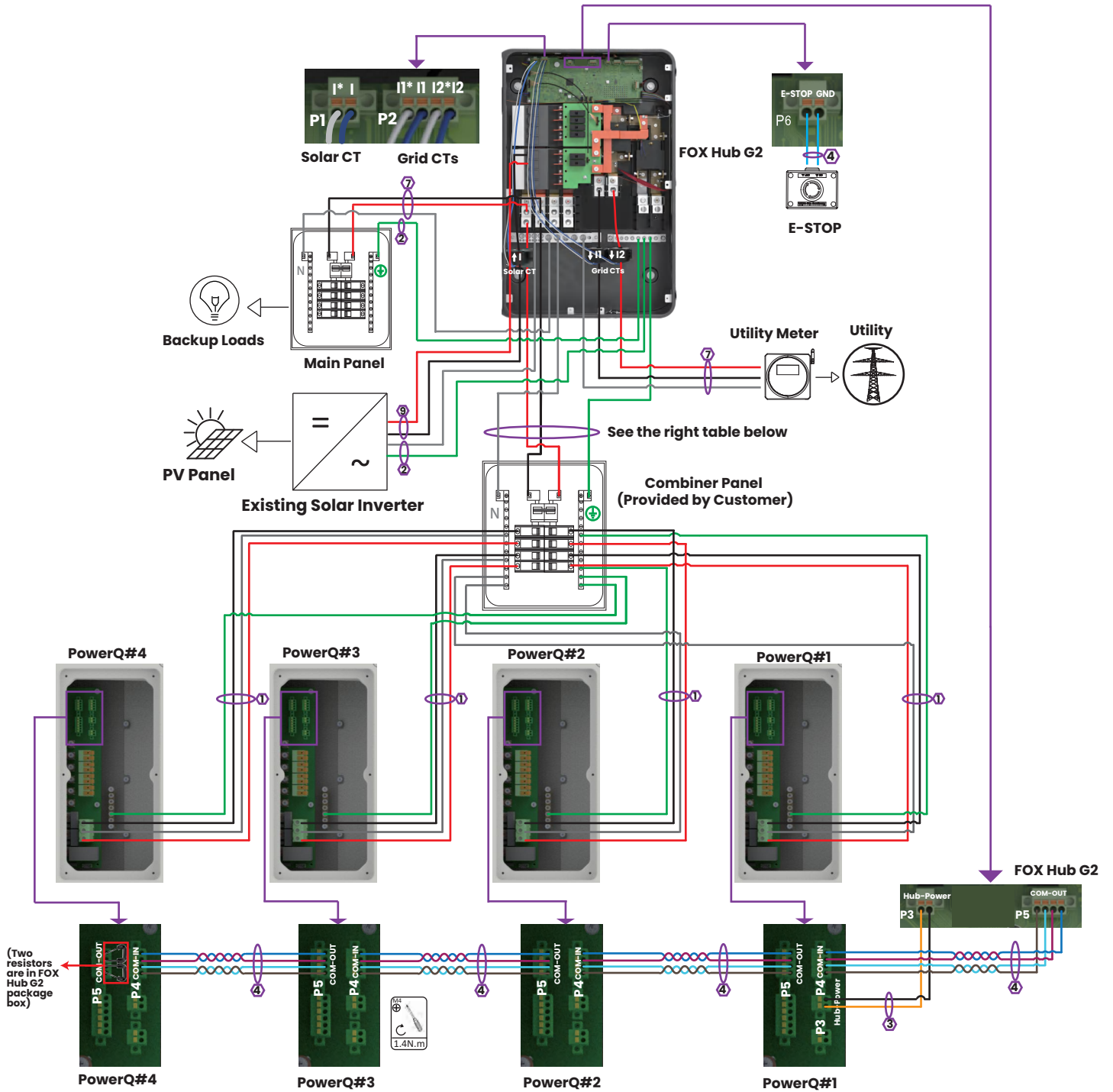

**Key**

- L1/Negative
- L2/Positive
- Ground
- Neutral
- Other Colors: Sensors/Communications

Wire Gauge Guide(copper)		
Label	Input Terminal	Conductor
1	BAT/AC IN/OUT/N/GND	6 AWG
2	AC IN/OUT/N/GND	6-2/0 AWG
3	Power	16 AWG
4	Signal Cable	24-16 AWG
5	Communication Cable	Ethernet Cable
6	MPPT	10 AWG
7	AC IN/OUT/N	6AWG-250 kcmil
8	AC IN/OUT/N	6-4/0 AWG
9	AC IN/OUT	6-1/0 AWG

No. of Parellel AIOs	Minimum Wire Gauge (Combiner Panel-FOX Hub G2)
2 Inverters	2 AWG
3 Inverters	2/0 AWG
4 Inverters	4/0 AWG



# Fox ESS Three-line Diagram (1 FOX Hub G2+Parallel Fox PowerQ Units)

## Partial-home Backup (DC Couple) (FOX Hub G2 as Service Panel)

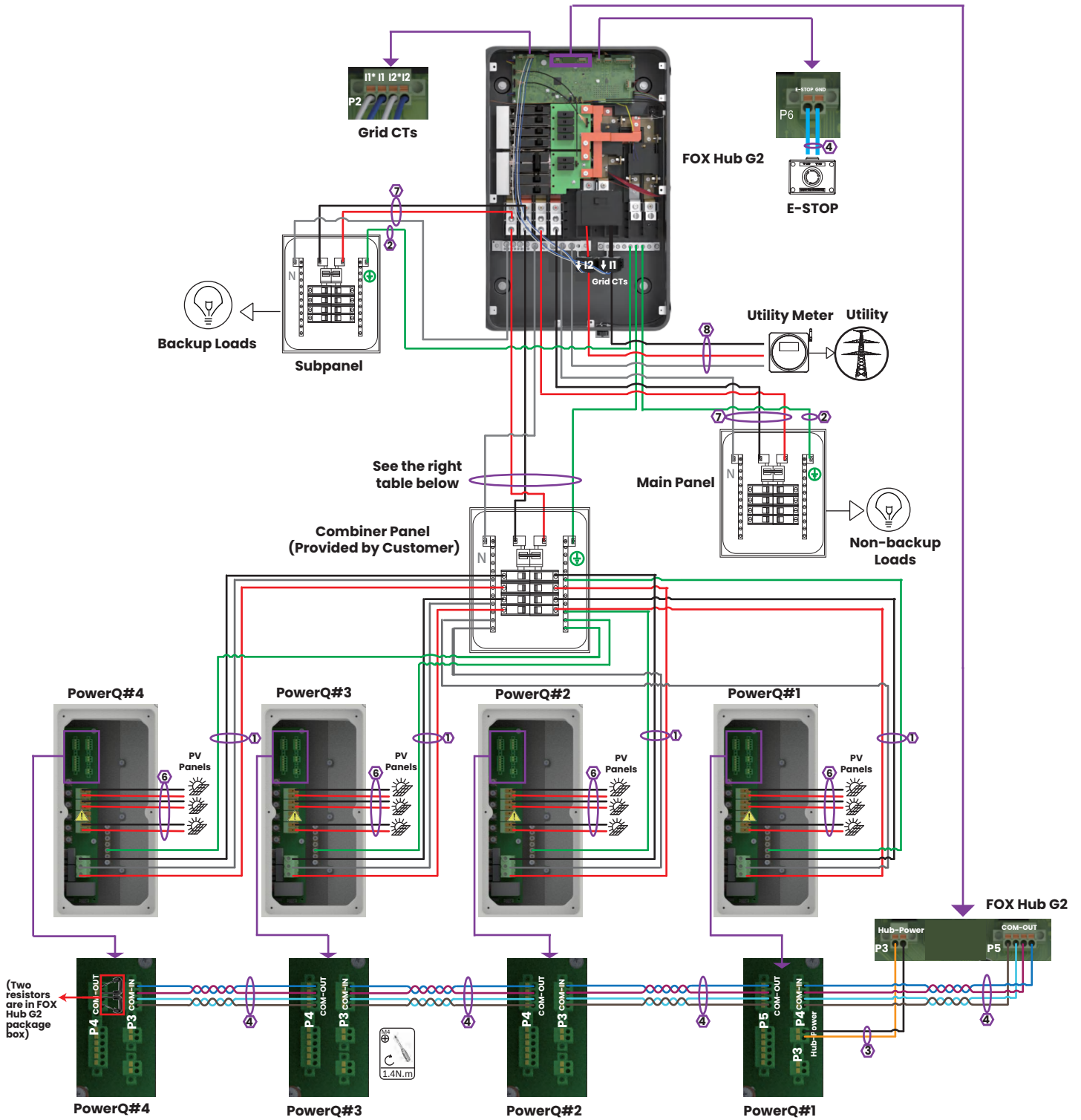

(Two resistors are in FOX Hub G2 package box)

Key	
●	L1/Negative
●	L2/Positive
●	Ground
●	Neutral
●	Other Colors: Sensors/Communications

Wire Gauge Guide(copper)		
Label	Input Terminal	Conductor
1	BAT/AC IN/OUT/N/GND	6 AWG
2	AC IN/OUT/N/GND	6-2/0 AWG
3	Power	16 AWG
4	Signal Cable	24-16 AWG
5	Communication Cable	Ethernet Cable
6	MPPT	10 AWG
7	AC IN/OUT/N	6AWG-250 kcmil
8	AC IN/OUT/N	6-4/0 AWG
9	AC IN/OUT	6-1/0 AWG

**⚠ Note**

\* If there are  $\leq 3$  PV strings, 3 PV strings are preferentially connected to terminals 1A+, 1A-, 2+, 2-, 3+, 3-.

\* If there are 4 PV strings, the number of PV panels connected to terminals 1A+, 1A- need to be the same as that connected to terminals 1B+, 1B-.

No. of Parellel AIOs	Minimum Wire Gauge (Combiner Panel-FOX Hub G2)
2 Inverters	2 AWG
3 Inverters	2/0 AWG
4 Inverters	4/0 AWG

# Fox ESS Three-line Diagram (1 FOX Hub G2+Parallel Fox PowerQ Units)

## Partial-home Backup (DC Couple) (FOX Hub G2 not as Service Panel)

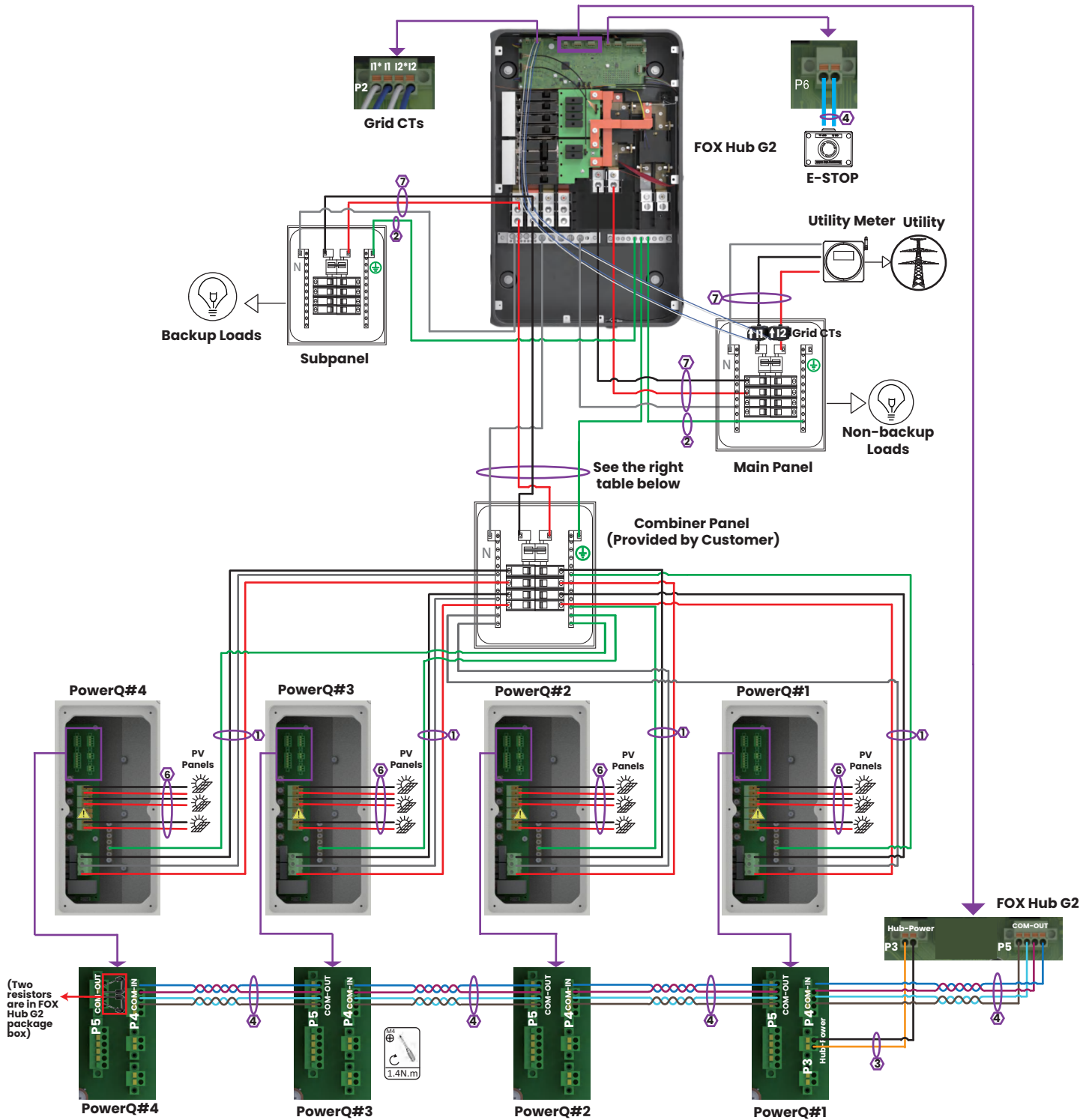

Wire Gauge Guide(copper)		
Label	Input Terminal	Conductor
1	BAT/AC IN/OUT/N/GND	6 AWG
2	AC IN/OUT/N/GND	6-2/0 AWG
3	Power	16 AWG
4	Signal Cable	24-16 AWG
5	Communication Cable	Ethernet Cable
6	MPPT	10 AWG
7	AC IN/OUT/N	6AWG-250 kcmil
8	AC IN/OUT/N	6-4/0 AWG
9	AC IN/OUT	6-1/0 AWG

Key	
●	L1/Negative
●	L2/Positive
●	Ground
●	Neutral
●	Other Colors: Sensors/Communications

**Note**

\* If there are ≤ 3 PV strings, 3 PV strings are preferentially connected to terminals 1A+, 1A-, 2+, 2-, 3+, 3-.

\* If there are 4 PV strings, the number of PV panels connected to terminals 1A+, 1A- need to be the same as that connected to terminals 1B+, 1B-.

No. of Parellel AIOs	Minimum Wire Gauge (Combiner Panel-FOX Hub G2)
2 Inverters	2 AWG
3 Inverters	2/0 AWG
4 Inverters	4/0 AWG

# Fox ESS Three-line Diagram (1 FOX Hub G2+Parallel Fox PowerQ Units)

## Partial-home Backup (AC Couple) (FOX Hub G2 as Service Panel)

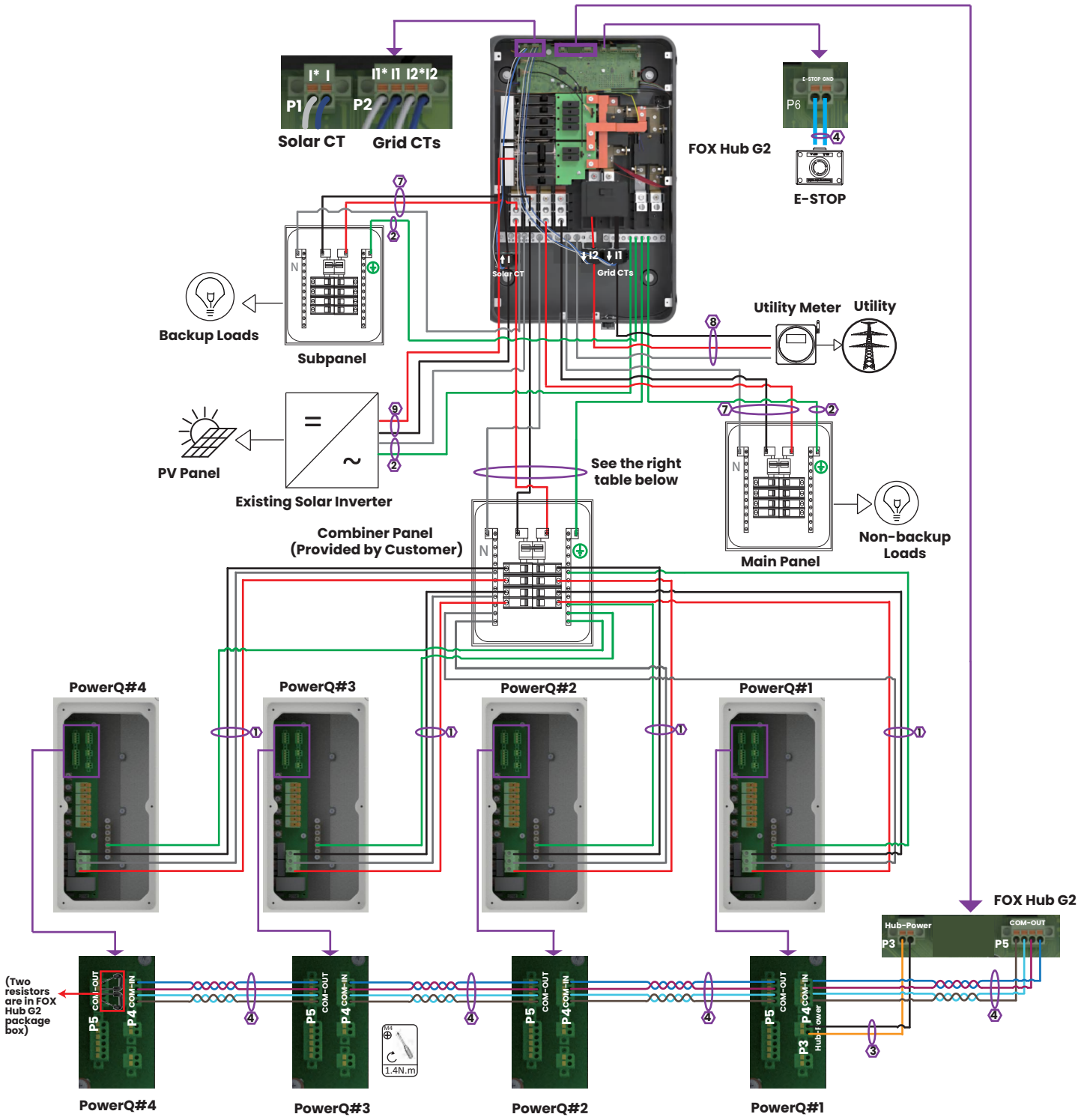

(Two resistors are in FOX Hub G2 package box)

**Key**

- L1/Negative
- L2/Positive
- Ground
- Neutral

Other Colors: Sensors/Communications

Wire Gauge Guide(copper)		
Label	Input Terminal	Conductor
1	BAT/AC IN/OUT/N/GND	6 AWG
2	AC IN/OUT/N/GND	6-2/0 AWG
3	Power	16 AWG
4	Signal Cable	24-16 AWG
5	Communication Cable	Ethernet Cable
6	MPPT	10 AWG
7	AC IN/OUT/N	6AWG-250 kcmil
8	AC IN/OUT/N	6-4/0 AWG
9	AC IN/OUT	6-1/0 AWG

No. of Parellel AIOs	Minimum Wire Gauge (Combiner Panel-FOX Hub G2)
2 Inverters	2 AWG
3 Inverters	2/0 AWG
4 Inverters	4/0 AWG

# Fox ESS Three-line Diagram (1 FOX Hub G2+Parallel Fox PowerQ Units)

## Partial-home Backup (AC Couple) (FOX Hub G2 not as Service Panel)

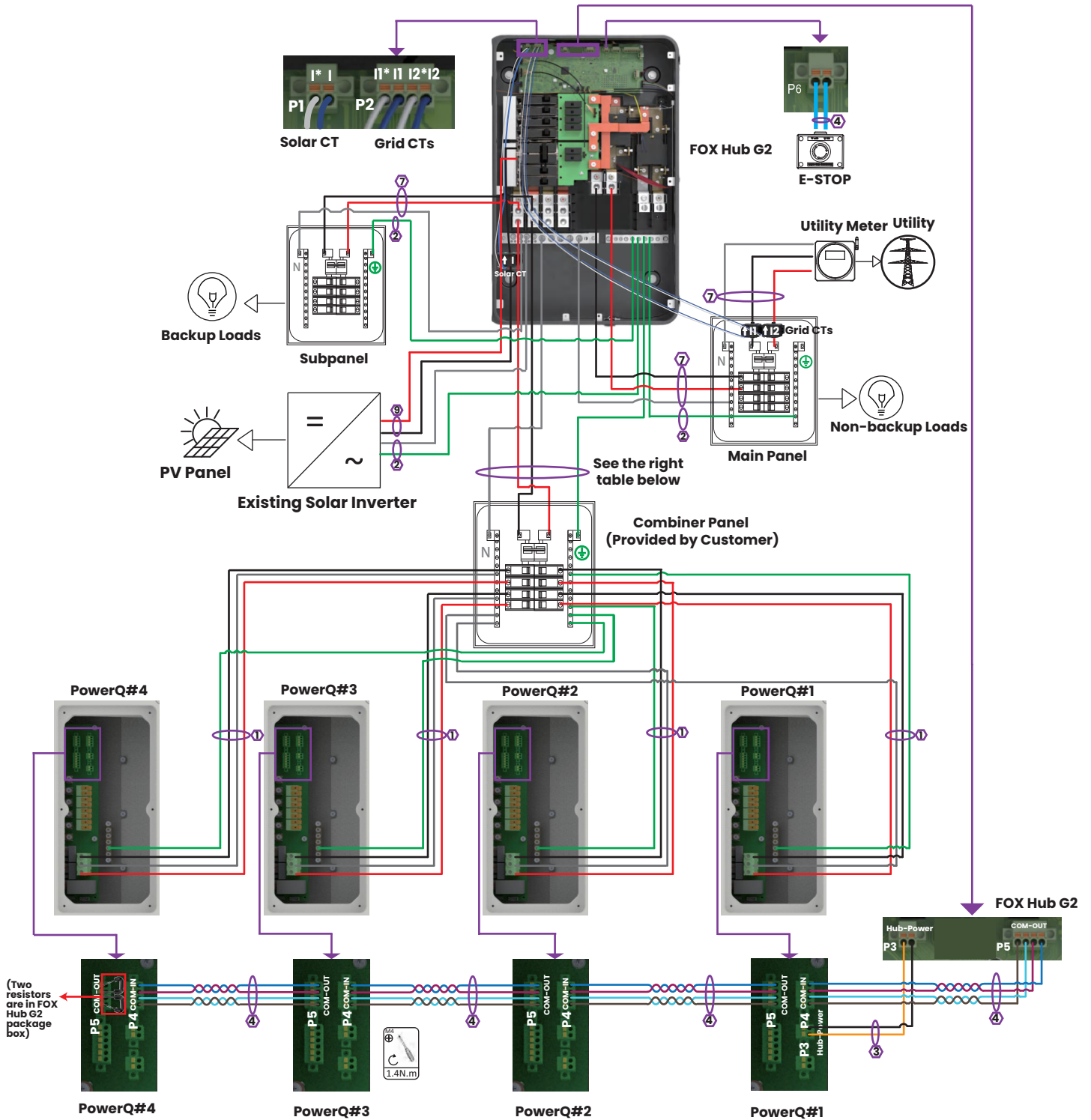

**Key**

- L1/Negative
- L2/Positive
- Ground
- Neutral

Other Colors: Sensors/Communications

Wire Gauge Guide(copper)		
Label	Input Terminal	Conductor
1	BAT/AC IN/OUT/N/GND	6 AWG
2	AC IN/OUT/N/GND	6-2/0 AWG
3	Power	16 AWG
4	Signal Cable	24-16 AWG
5	Communication Cable	Ethernet Cable
6	MPPT	10 AWG
7	AC IN/OUT/N	6AWG-250 kcmil
8	AC IN/OUT/N	6-4/0 AWG
9	AC IN/OUT	6-1/0 AWG

No. of Parellel AIOs	Minimum Wire Gauge (Combiner Panel-FOX Hub G2)
2 Inverters	2 AWG
3 Inverters	2/0 AWG
4 Inverters	4/0 AWG

# Fox ESS Three-line Diagram (1 FOX Hub G2+Parallel Fox PowerQ Units)

## Generator Wiring

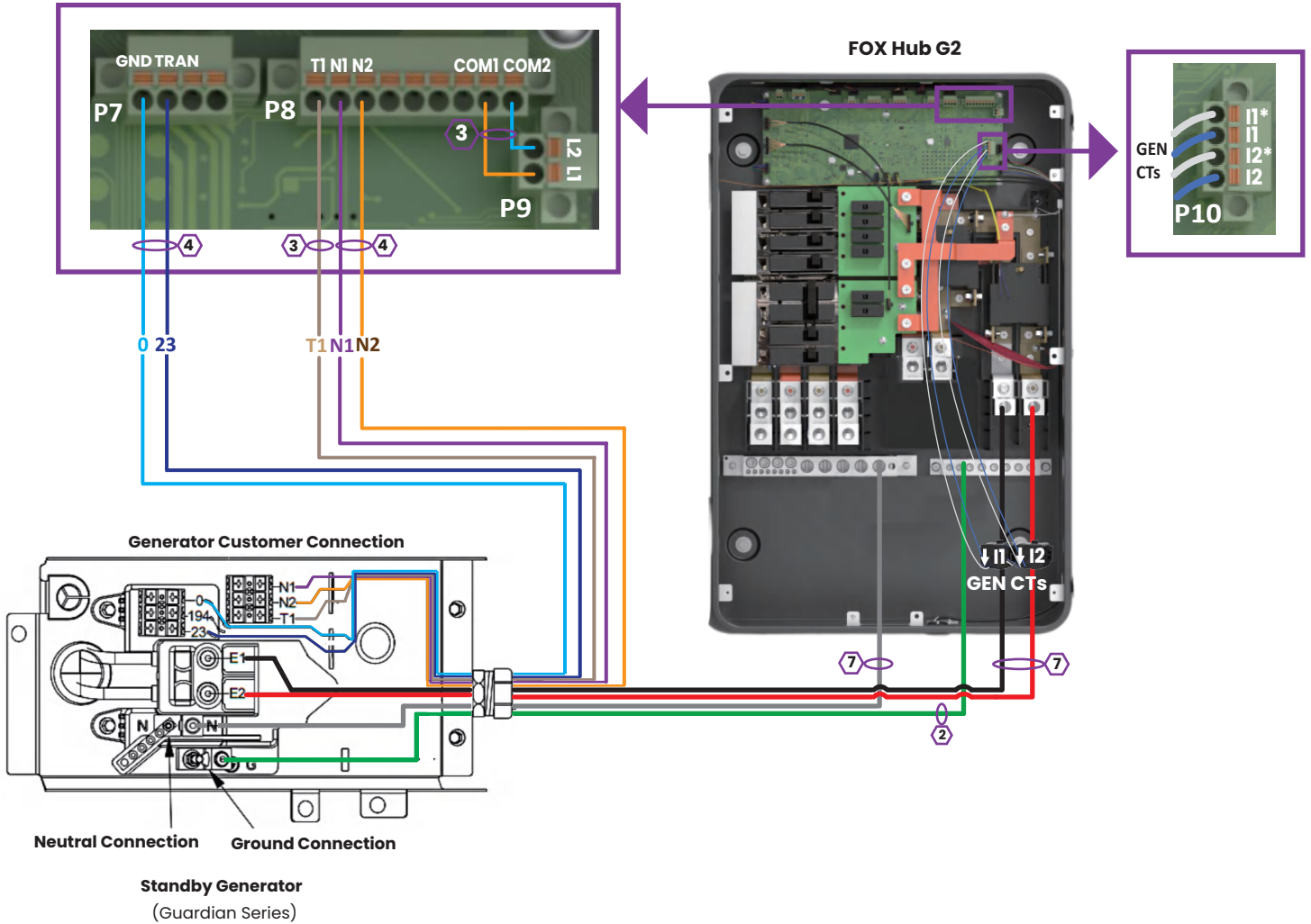

**Key**

- L1/Negative
- L2/Positive
- Ground
- Neutral

Other Colors: Sensors/Communications

Wire Gauge Guide(copper)		
Label	Input Terminal	Conductor
1	BAT/AC IN/OUT/N/GND	6 AWG
2	AC IN/OUT/N/GND	6-2/0 AWG
3	Power	16 AWG
4	Signal Cable	24-16 AWG
5	Communication Cable	Ethernet Cable
6	MPPT	10 AWG
7	AC IN/OUT/N	6AWG-250 kcmil
8	AC IN/OUT/N	6-4/0 AWG
9	AC IN/OUT	6-1/0 AWG

# Fox ESS Three-line Diagram (1 FOX Hub G2+Parallel Fox PowerQ Units)

## Smart Loads Wiring

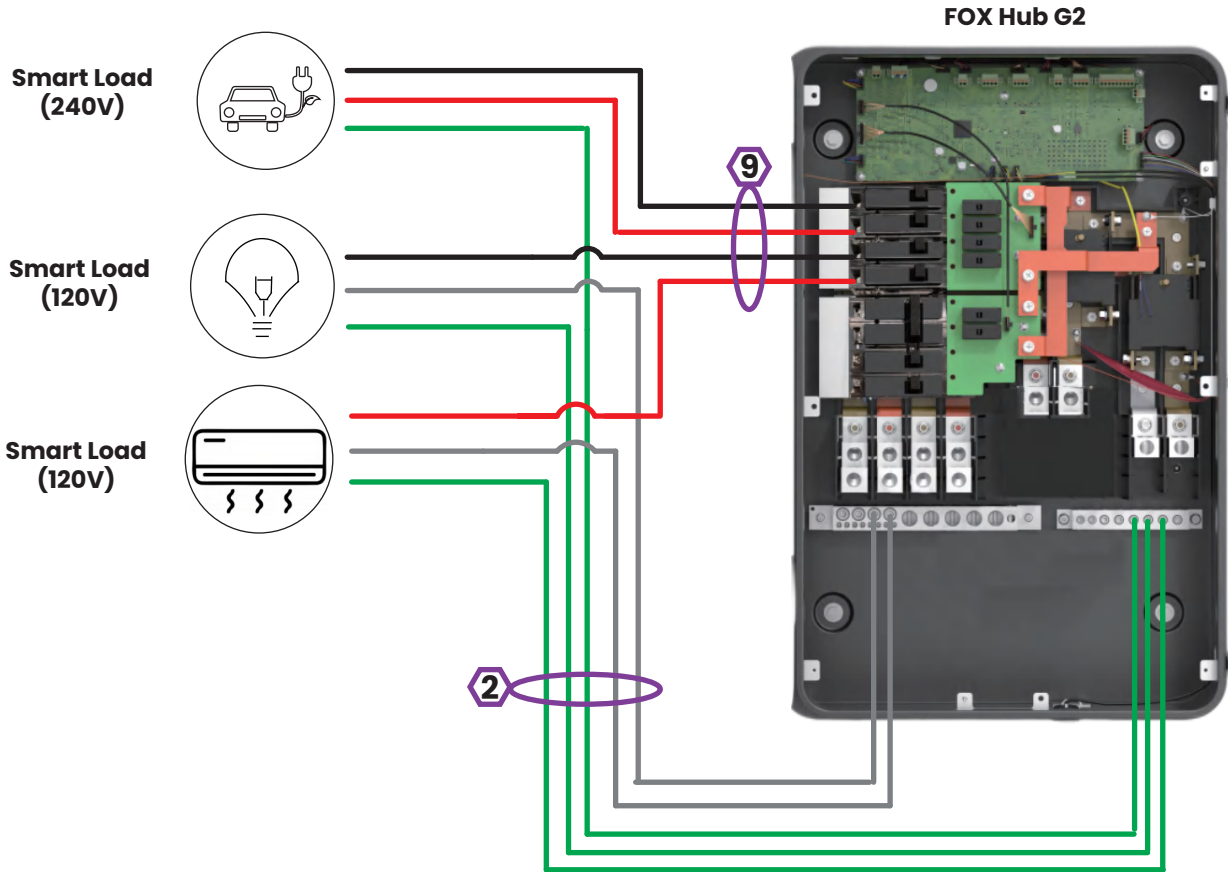

**Key**

- L1/Negative
- L2/Positive
- Ground
- Neutral

Other Colors: Sensors/  
Communications

Wire Gauge Guide(copper)		
Label	Input Terminal	Conductor
1	BAT/AC IN/OUT/N/GND	6 AWG
2	AC IN/OUT/N/GND	6-2/0 AWG
3	Power	16 AWG
4	Signal Cable	24-16 AWG
5	Communication Cable	Ethernet Cable
6	MPPT	10 AWG
7	AC IN/OUT/N	6AWG-250 kcmil
8	AC IN/OUT/N	6-4/0 AWG
9	AC IN/OUT	6-1/0 AWG



The copyright of this manual belongs to FOXESS CO., LTD. Any corporation or individual should not plagiarize, partially or fully copy (including software, etc.), and no reproduction or distribution of it in any form or by any means is permitted.

All rights reserved.

FOXESS CO., LTD.

Add: No. 939, Jinhai Third Road, New Airport Industry Area, Longwan District, Wenzhou,  
Zhejiang Province, China

Tel: 86-510-68092998

WWW.FOX-ESS.COM