

Fox PowerQ Energy Storage System

Quick Installation Guide

Issue: V1.1c
Date: 2025-10-13

FOXESS CO., LTD.



Contents

I Fox PowerQ Energy Storage System (with FOX Hub G2).....	1
1 Packing List.....	1
2 Required Tools.....	3
3 Installation Steps.....	4
4 System Wiring Diagram.....	8
5 System Wiring Steps.....	15
6 System Startup.....	39
7 Commissioning.....	40
II Fox PowerQ Energy Storage System (without FOX Hub G2).....	51
1 Packing List.....	51
2 Required Tools.....	52
3 Installation Steps.....	52
4 System Wiring Diagram.....	52
5 System Wiring Steps.....	54
6 System Startup.....	61
7 Commissioning.....	62

I Fox PowerQ Energy Storage System (with FOX Hub G2)

Notice

1. The information in this document may not be modified, copied or reproduced, in whole or in part, without the prior written permission of FOXESS CO., LTD. All information in this document is provided to the best of our knowledge and efforts, but does not constitute a warranty of any kind, express or implied. You can download quick guide and user manual by scanning the QR code.



2. Only certified electricians are allowed to operate the device. Operation personnel must wear proper personal protective equipment (PPE).
3. Before installing the device, check that the package contents are intact and complete against the packing list. If any damage is found or any component is missing, contact your dealer.
4. The device damage caused by the violation of instructions in this document is not covered under warranty.
5. The cable colors involved in this document are for reference only. Select cables in accordance with local cable specifications.
6. Fox PowerQ Energy Storage System has passed UL9540A unit level testing, suitable for residential indoor flooring installation
Testing Laboratory Name: CSA GROUP
Project Number: 80182817
Date of issue: April 2024

1 Packing List

1.1 Cube Inverter Package Box

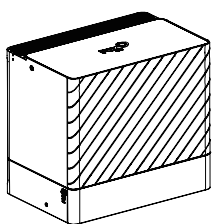

A

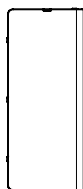

B

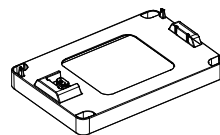

C



D

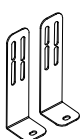

E

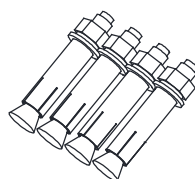

F



G



H

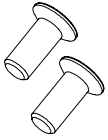

I

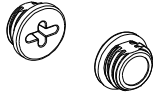

J

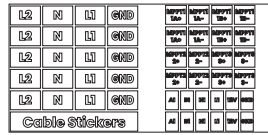

K



L

OBJ	QTY	DESC	OBJ	QTY	DESC
A	1	Cube Inverter	G	4	Expansion Tube & Expansion Screw
B	1	Side Cover	H	2	Handle
C	1	Base	I	2	Flat-head Screw
D	4	Set Screw	J	2	Screw Hole Cap
E	2	L-shaped Lugs	K	1	Cable Sticker
F	4	Sleeve Expansion Bolt M8*60	L	1	Quick Installation Guide

1.2 Battery Package Box

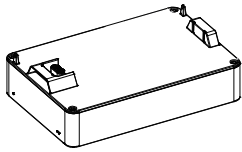

A



B

OBJ	QTY	DESC	OBJ	QTY	DESC
A	2-7	EQ4000	B	2	Set Screw

1.3 FOX Hub G2 Package Box



A

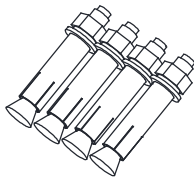

B



C



D

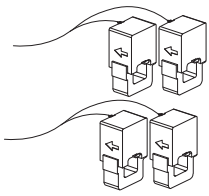

E

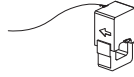

F

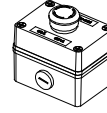

G

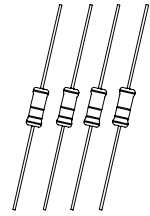

H

SUITABLE FOR USE AS SERVICE EQUIPMENT ONLY IN USA WHEN EQUIPPED WITH MAIN BREAKER

SERVICE DISCONNECT

WARNING: THIS SENSOR IS PART OF A POWER CONTROL SYSTEM. DO NOT REMOVE.

I

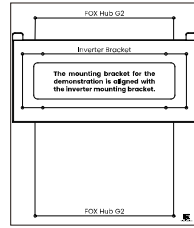

J



K

OBJ	QTY	DESC	OBJ	QTY	DESC
A	1	FOX Hub G2	G	1	E-STOP
B	4	Sleeve Expansion Bolt M8*60	H	4	60Ω Terminating Resistor
C	4	Waterproof Gasket	I	3	Label
D	1	Smart WiLAN/Smart 4GWiLAN (Optional)	J	1	Installation Paperboard
E	4	250A Current Transformer	K	1	Pry bar for relays
F	1	100A Current Transformer			

2 Required Tools

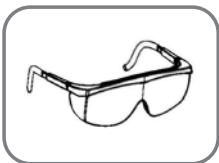

Safety Goggles

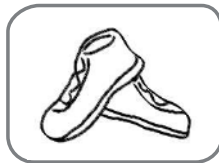

Steel Toe Boots

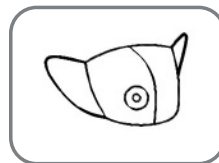

Dust Mask



Helmet



Insulating Gloves

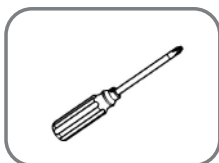

Phillips-Head Screwdriver

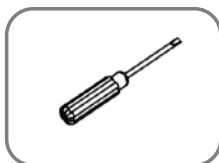

Flat-Head Screwdriver

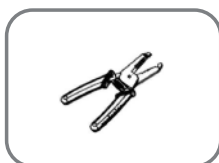

Wire Stripper



Electric Drill



Adjustable Wrench

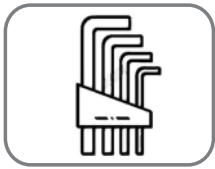

Hex Wrench Set

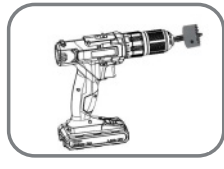

Hole Punch

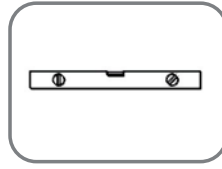

Level

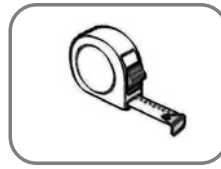

Tape



Sleeve

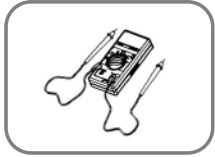

Multimeter



Phone



DANGER:

Special care must be taken to protect personal safety.

PPE must be worn during transfer and installation.



WARNING:

Please use proper protective measures, such as foam or protective cloth, keep the equipment well protected from hard objects that may damage their exterior appearance or body during handling and installation.

3 Installation Steps

3.1 Installation Environment

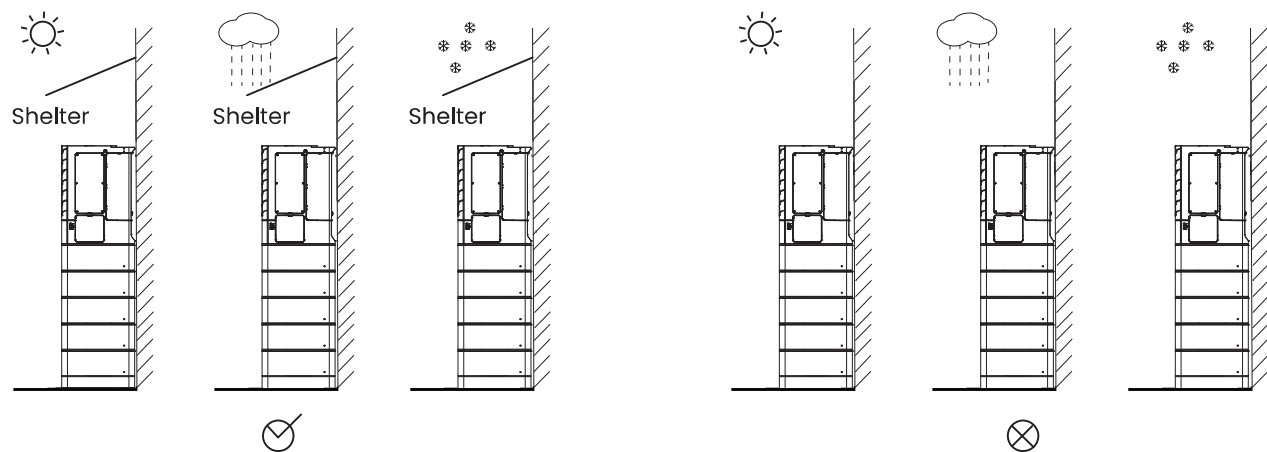

3.2 Size

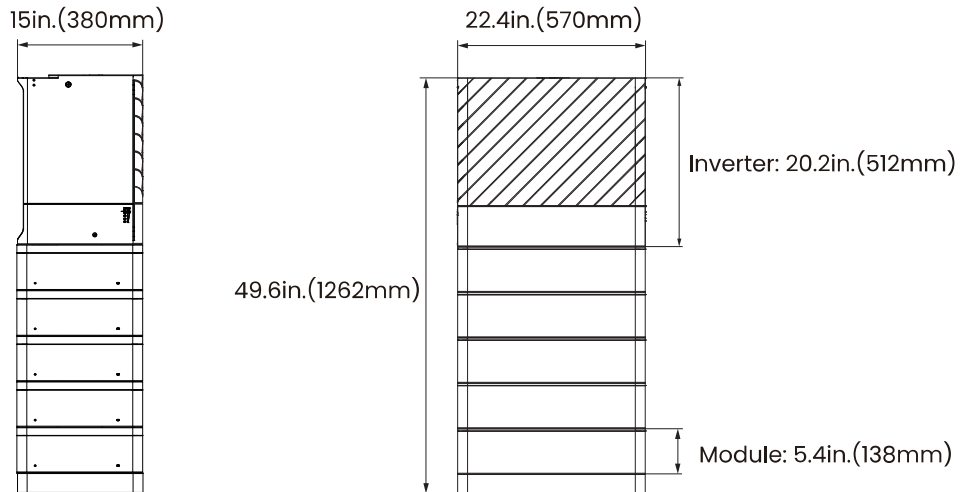

3.3 Installation Space

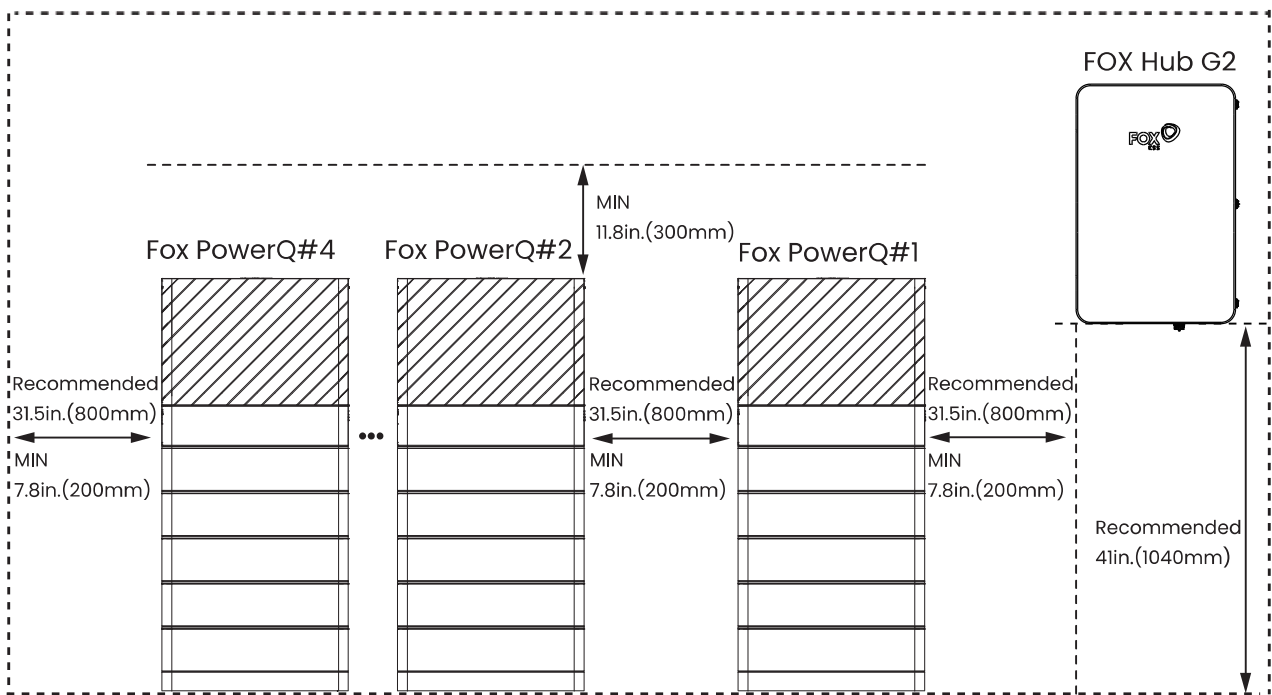

NOTE:



The minimum distance between the top of Fox PowerQ and the bottom of FOX Hub G2 is 300mm if the FOX Hub G2 is intalled directly above the Fox PowerQ.

3.4 Fox PowerQ Installation

• Installation on a Solid Ground

①

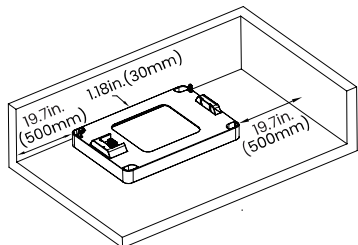

The base needs to be more than 1.18in. (30mm) against the wall.

②

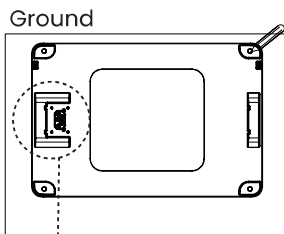

Ensure the connector is on the left side during base installation.

③

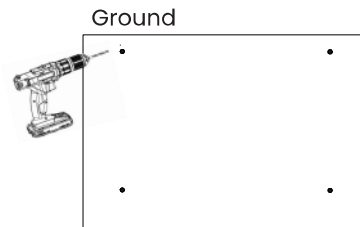

④

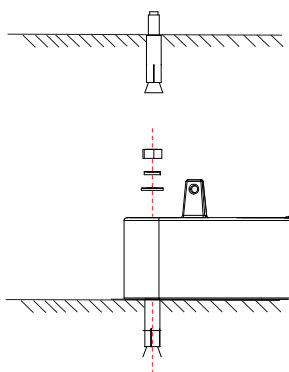

⑤

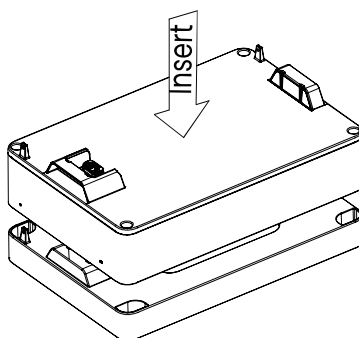

⑥

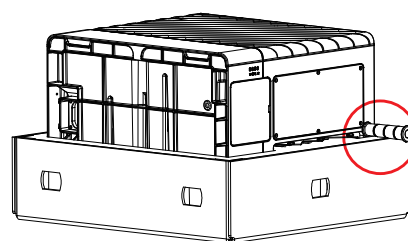

⑦

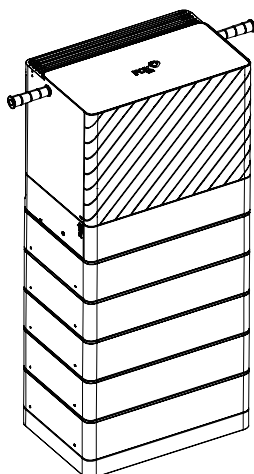

⑧

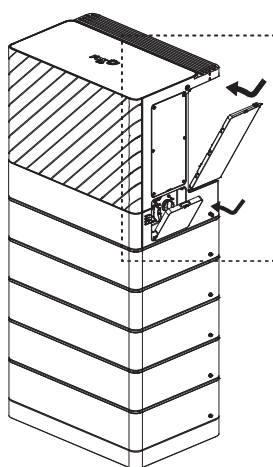

⑨

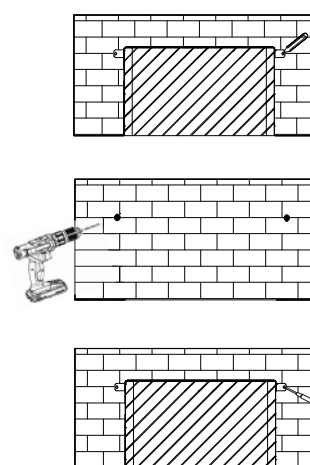

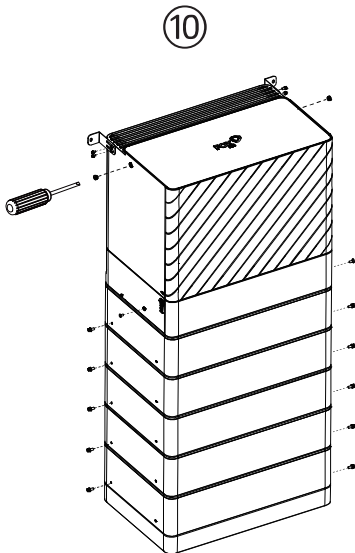

• **Installation on a Soft Ground**

- ① Prepare a cement slab with a dimension as shown in the figure on the right.
- ② Install Fox PowerQ in the middle of the cement slab to prevent cracking.
- ③ The following steps are the same as those in "Installation on a Solid Ground".

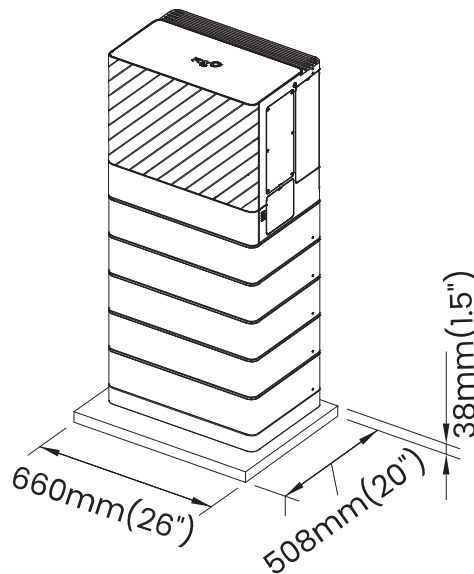

NOTE:



- All pipe connections need to be equipped with sealing gaskets and securely tightened.
- Apply sealant or wrap waterproof sealing tape to pipe joint gaps.
- If the installation extends overnight, refit all disassembled components and seal open conduits before leaving to prevent water ingress.

ATTENTION:



-Installer shall indicate the installed system power rating and energy capacity on the nameplate upon completion.

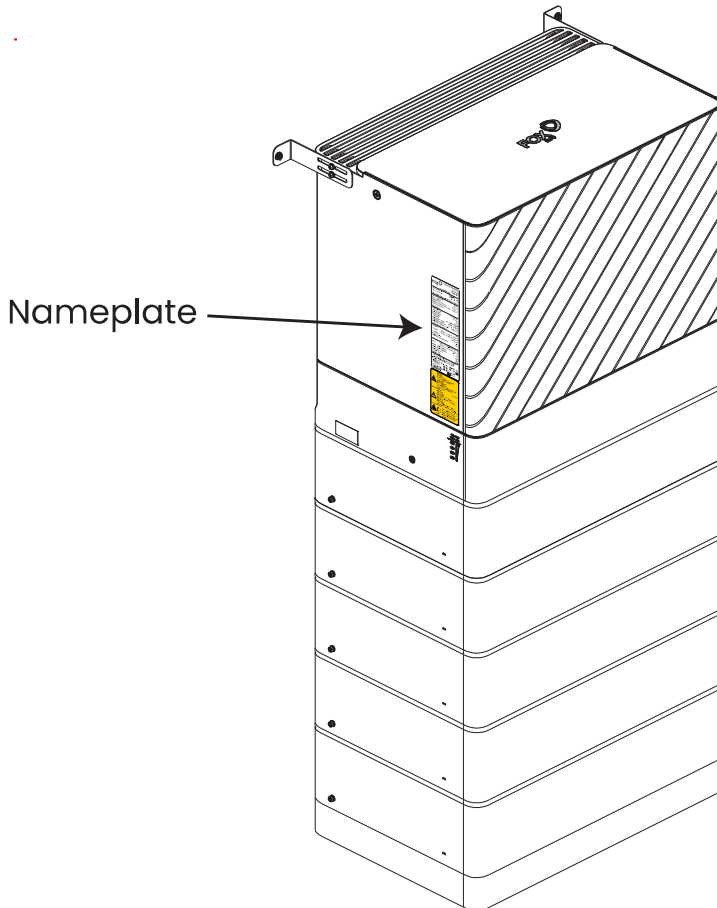

FOX ESS POWERQ (AC ESS) <small>www.fox-ess.com</small>	
SYSTEM MODEL	
US1H-11.4-EQLY	Y: 2 3 4 5 6 7
PV PARAMETERS (only for US1H-11.4-EQLY)	
MAXIMUM PV INPUT VOLTAGE	600 V d.c.
MPPT VOLTAGE RANGE	80-550 V d.c.
MAXIMUM INPUT CURRENT PER MPPT	28/14/14 A d.c.
MAXIMUM SHORT CIRCUIT CURRENT PER MPPT	44/22/22 A d.c.
NUMBER OF MPPT TRACKERS	3
AC OUTPUT	
NOMINAL GRID VOLTAGE	240 V a.c.: 2W+N+GND
GRID VOLTAGE RANGE	211-264 V a.c.
NOMINAL FREQUENCY	60 Hz
FREQUENCY RANGE	57-63 Hz
POWER FACTOR	>0.99 (0.8 leading-0.8 lagging)
MAXIMUM CONTINUOUS POWER	11.4 kW
MAXIMUM CONTINUOUS CURRENT*	47.5 A a.c.
MAXIMUM FAULT CURRENT AND DURATION	460A@37.187ms
BATTERY PARAMETERS	
BATTERY TYPE	Li-ion
TOTAL ENERGY	7.94 kWh <input type="checkbox"/> 11.91 kWh <input type="checkbox"/> 15.88 kWh <input type="checkbox"/> 19.85 kWh <input type="checkbox"/> 23.82 kWh <input type="checkbox"/> 27.79 kWh <input type="checkbox"/>
VOLTAGE RANGE	104.4-459.9 V d.c.
INGRESS PROTECTION	IP65
MAXIMUM CHARGE/DISCHARGE CURRENT	50 A d.c.
ENVIRONMENTAL PARAMETERS	
WEIGHT	128 kg (L2) <input type="checkbox"/> 165 kg (L3) <input type="checkbox"/> 202 kg (L4) <input type="checkbox"/> 239 kg (L5) <input type="checkbox"/> 276 kg (L6) <input type="checkbox"/> 313 kg (L7) <input type="checkbox"/>
AMBIENT OPERATING TEMPERATURE	-10°C ... 55°C
OPTIMUM OPERATING TEMPERATURE	0°C ... 30°C
ENCLOSURE TYPE (UL1741)	Type 4X
PROTECTIVE CLASS	Class I
MAXIMUM ELEVATION	2000 m
*MAXIMUM BYPASS CURRENT: 150A a.c.	
UL9540A, UL9540, UL1973, UL1741 SA, UL 1741 SB, UL1741 CRD, CSA C22.2 No.107.1-16, UL1998, UL1699B, HECO SRD-V2.0, IEEE1547-2018, IEEE1547a-2020, IEEE1547.1-2020, Rule21, FCC part15CLASS B	
GRID SUPPORT UTILITY INTERACTIVE INVERTER	
SUITABLE FOR USE IN RESIDENTIAL NON-HABITABLE SPACES	
Complies FCC ID: 2AC7Z-ESP32WROVERB	
FOXESS CO., LTD. <small>No.939, Jinhai Third Road, New Airport Industry Area, Longwan District, Wenzhou, Zhejiang, China</small>	

Remark: If a specific system power option is not available, marking is not required.

3.5 FOX Hub G2 Installation (Optional)

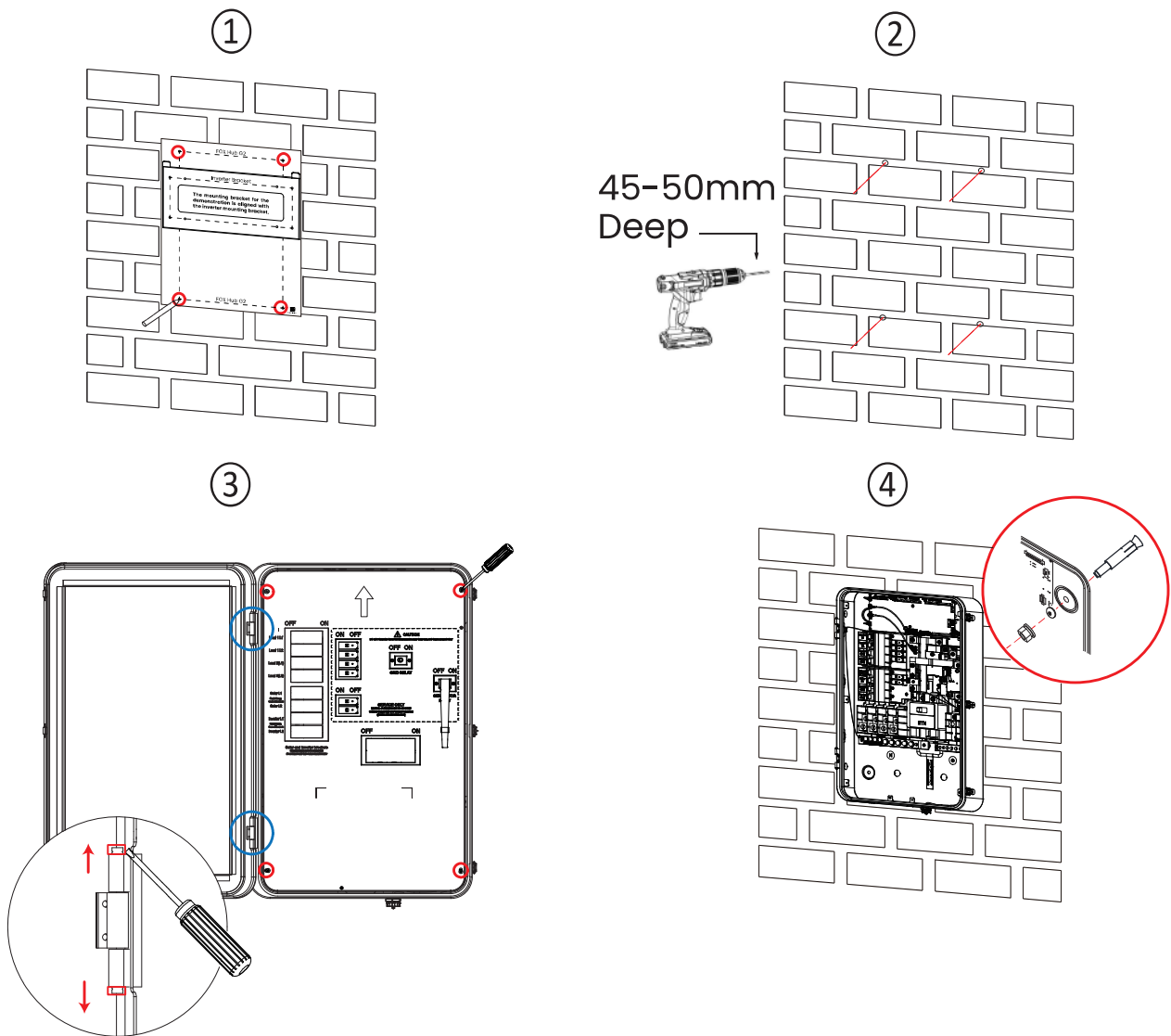

4 System Wiring Diagram

NOTE:

 Parallel operation requires inverters of identical models, and batteries matching in both model and capacity.

4.1 Whole-home Backup

NOTE:

 In **Canada**, the FOX Hub G2 cannot function as a service panel, so add a **Main Panel** as a service panel between the **FOX Hub G2** and **utility meter**.

Whole-home Backup (DC Couple)

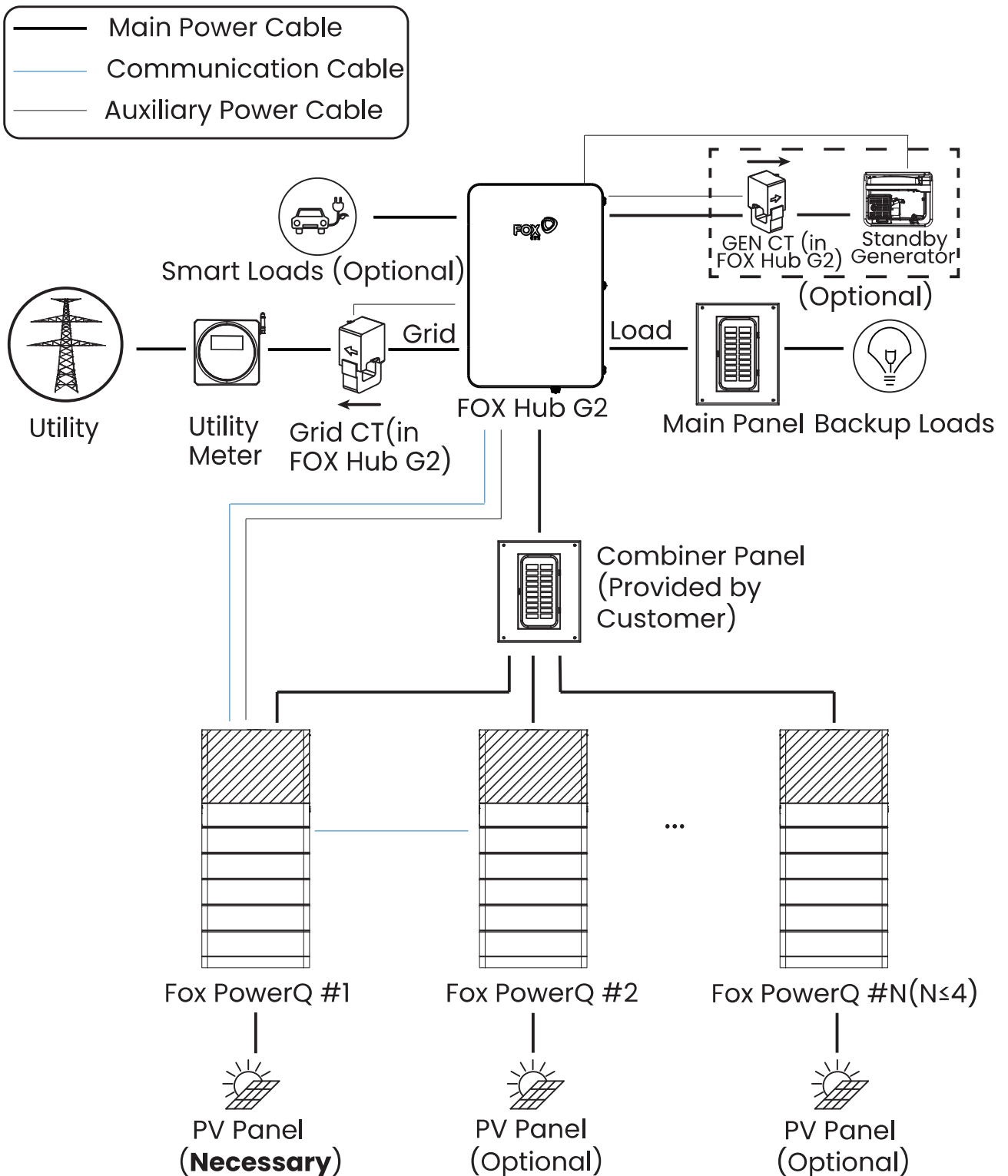

Whole-home Backup (AC Couple)

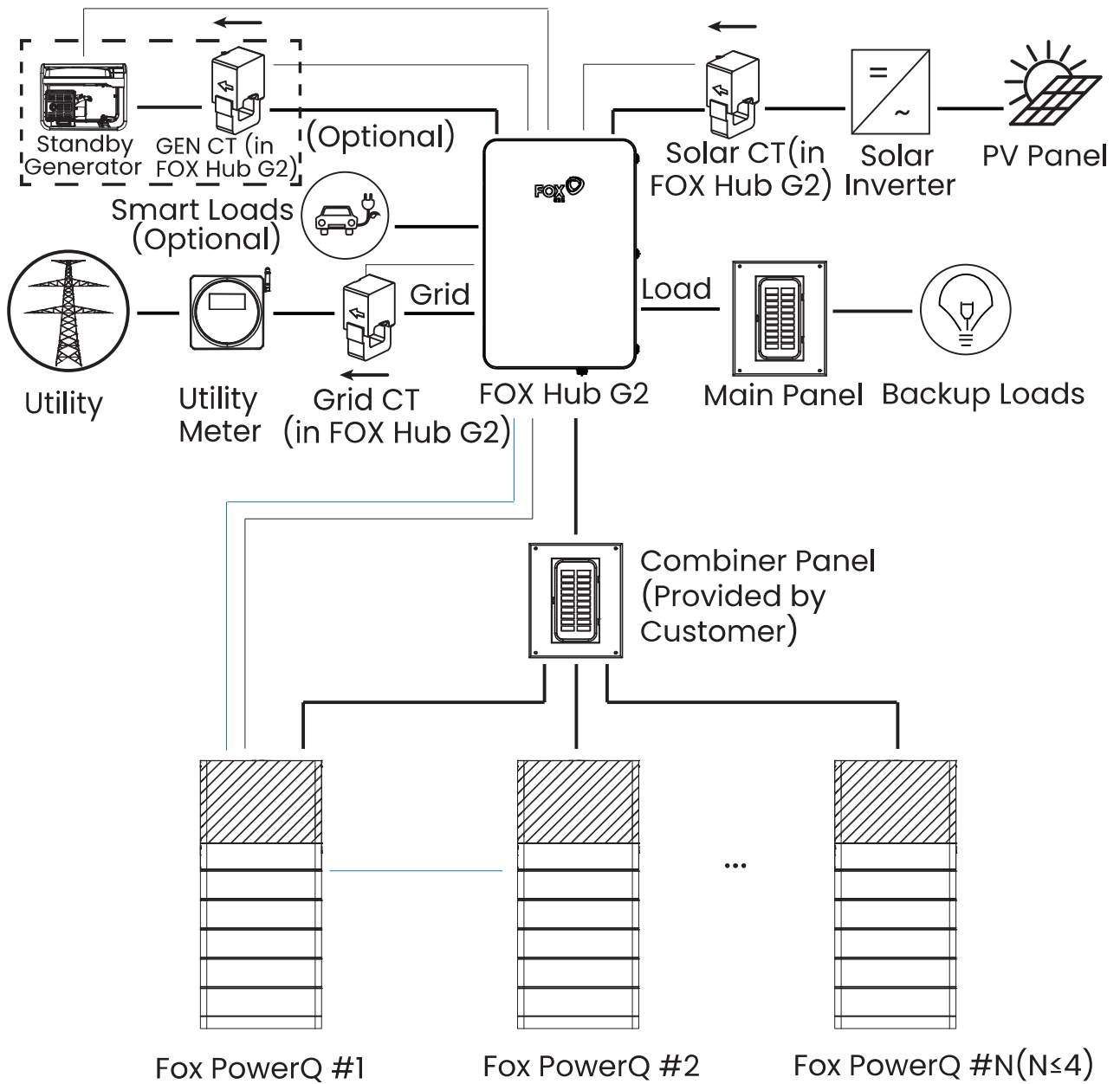
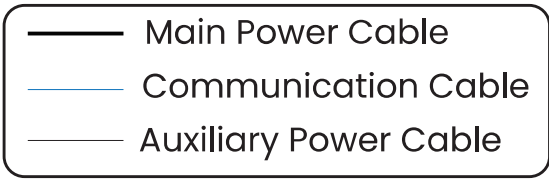

4.2.2 Partial-home Backup

NOTE:



In **Canada**, the FOX Hub G2 cannot function as a service panel. Utilize diagrams showing the FOX Hub G2 in non-service panel modes.

Partial-home Backup (DC Couple) (FOX Hub G2 as Service Panel)

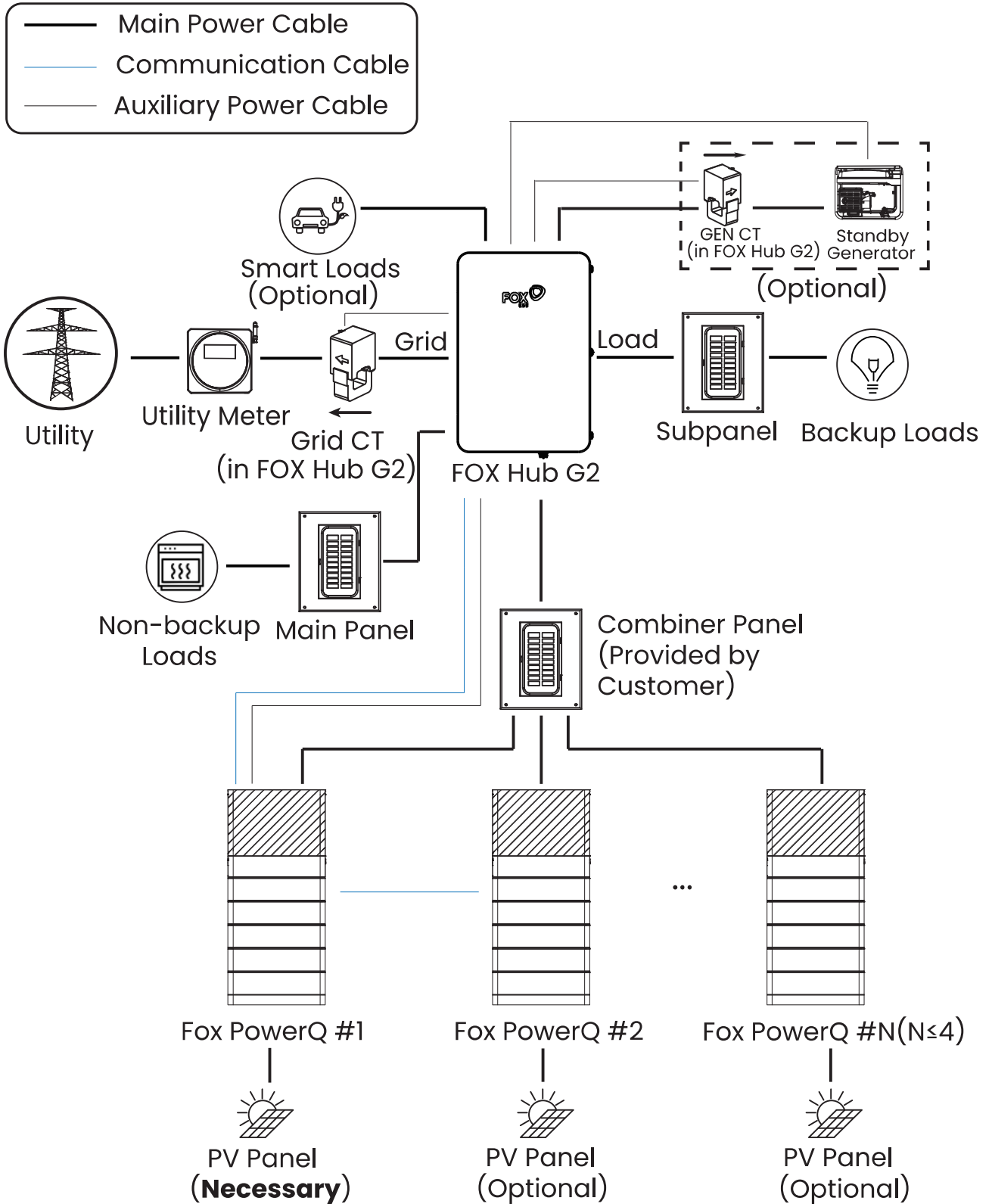

Partial-home Backup (DC Couple) (FOX Hub G2 not as Service Panel)

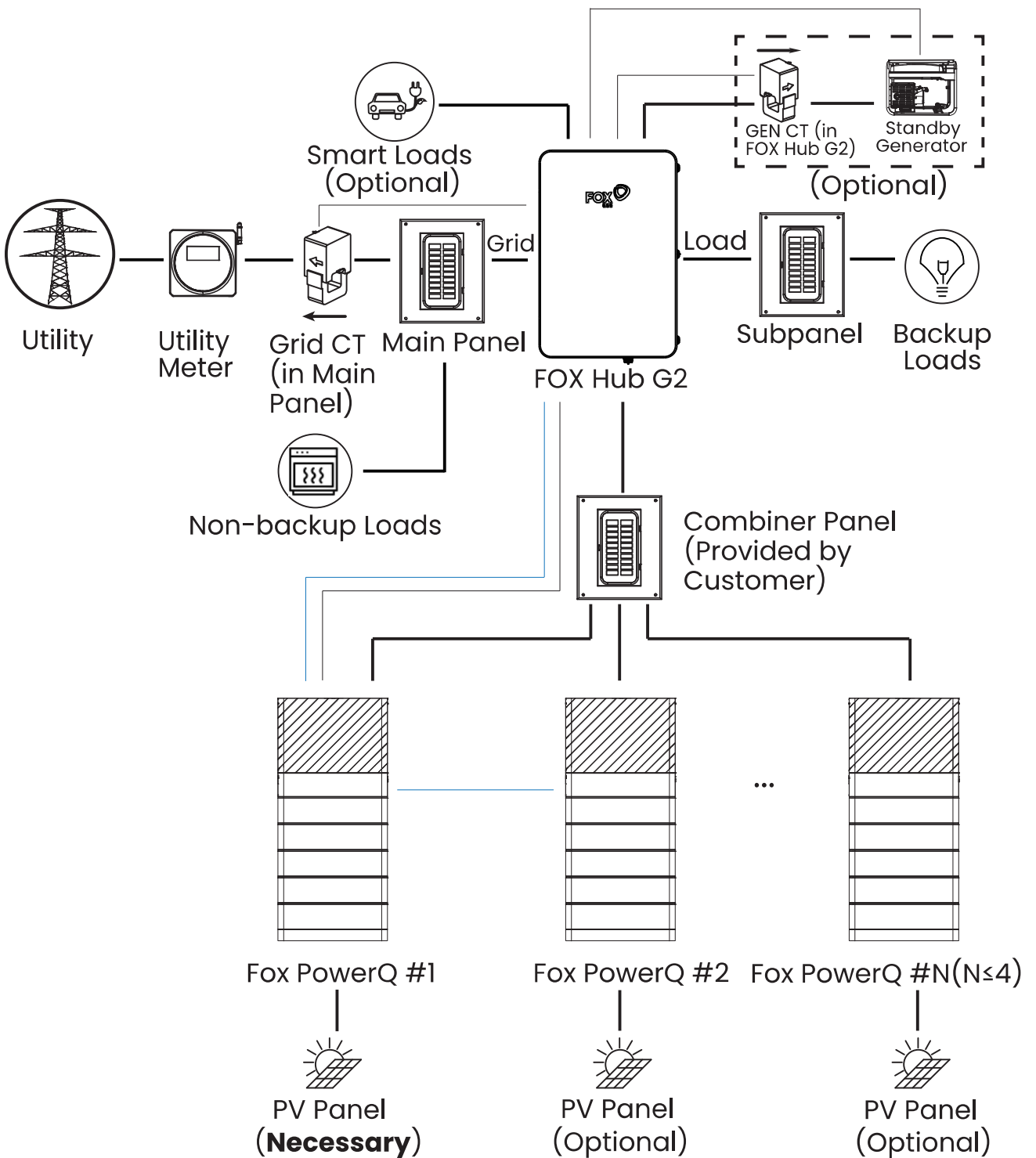
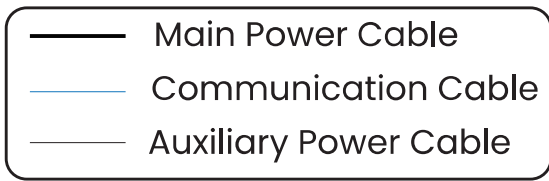

Partial-home Backup (AC Couple) (FOX Hub G2 as Service Panel)

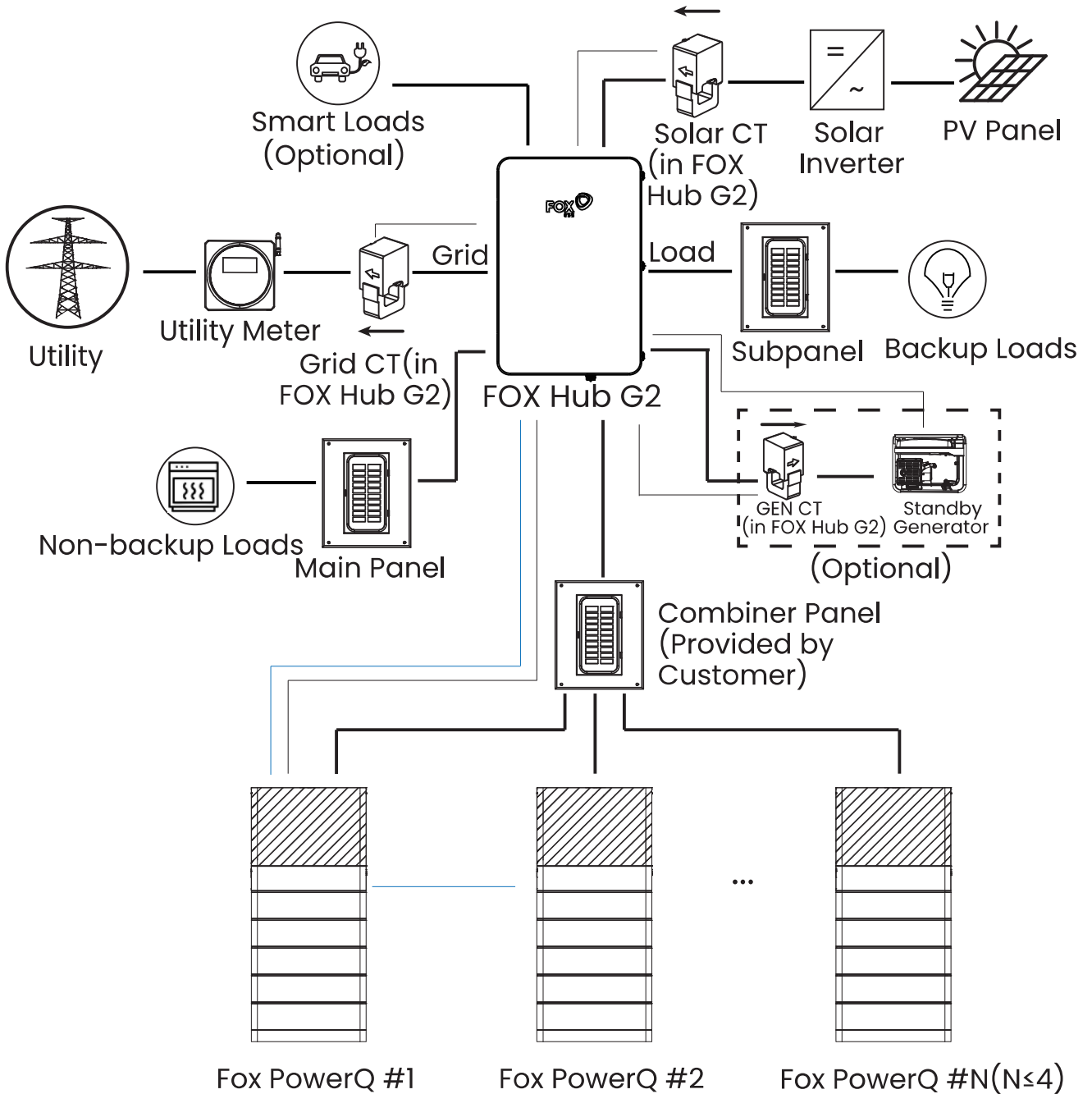
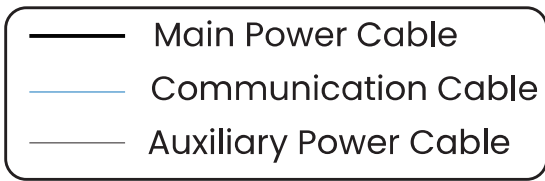

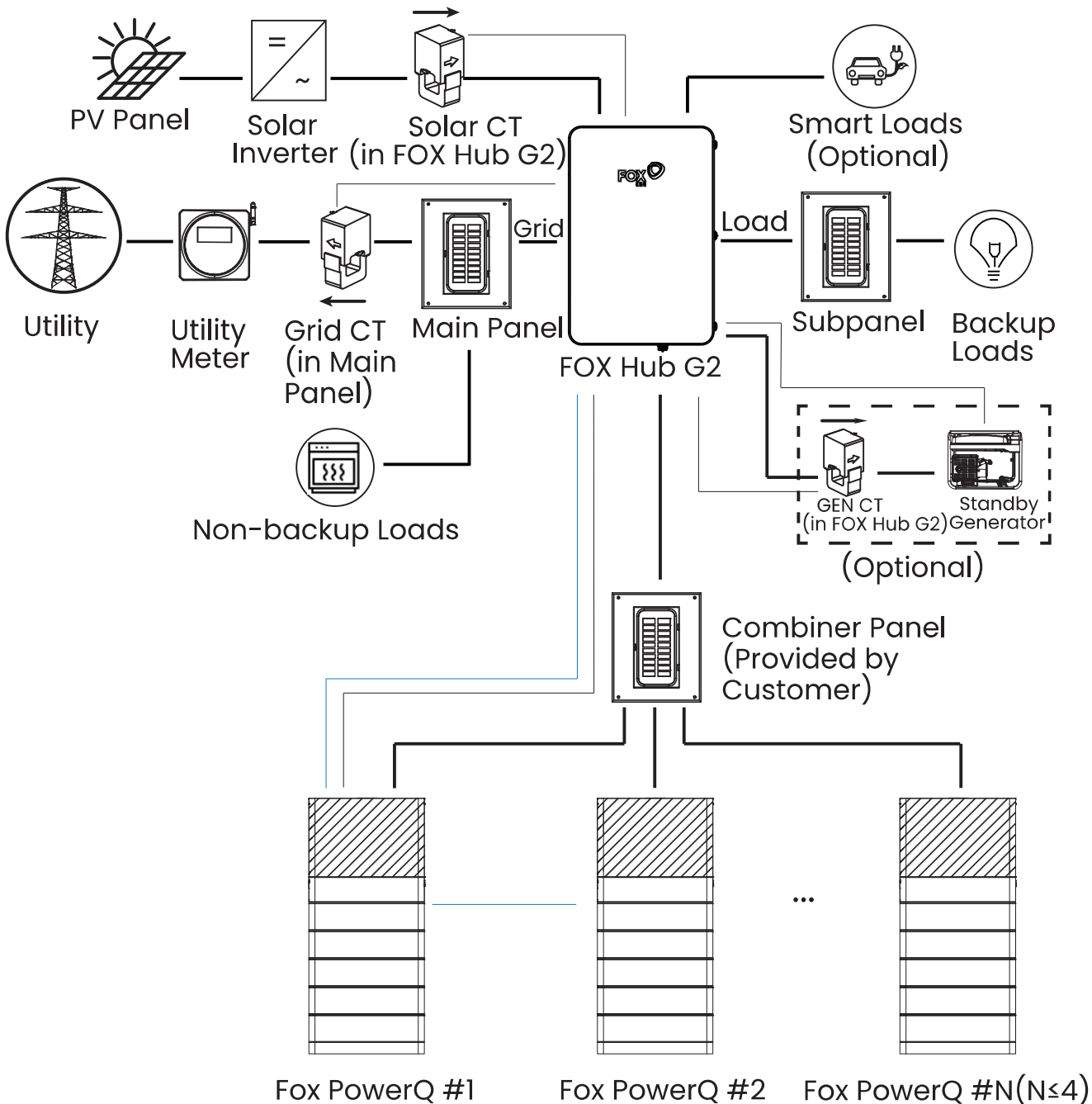
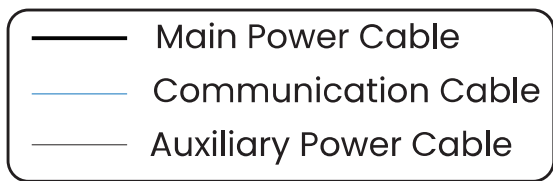

Partial-home Backup (AC Couple) (FOX Hub G2 not as Service Panel)

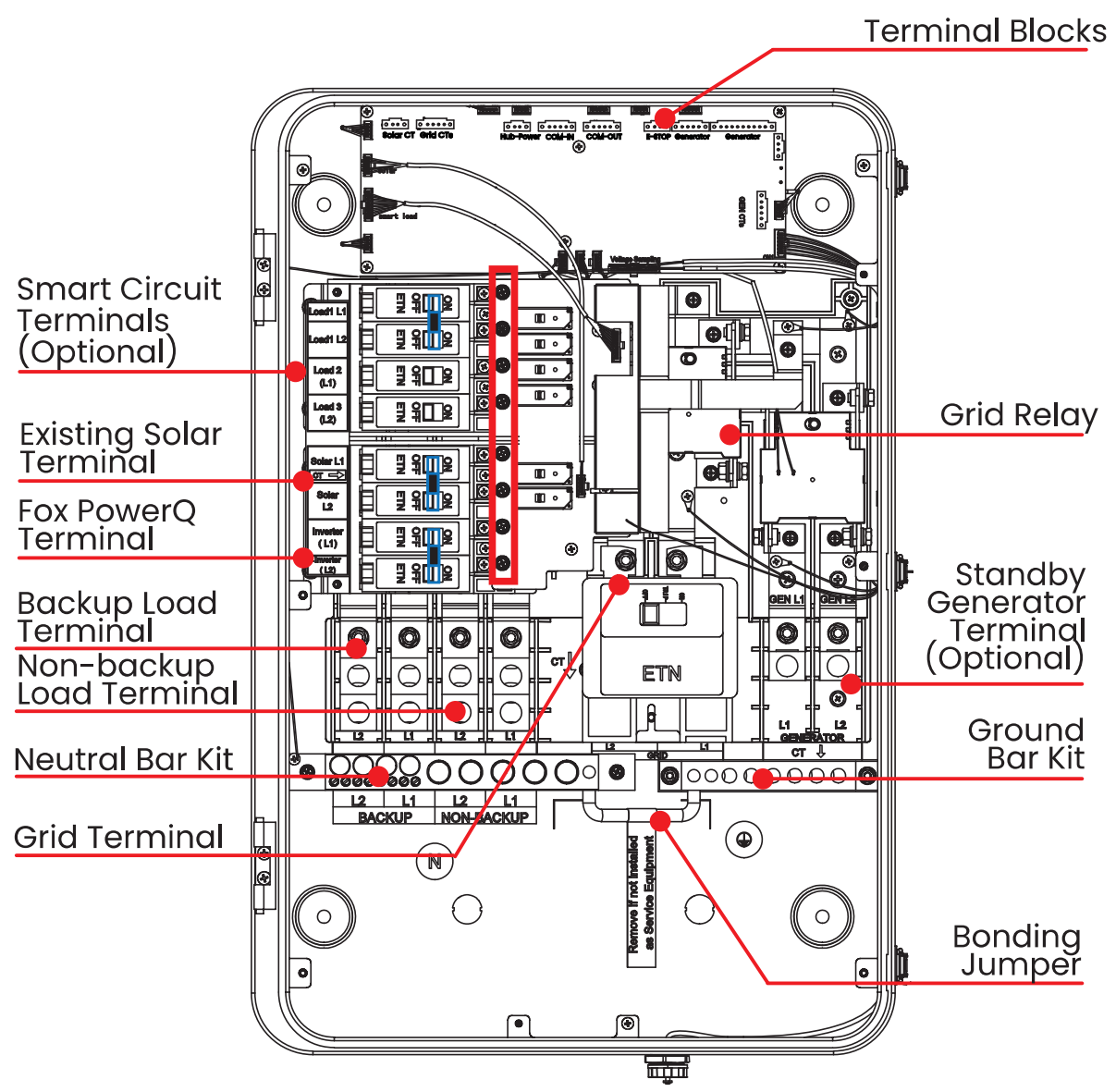

5 System Wiring Steps

5.1 FOX Hub G2 Overview



DANGER:  The framed screws are live. There is risk of electric shock. Disconnect units before servicing.

5.2 Is the FOX Hub G2 Installed as Service Panel?

- ① When the FOX Hub G2 is used as the service panel,
- a. main breaker and line side barriers (Eaton TICSR300C) need to be installed;

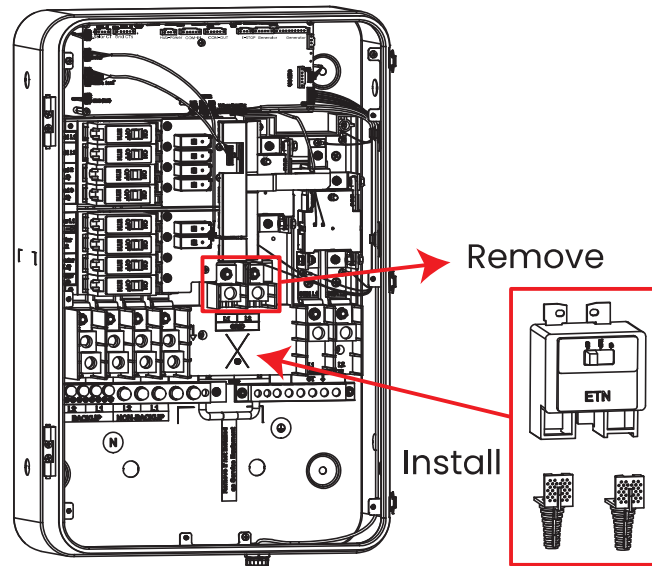

- b. labels of "SERVICE DISCONNECT" and "SUITABLE FOR USE AS SERVICE EQUIPMENT ONLY IN USA WHEN EQUIPPED WITH MAIN BREAKER" shall be applied to the black protection cover.

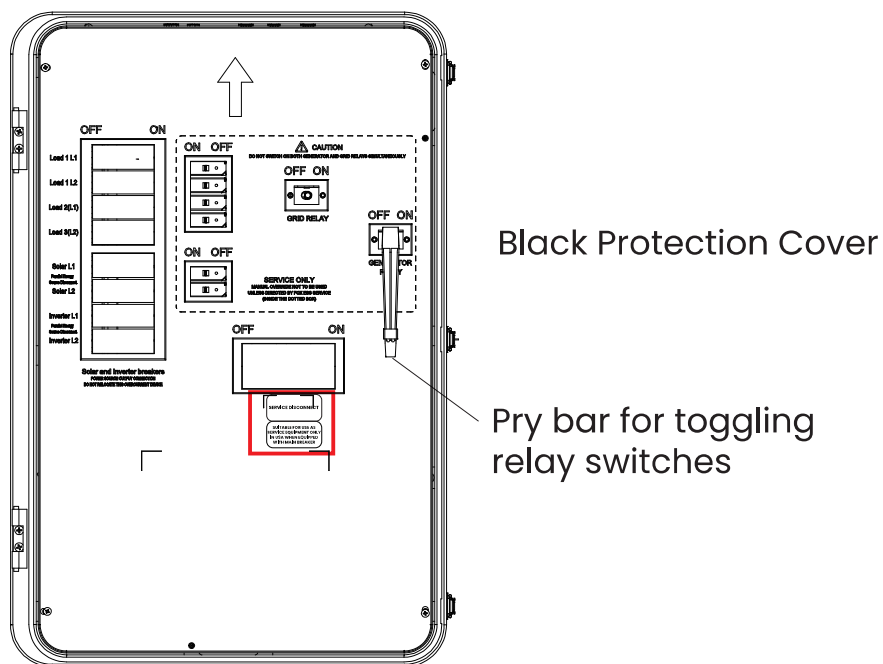

Warning:



- ① Do not switch on both generator and grid relays simultaneously.
- ② Before toggling the two relays, please disconnect the AC breaker and shut down the PowerQ.

② When the FOX Hub G2 is not used as the service panel, bonding jumper needs to be removed.

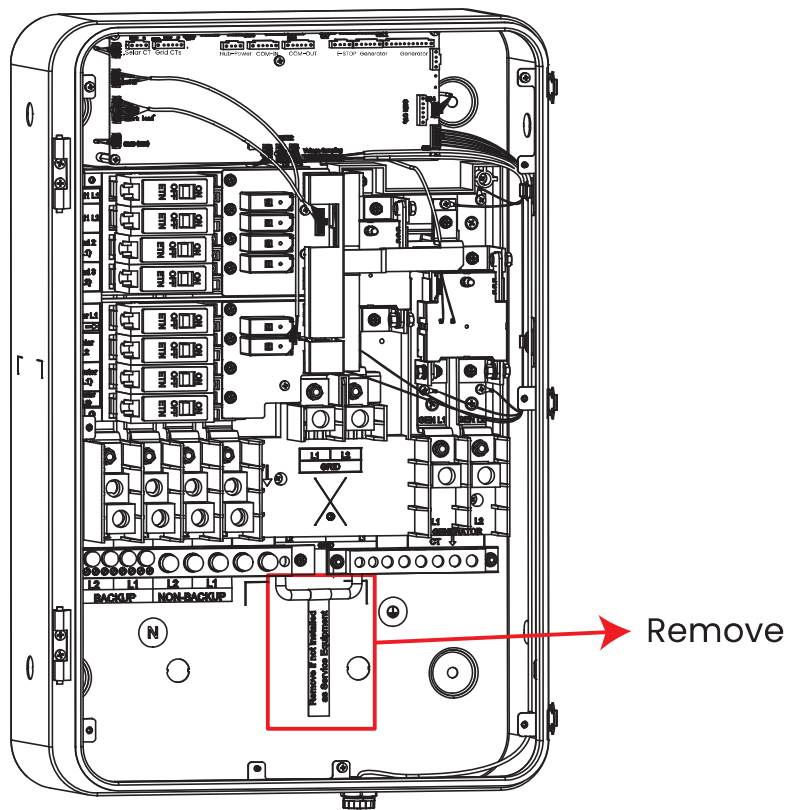

③ Recommended Breaker Models

Circuit	Compatible Breaker
Smart Circuit (Back-fed breaker) (Optional)	CH230, CH235, CH240, CH245, CH250, CH260, CH270, CH280, CHF230, CHF235, CHF240, CHF245, CHF250, BR230, BR240, BR250, BR260, BR270, BR280, BR290, BRH230, BRH240, BRH 250, BRH260, BRH270, BRH 280, BRH 290, BR170, BR160, BR150, BR140, BR130, BRH170, BRH160, BRH150, BRH140, BRH130
Existing Solar (Branch breaker)	CH230, CH235, CH240, CH245, CH250, CH260, CH270, CH280, CHF230, CHF235, CHF240, CHF245, CHF250, BR230, BR240, BR250, BR260, BR270, BR280, BR290, BRH230, BRH240, BRH 250, BRH260, BRH270, BRH 280, BRH 290
Fox PowerQ (Branch breaker)	CH260, CH270, CH280, BR260, BR270, BR280, BR290, BRH260, BRH270, BRH 280, BRH 290
Grid (Main breaker) (Optional)	CSR2100, CSR2125N, CSR2150N, CSR2175N, CSR2200N, BW2100, BW2125, BW2150, BW2175, BW2200, BWH2100N, BWH2125N, BWH2150N, BWH2175N, BWH2200N

④ NEC 2023 Requirement of Current rating:

1.705.12 (b)(1): bus bar rating shall not less than main breaker rating + breaker of other power source (125% of power source output)

2.705.12 (b)(2): only two power sources: primary power source is located on opposite end of other power source. Bus bar rating x 120% shall not less than main breaker rating + breaker of another power source (125% of power source output). Need following marking: POWER SOURCE OUTPUT CONNECTION. DO NOT RELOCATE THIS OVERCURRENT DEVICE

3.705.12 (b)(3): The sum of overcurrent protection device excluding main breaker shall not more than bus bar rating. And main breaker shall not more than bus bar rating. Need following marking:

WARNING:

THIS EQUIPMENT FED BY MULTIPLE SOURCES. TOTAL RATING OF ALL OVERCURRENT DEVICES EXCLUDING MAIN SUPPLY OVERCURRENT DEVICE SHALL NOT EXCEED AMPACITY OF BUSBAR.

5.3 FOX Hub G2 Power Cable Wiring

- Size of Conduit and Cable Gland

FOX Hub G2			
Cable Marker	Max. Cable Diameter	Conduit	Gland
L1	4/0 AWG	EMT 2"	M75 or adapts to 2" EMT conduit
L2	4/0 AWG		
N	4/0 AWG		
PE	4 AWG		

Fox PowerQ			
Cable Marker	Max. Cable Diameter	Conduit	Gland
L1	6 AWG	EMT 2"	M75 or adapts to 2" EMT conduit
L2	6 AWG		
N	6 AWG		
PE	6 AWG		

- Recommended Routing: Through Bottom Cable Bridge, Then Into Interface

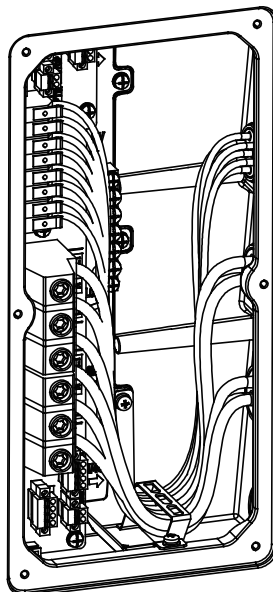

Fox PowerQ

- The Fox PowerQ Connections to the FOX Hub G2 (One Fox PowerQ unit)

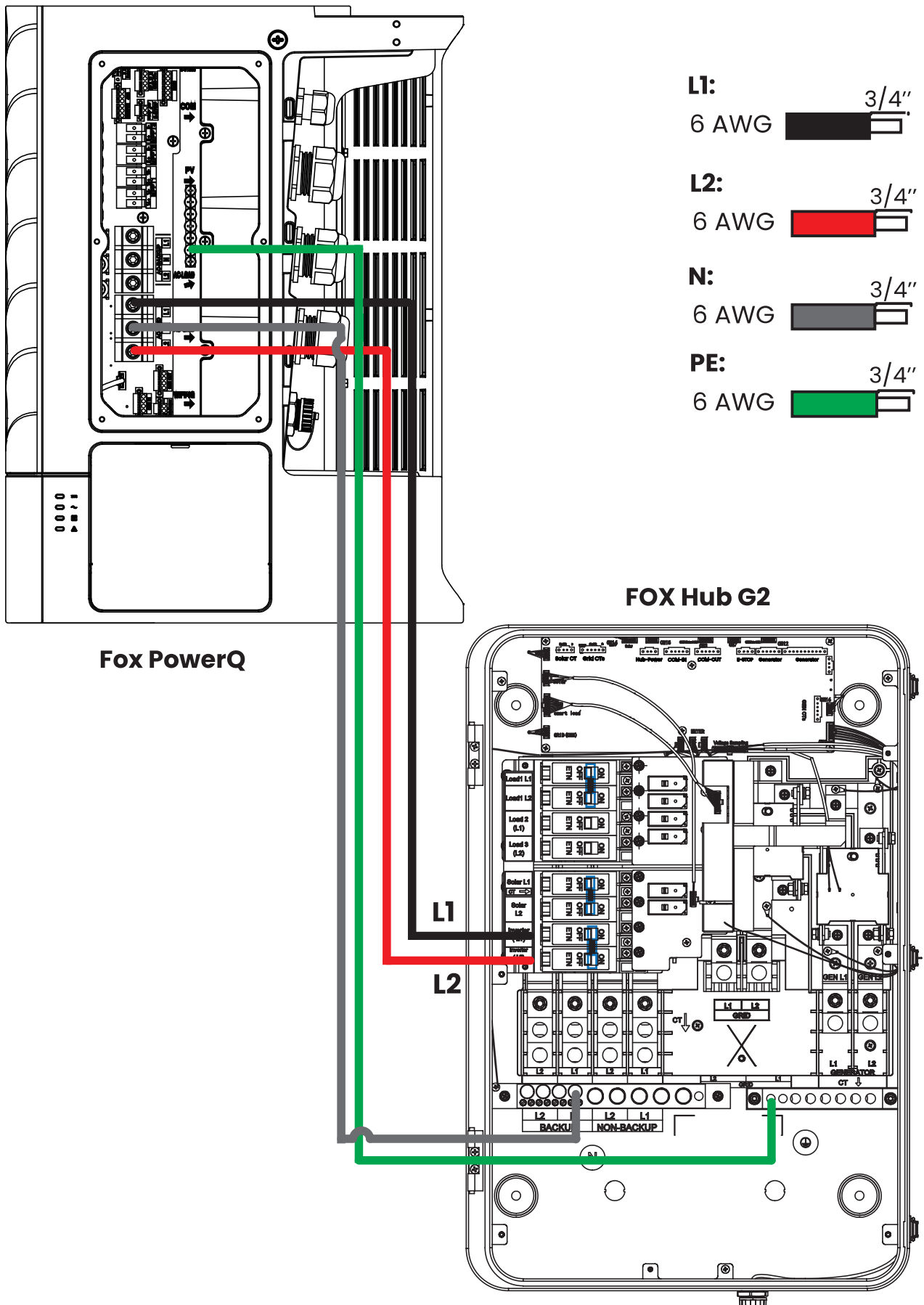

- The Fox PowerQ Connections to the FOX Hub G2 (via Combiner Panel) (2 to 4 Fox PowerQ units)

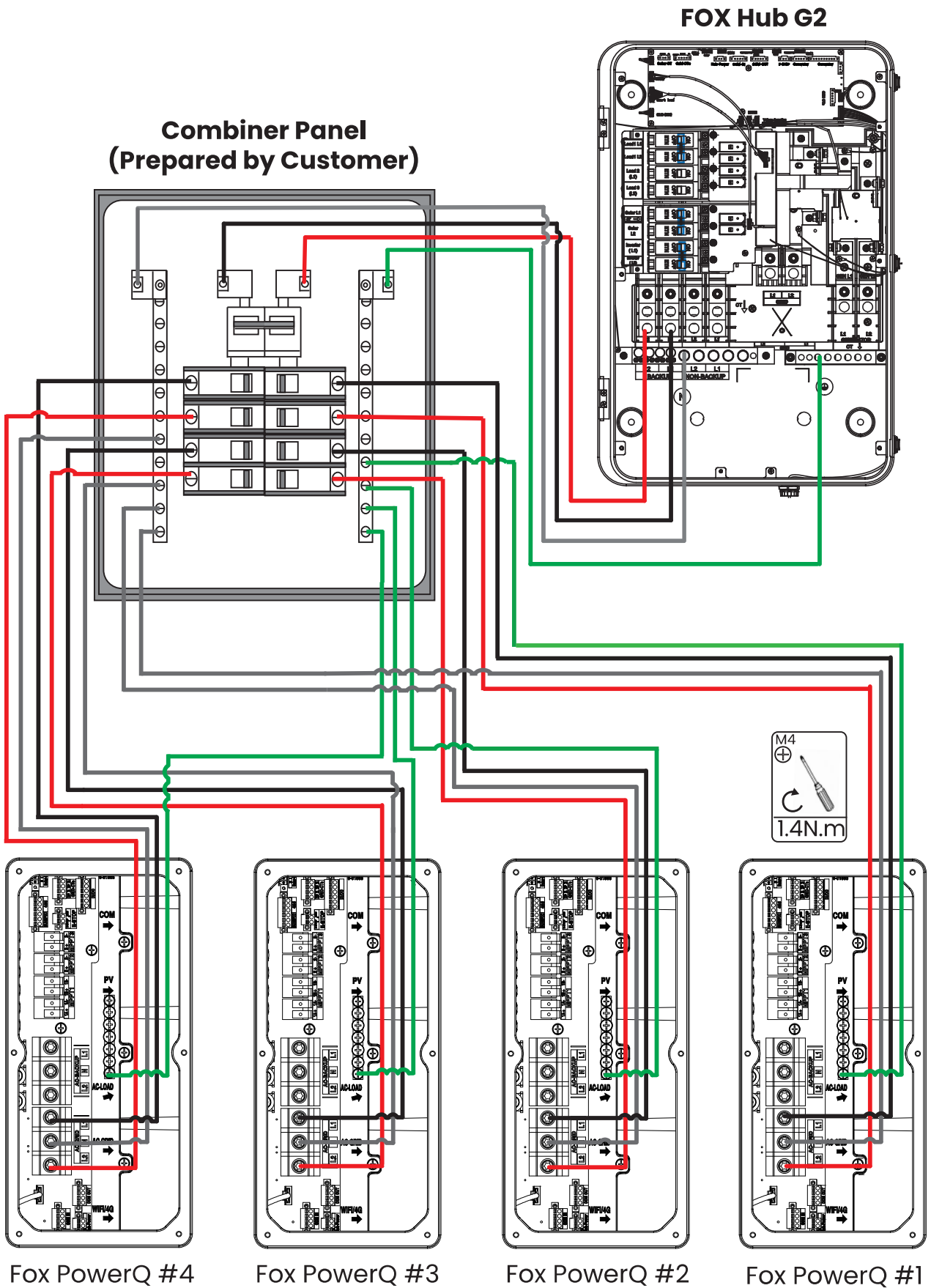

No. of Parellel Fox PowerQ units	Minimum Wire Gauge (Combiner Panel–FOX Hub G2)
2 Fox PowerQ units	2 AWG
3 Fox PowerQ units	2/0 AWG
4 Fox PowerQ units	4/0 AWG

No. of Parellel Fox PowerQ units	Wire Gauge (Combiner Panel–Fox PowerQ Unit)
2 Fox PowerQ units	6 AWG
3 Fox PowerQ units	6 AWG
4 Fox PowerQ units	6 AWG

- The Fox PowerQ Connections to the FOX Hub G2 (Direct)
(2 to 4 Fox PowerQ units)

NOTE:



- ① This connection method is only applicable when no smart load and no third-party inverter are connected on site.
 - ② After connection, users need to set parallel parameters on the App (refer to Page 47 for the setting).
-

L1:
6 AWG 

N:
6 AWG 

L2:
6 AWG 



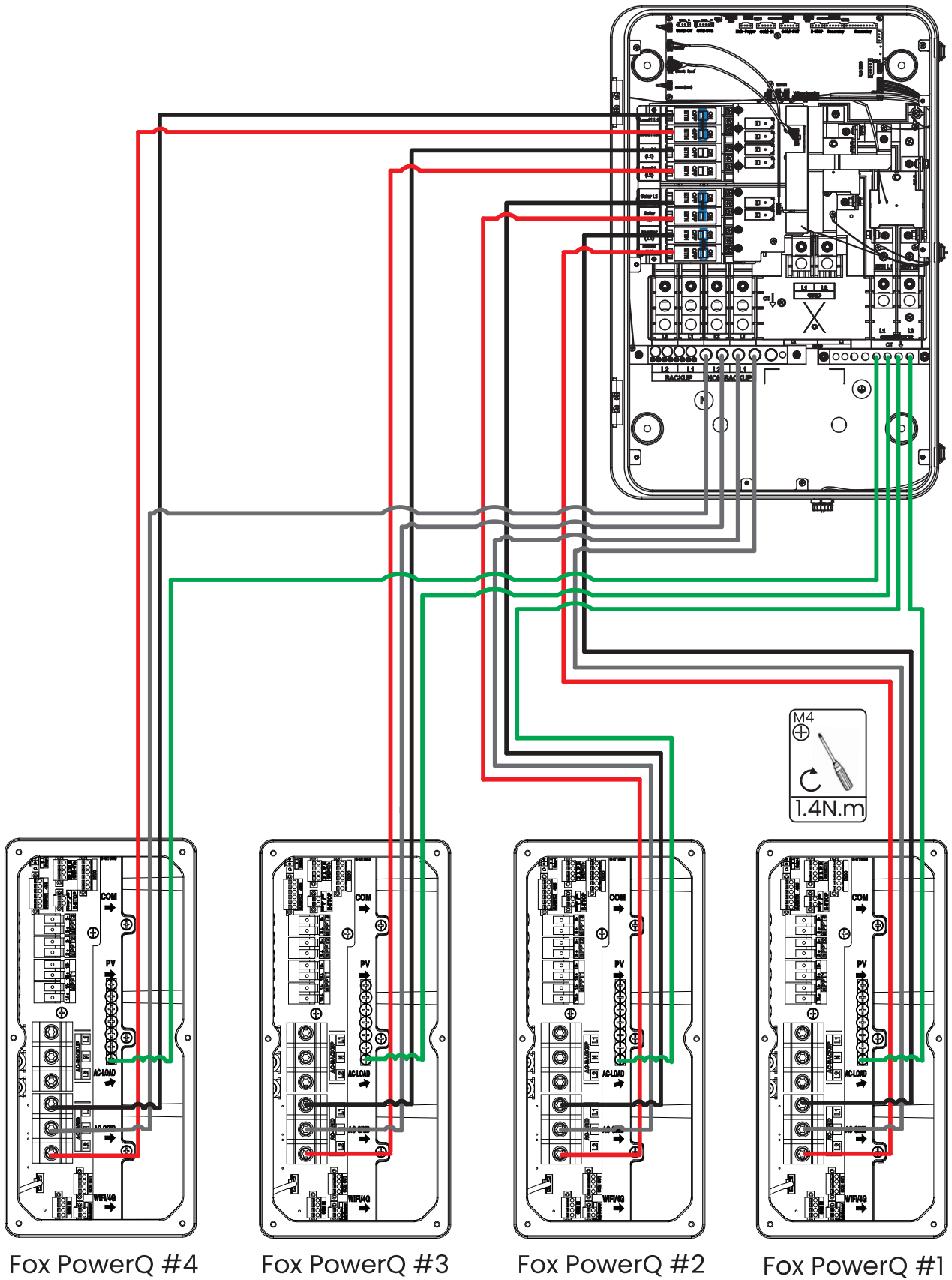

PE:
6 AWG 

FOX Hub G2



- Backup Loads Connections to the FOX Hub G2

FOX Hub G2

- L1:**
6 AWG - 250 kcmil  3/4"
- L2:**
6 AWG - 250 kcmil  3/4"
- N:**
6 AWG - 250 kcmil  3/4"
- PE:**
6 AWG - 2/0 AWG  3/4"

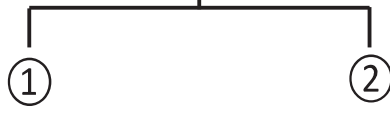
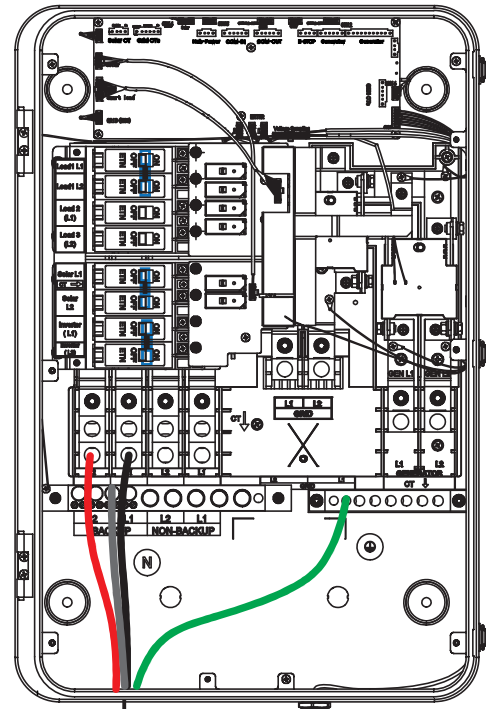

Whole-home Backup Partial-home Backup

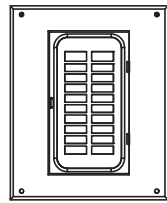

To Main Panel

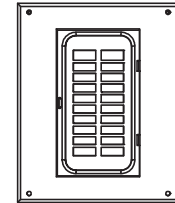

To Subpanel

• Non-backup Loads Connections to the FOX Hub G2

- L1:**
6 AWG - 250 kcmil  3/4"
- L2:**
6 AWG - 250 kcmil  3/4"
- N:**
6 AWG - 250 kcmil  3/4"
- PE:**
6 AWG - 2/0 AWG  3/4"

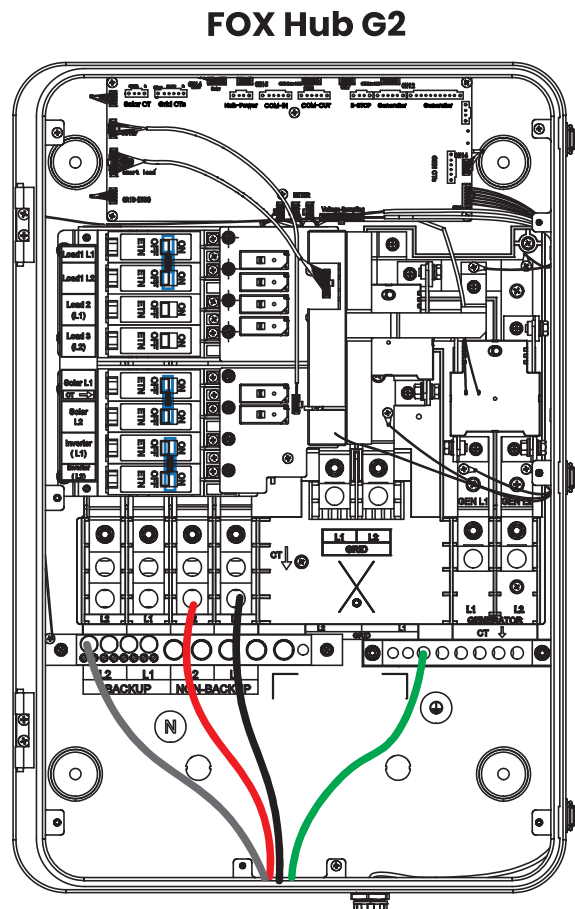

Partial-home Backup

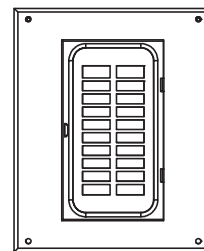

To Main Panel

• The Grid AC Power Connections to the FOX Hub G2

L1:
6 AWG - 4/0 AWG 

L2:
6 AWG - 4/0 AWG 

N:
6 AWG - 4/0 AWG 

L1:
6 AWG - 250 kcmil 

L2:
6 AWG - 250 kcmil 

N:
6 AWG - 250 kcmil 

PE:
6 AWG - 2/0 AWG 

FOX Hub G2

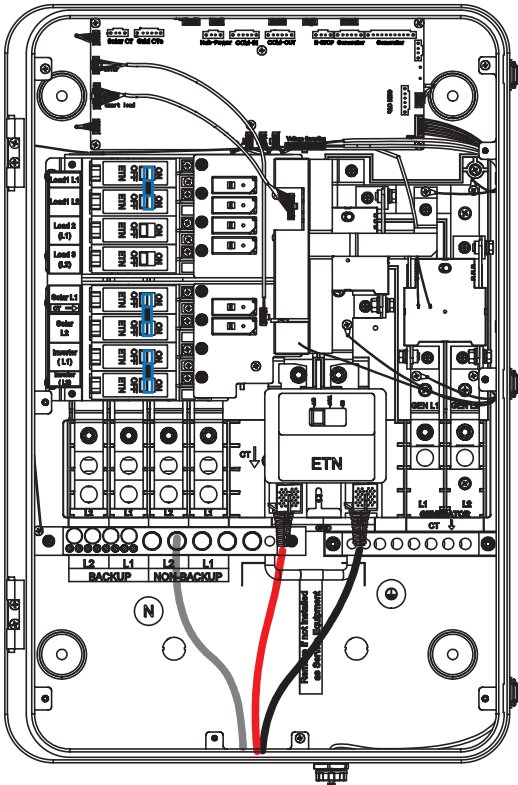

FOX Hub G2 as Service Panel

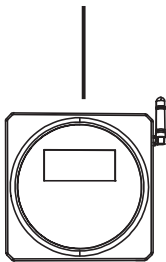

To Utility Meter

FOX Hub G2

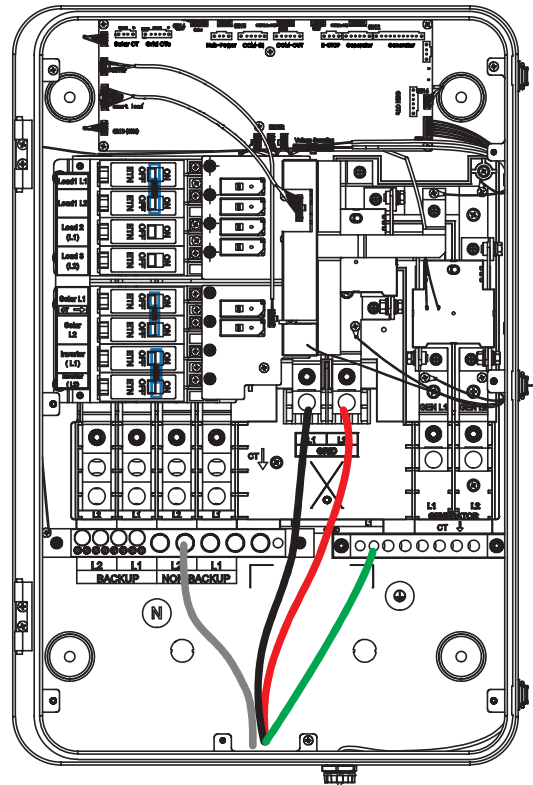

FOX Hub G2 not as Service Panel

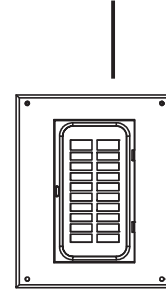

To Main Panel

- The Existing Solar Inverter Connections to the FOX Hub G2 or Main Panel (Optional)

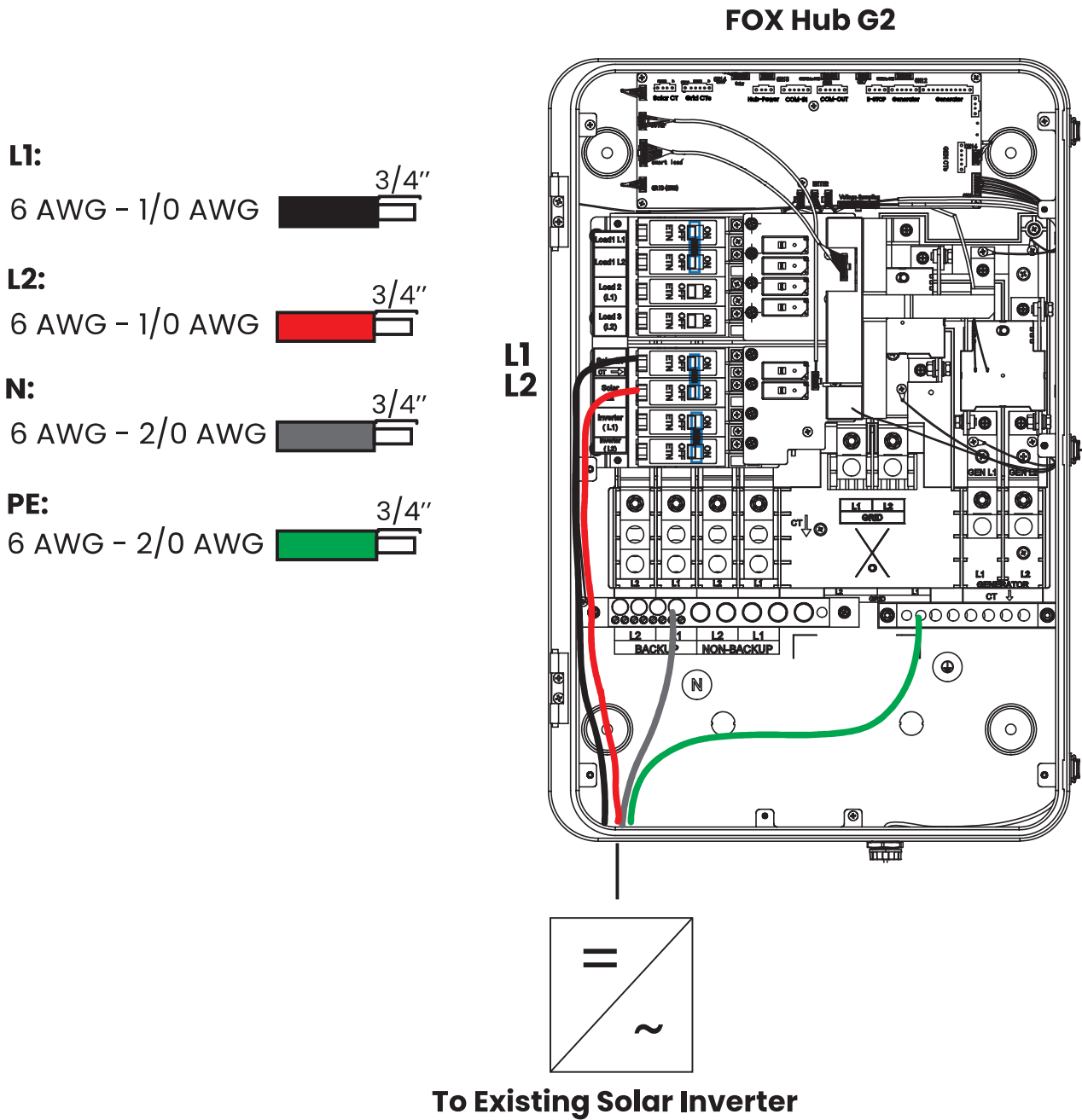

NOTE: The conditions for connecting the existing solar inverter to the main panel are: the system has only one Fox PowerQ, no generator, and the power rating of the existing solar inverter is below the Fox PowerQ's power rating.

• The Smart Loads Connections to the FOX Hub G2 (Optional)

L1:
6 AWG - 1/0 AWG  3/4"

N:
6 AWG - 2/0 AWG  3/4"

L2:
6 AWG - 1/0 AWG  3/4"

PE:
6 AWG - 2/0 AWG  3/4"

FOX Hub G2

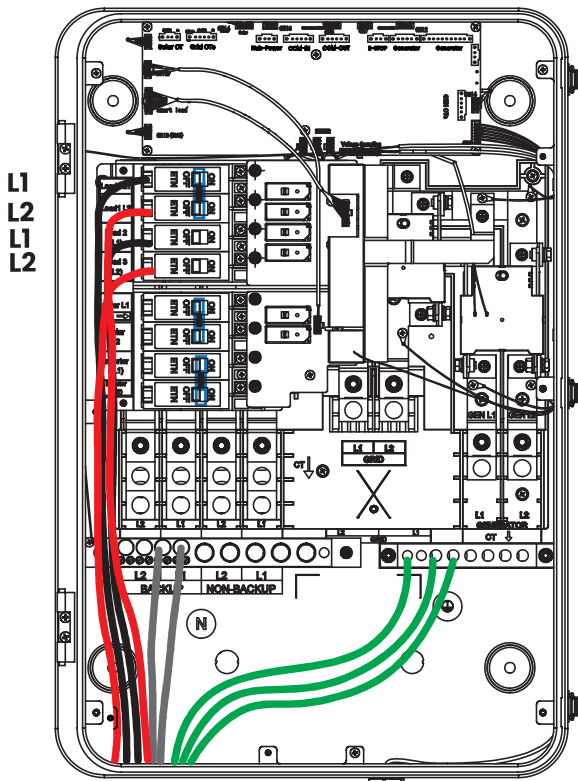

To 3 Smart Loads (240V, 120V, 120V)

FOX Hub G2

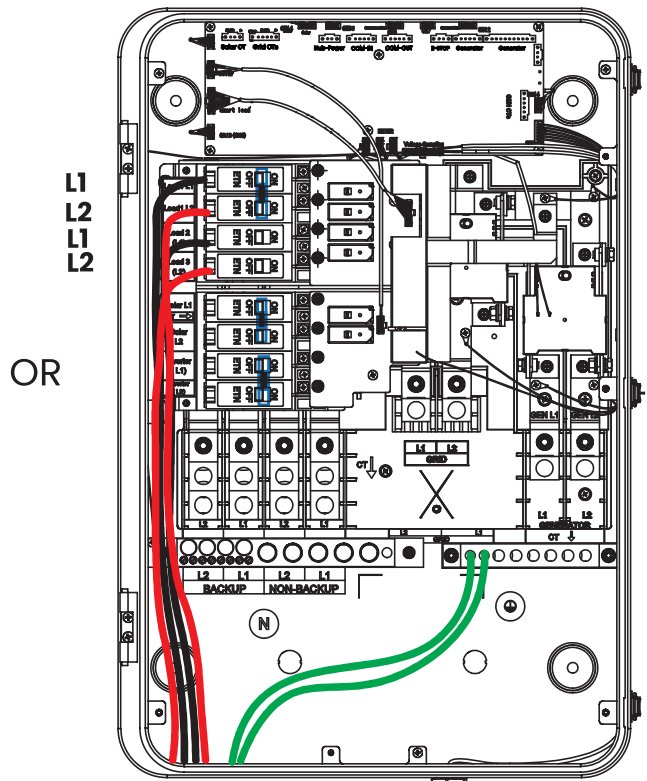

OR



To 2 Smart Loads (240V, 240V)

- The Standby Generator Connections to the FOX Hub G2 (Optional)

- L1:**
6 AWG - 250 kcmil  3/4"
- L2:**
6 AWG - 250 kcmil  3/4"
- N:**
6 AWG - 250 kcmil  3/4"
- PE:**
6 AWG - 2/0 AWG  3/4"

FOX Hub G2

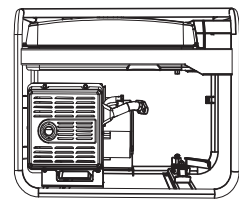
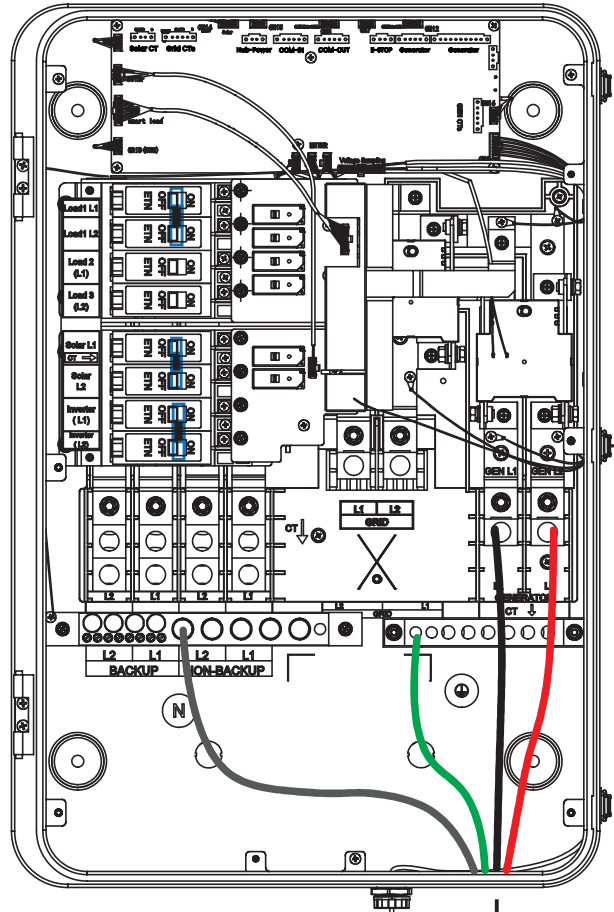

To Standby Generator

5.4 Fox PowerQ Power Cable Wiring

- The PV Panels Connections to the Fox PowerQ

Turn off the DC switch before connection.

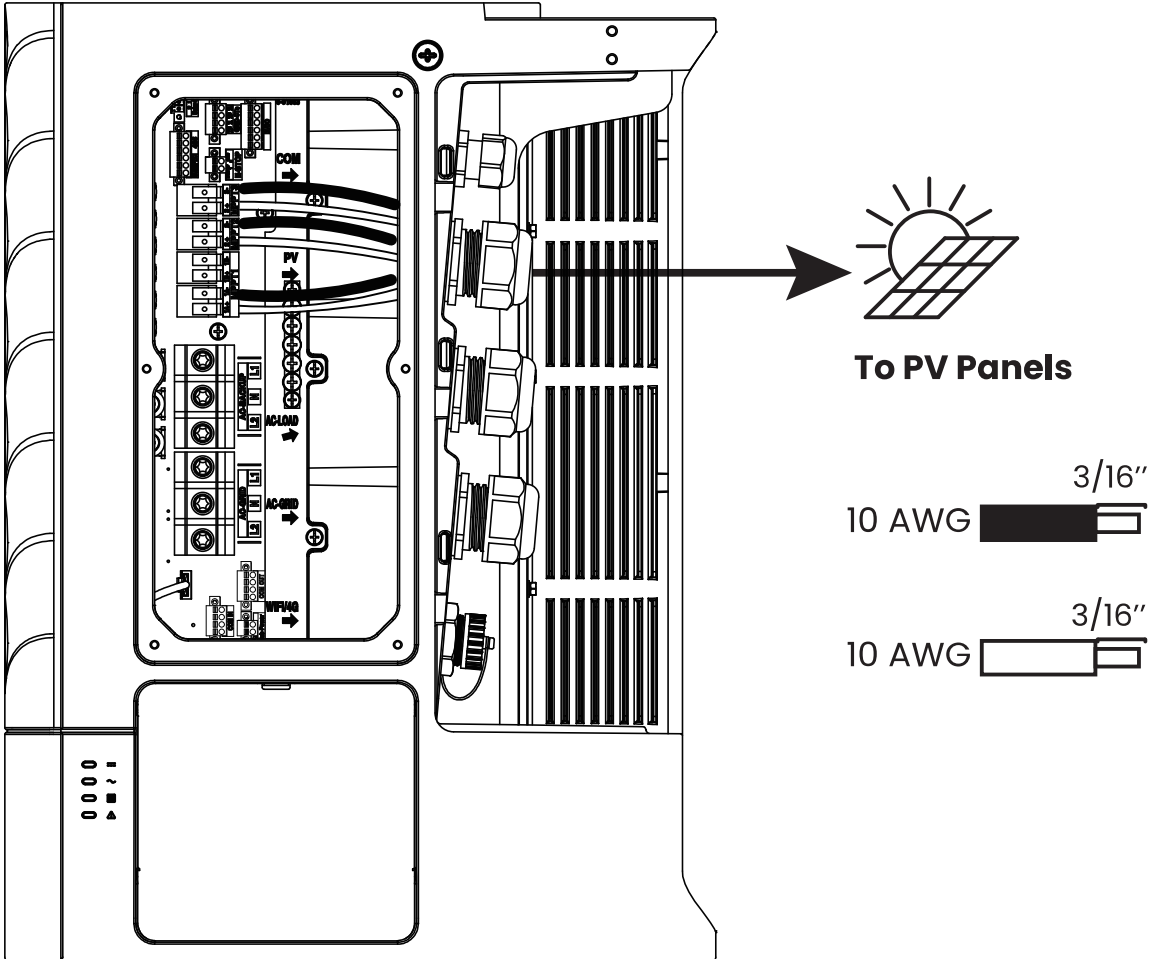

If there are ≤ 3 PV strings, 3 PV strings are preferentially connected to terminals 1A+, 1A-, 2+, 2-, 3+, 3-.

If there are 4 PV strings, the number of PV panels connected to terminals 1A+, 1A- needs to be the same as that connected to terminals 1B+, 1B-.

5.5 FOX Hub G2 Wiring (Communication & Auxiliary Power)

5.5.1 The Fox PowerQ Connections to the FOX Hub G2 (1 to 4 Units)

 16 AWG	 16 AWG
 24-16 AWG	 24-16 AWG
 24-16 AWG	 24-16 AWG

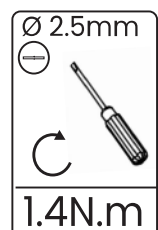

Fox PowerQ #N(N≤4)

Fox PowerQ #2

Fox PowerQ #1

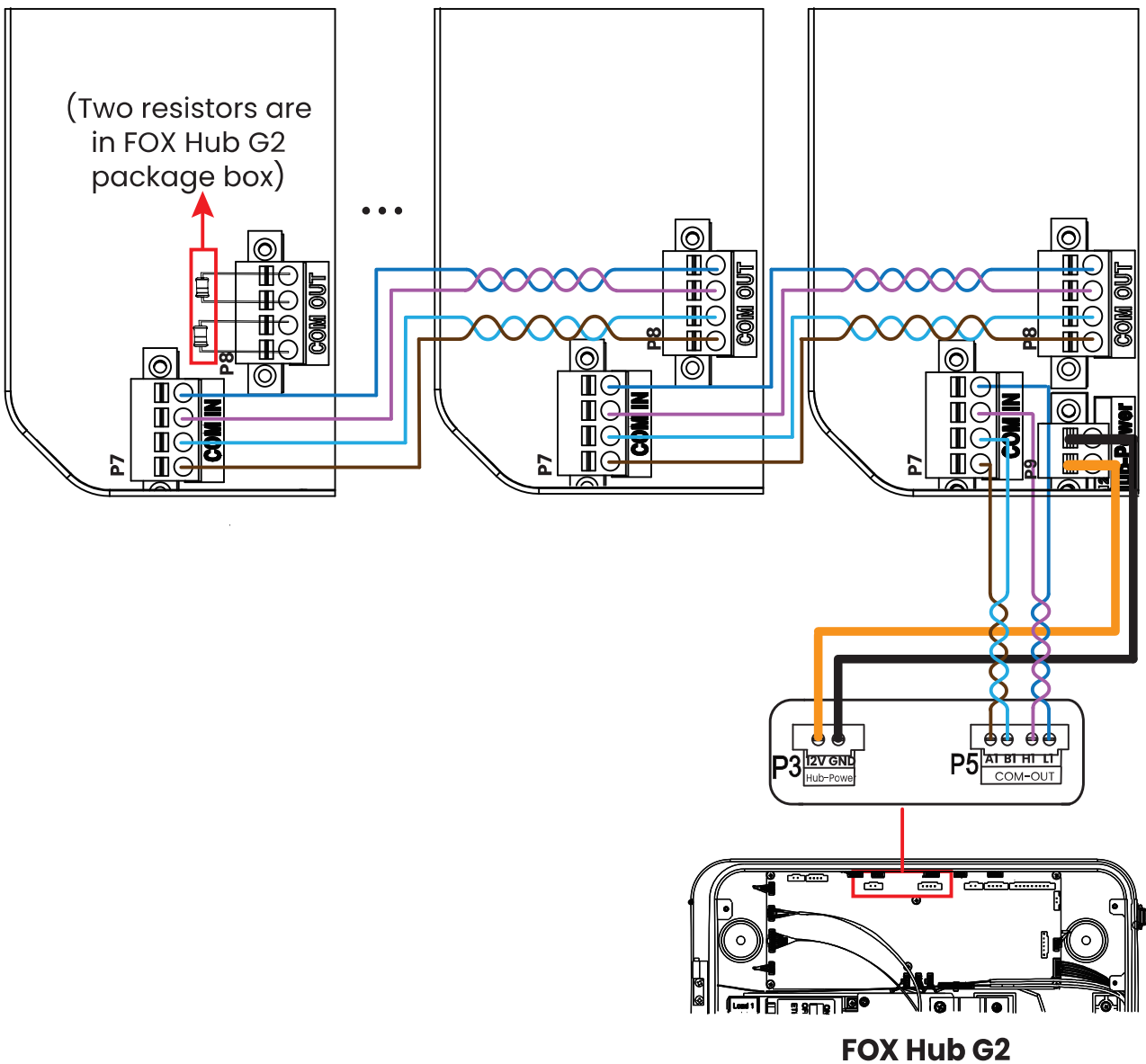

NOTE:



- ① In the last Fox PowerQ in the communication chain, plug the 4-pin P5 socket with two terminating 60Ω resistors.
- ② The twisted cables use shielded twisted pair with drain wire (minimum CAT5e network cable).
- ③ The maximum cable lengths between FOX Hub G2 and Fox PowerQ #1, and between Fox PowerQ units are 50m and 5m, respectively.

5.5.2 The FOX Hub G2 Connections to the Standby Generator (Optional)

Caution: it is essential to disconnect the DC and AC before wiring. Please be cautious.

5.5.2.1 Control Type: Utility Voltage Sense

Take Guardian series standby generator as an example.

 16 AWG  24-16 AWG

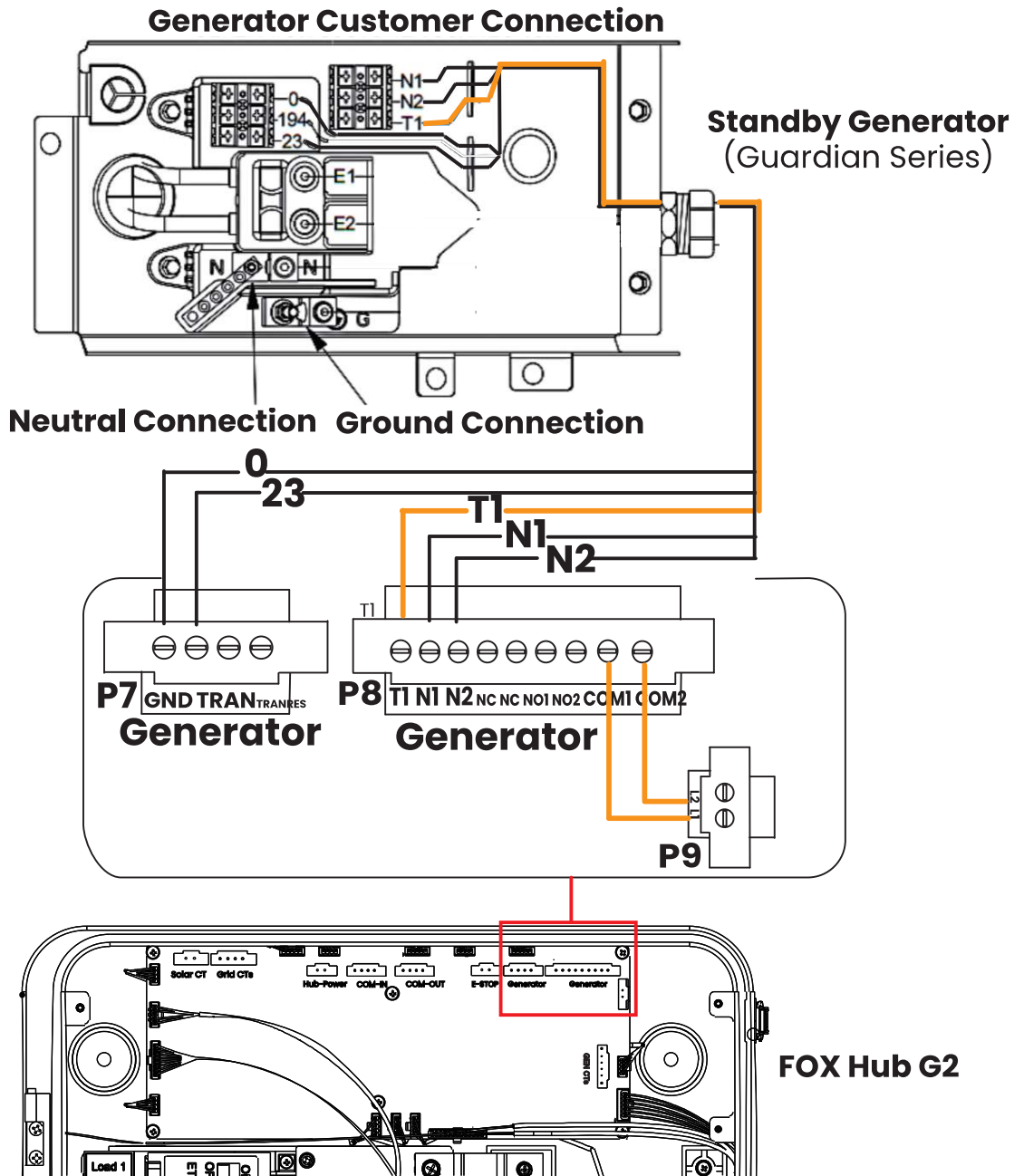

5.5.2.2 Control Type: Dry Contact

① Dry contact normally open generator

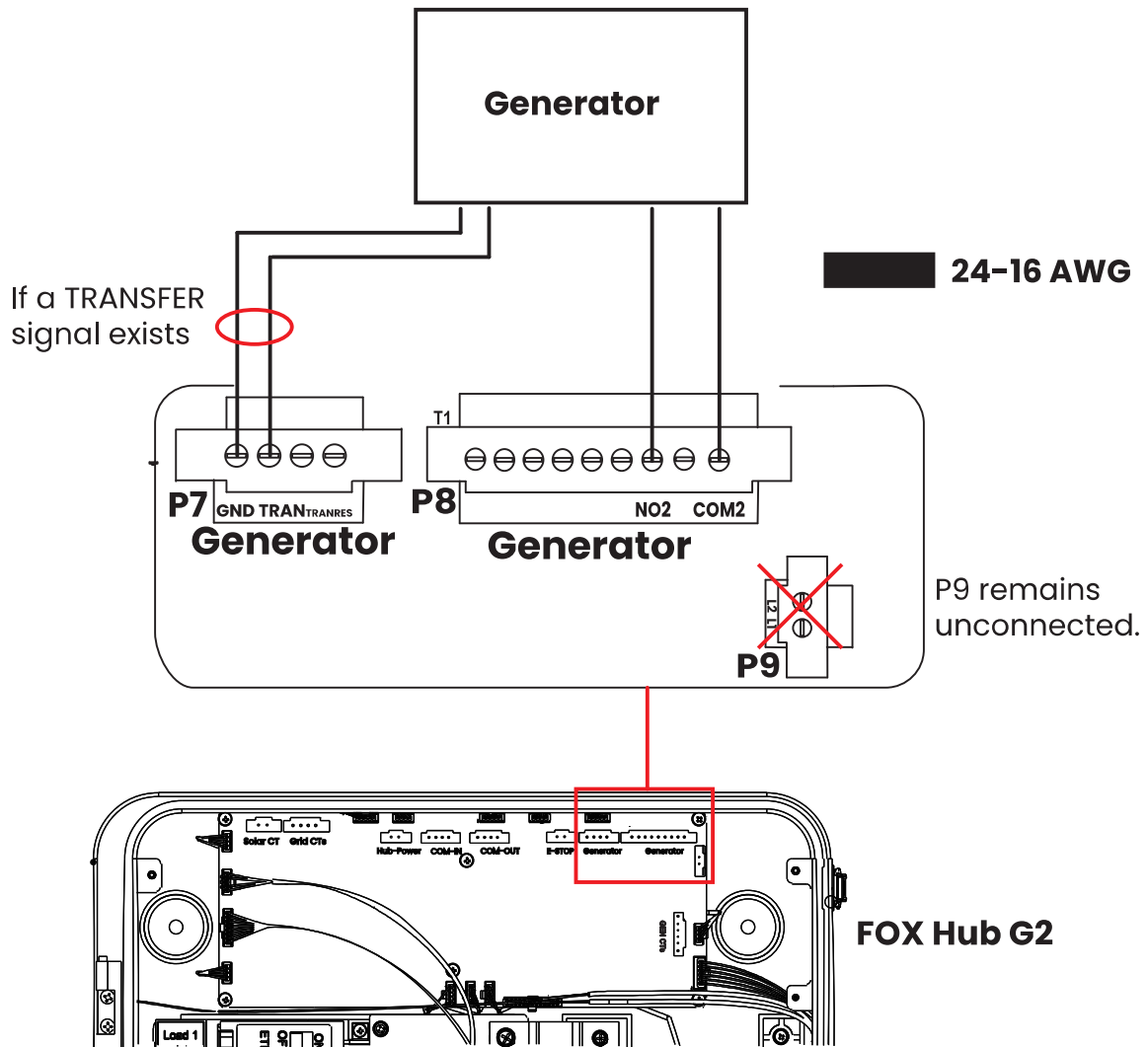

② Dry contact normally closed generator

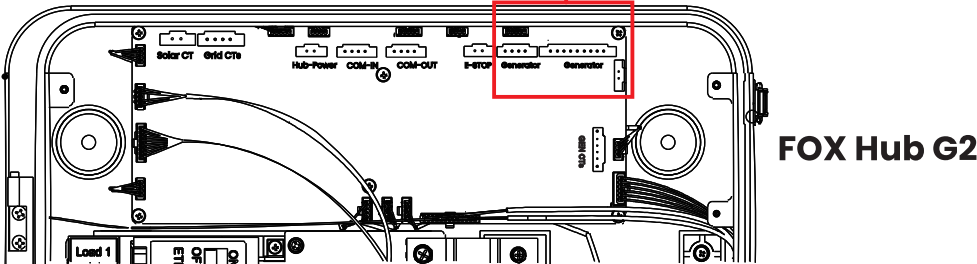
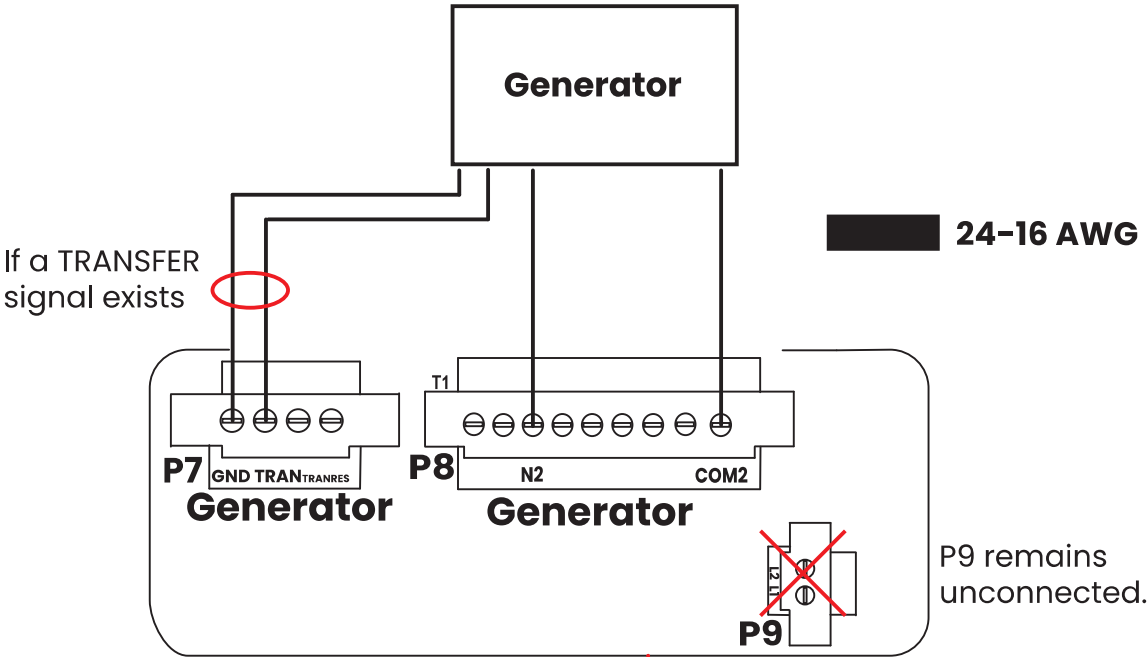

③ If the generator's battery needs our system to charge it,

- Providing 120 VAC

FOX Hub G2

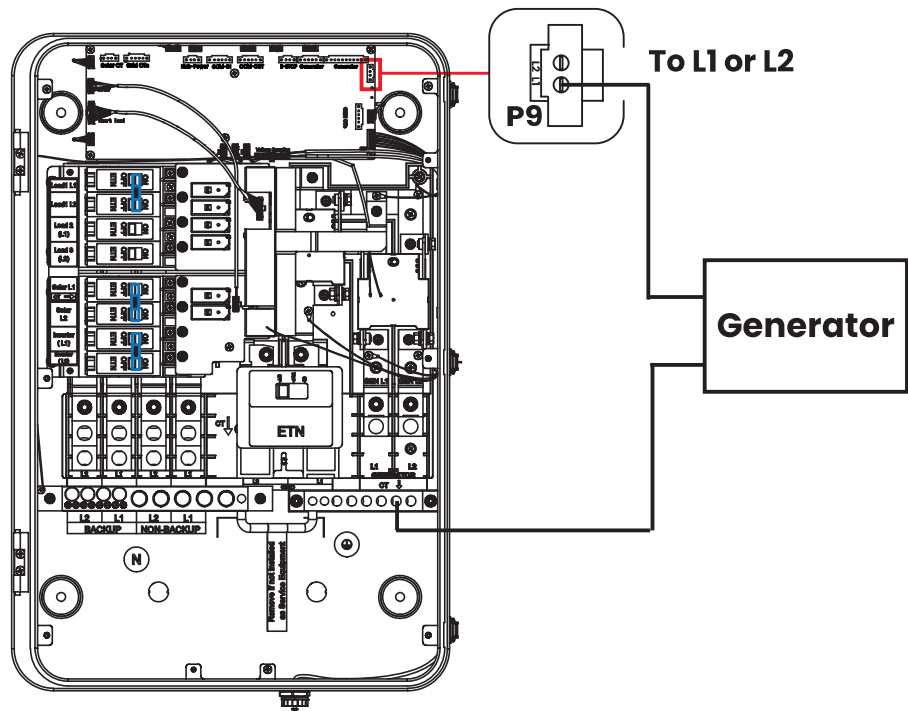

- Providing 240 VAC

FOX Hub G2

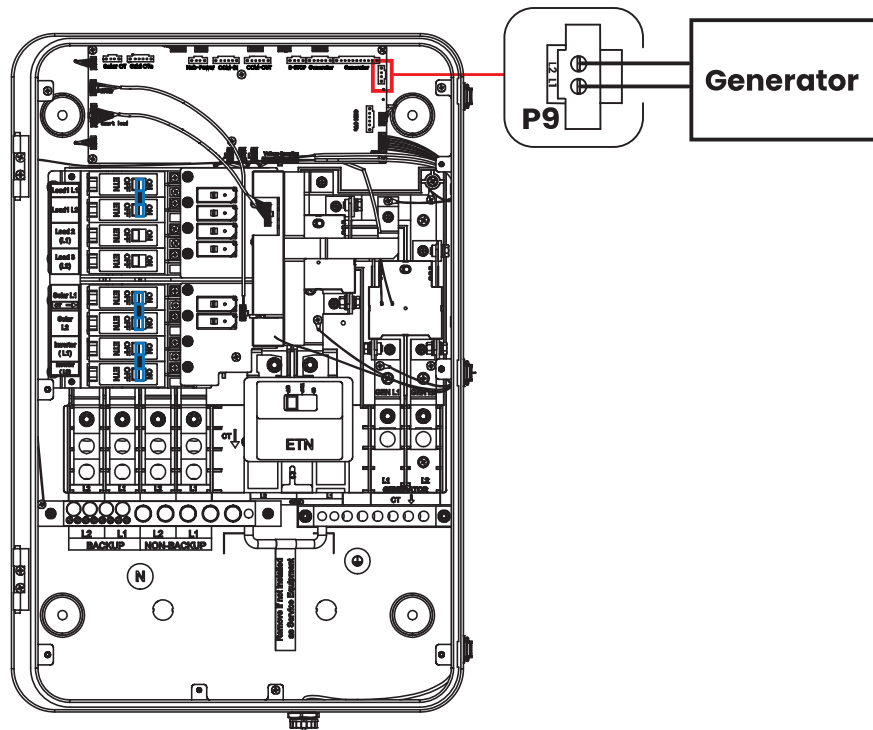

5.6 CT Wiring

- Solar CT Wiring (Only for AC Couple)

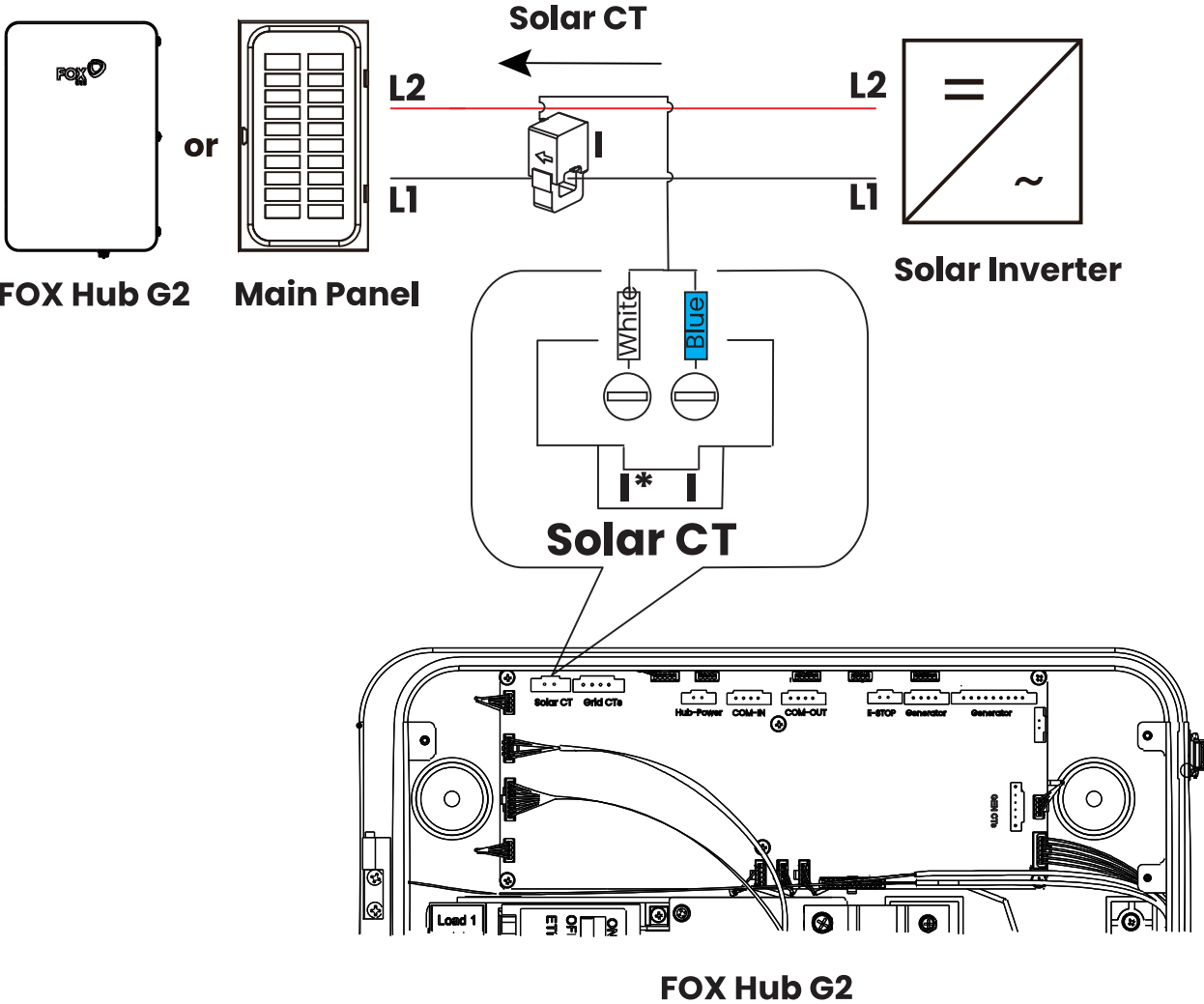

• GEN CTs Wiring (Optional)

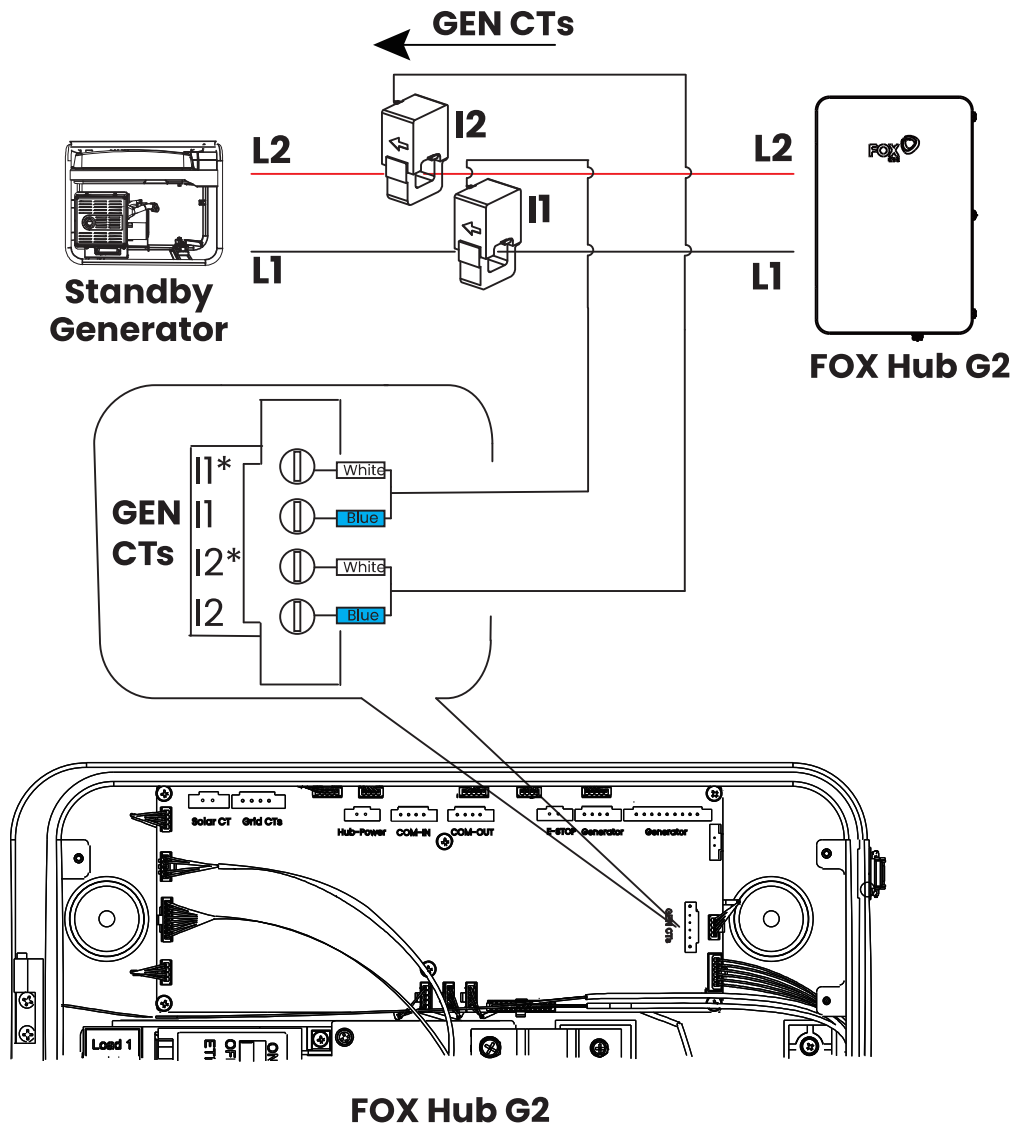

• Grid CTs Wiring

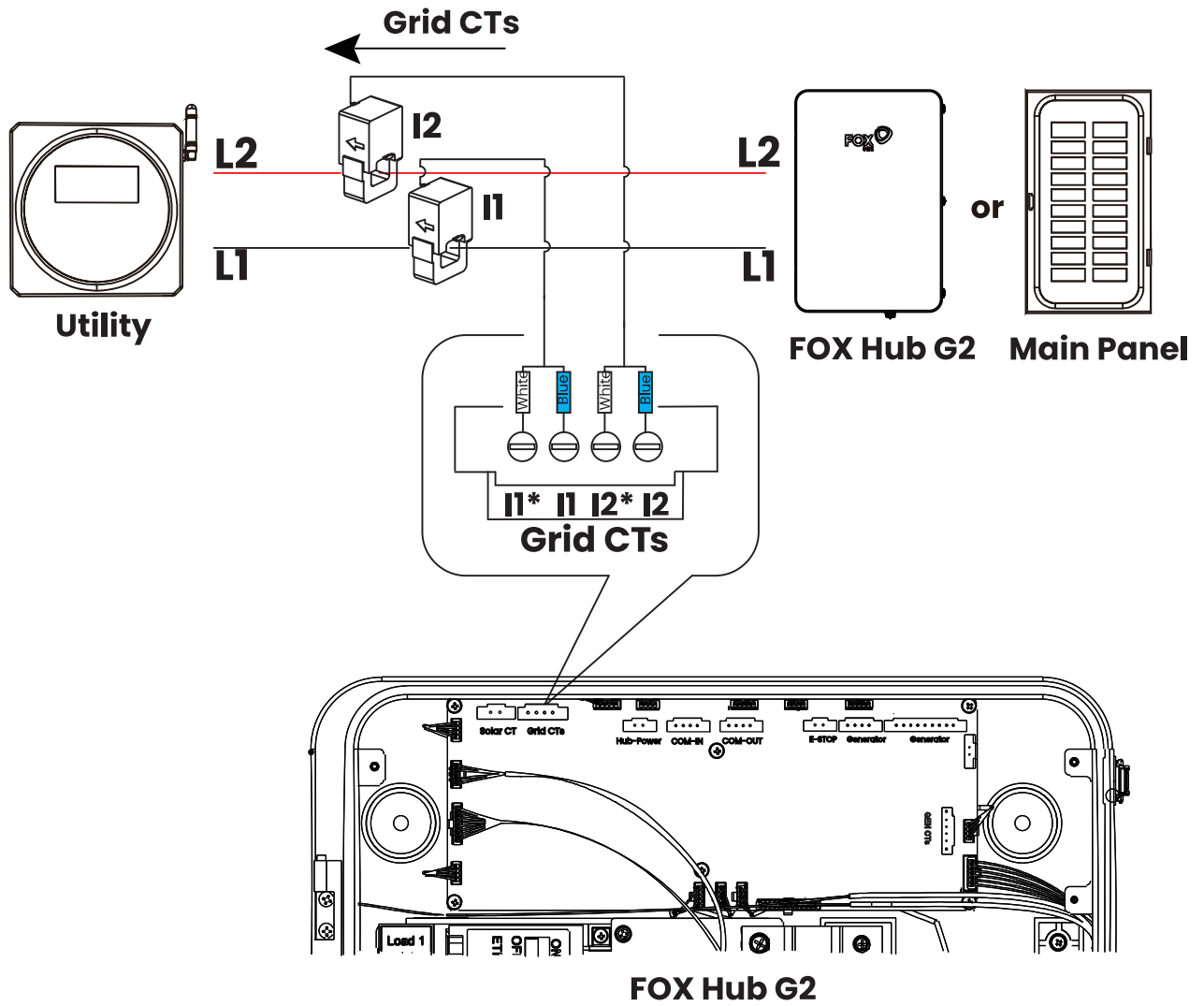

5.7 E-STOP Wiring

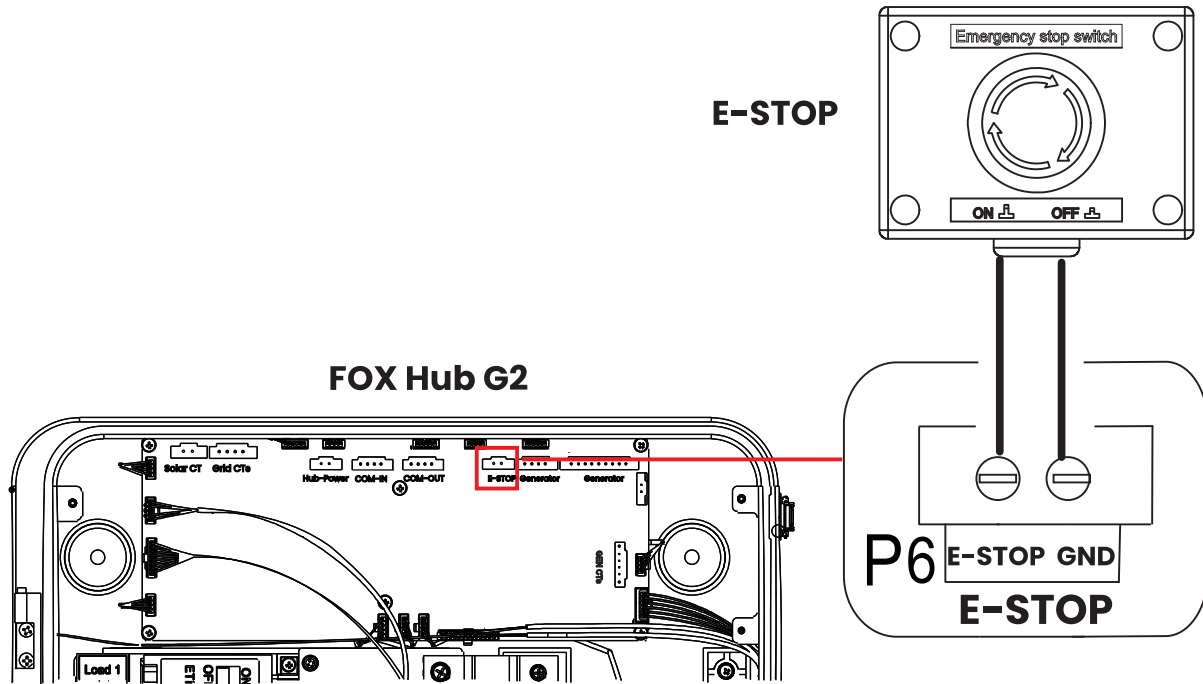

Step 1: remove the jumper on the P6 socket of the **FOX Hub G2**.

Step 2: connect the pins 1 and 2 of the P6 to the E-STOP.

5.8 Smart WiLAN & Smart 4GWiLAN Connection

- WiFi & 4G Installation: connect the Smart WiLAN or the Smart 4GWiLAN to the **FOX Hub G2**.

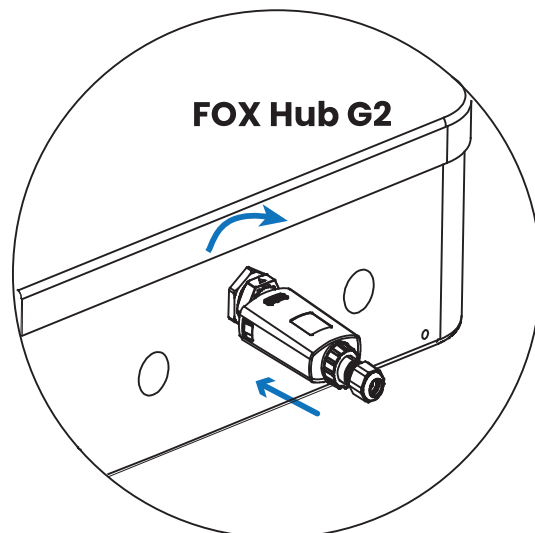

- LAN Installation: insert the network cable into the Smart WiLAN or the Smart 4GWiLAN, and connect it to the FOX Hub G2.

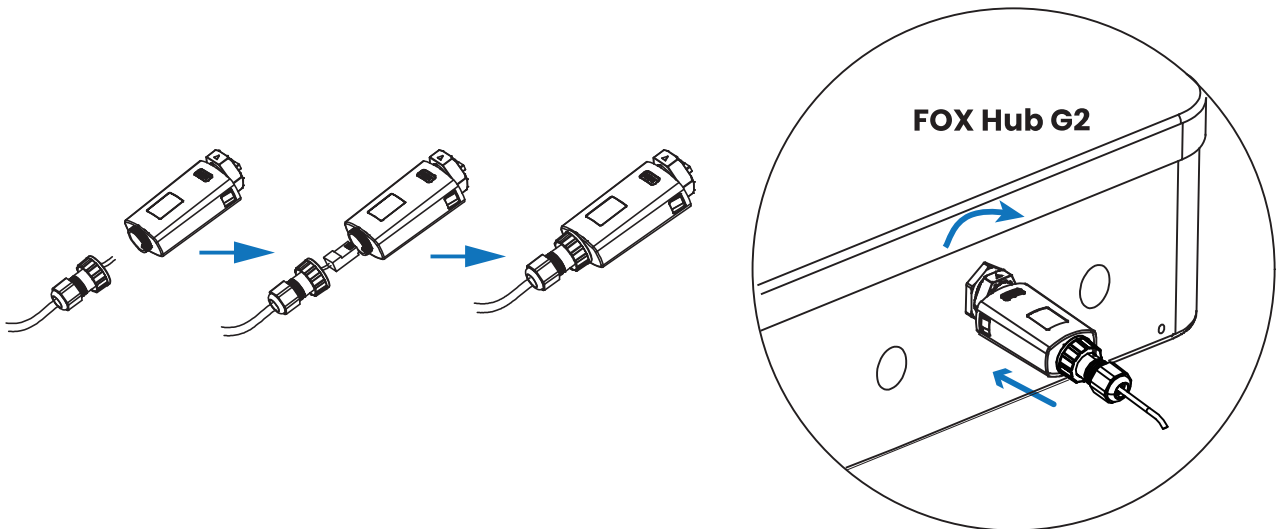

6 System Startup

Please refer to the following steps to switch on the system.

1. Ensure all cables are connected properly.
2. Turn on the PV SWITCH on the Fox PowerQ (Only for New System), and AC breakers (in main panel or service panel).
3. Turn on "BAT SWITCH" first, then press and hold "BAT POWER" button for 3s, and then release it.
4. Check if green lights on the Fox PowerQ are solid on.

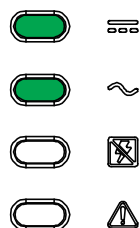
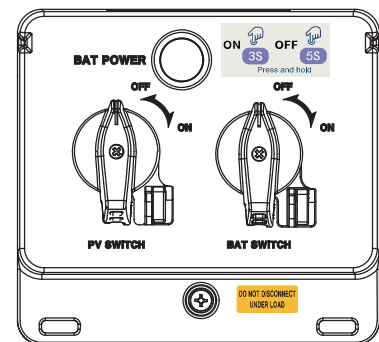

In case you need to turn off the system, please refer to the following steps:

1. Turn off the PV SWITCH, press and hold "BAT POWER" for 5s, and turn off "BAT SWITCH" and AC breakers.
2. Wait for 5 minutes before you open the side cover of the Fox PowerQ (in case of repair).

Step 1: scan the QR code to download FoxCloud2.0 app and download the app.

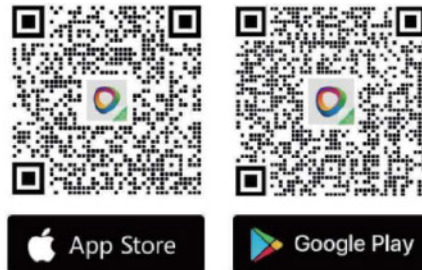

After the app is installed, the FoxCloud2.0 icon is displayed on the home screen.



FoxCloud2.0

Step 2: Initial App Configuration (**First Download Only**)

- Tap "**Getting Started**", select "**North America**".

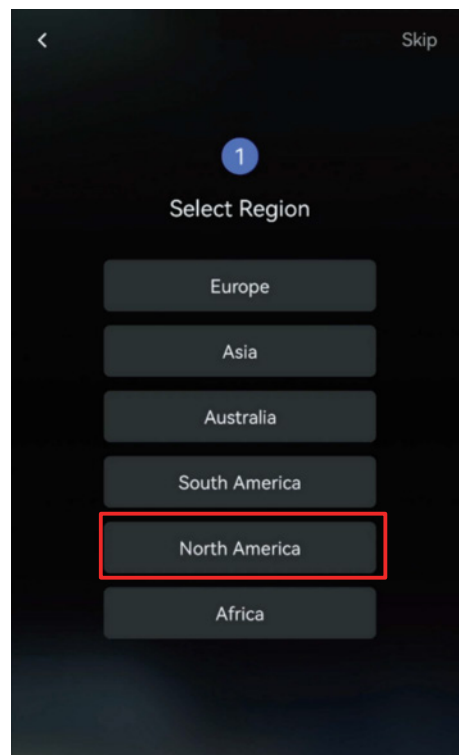
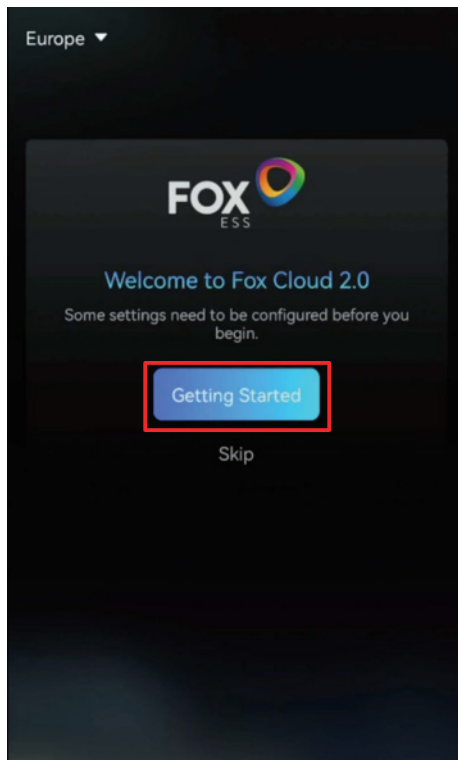

- Create an account.
For installers/distributors

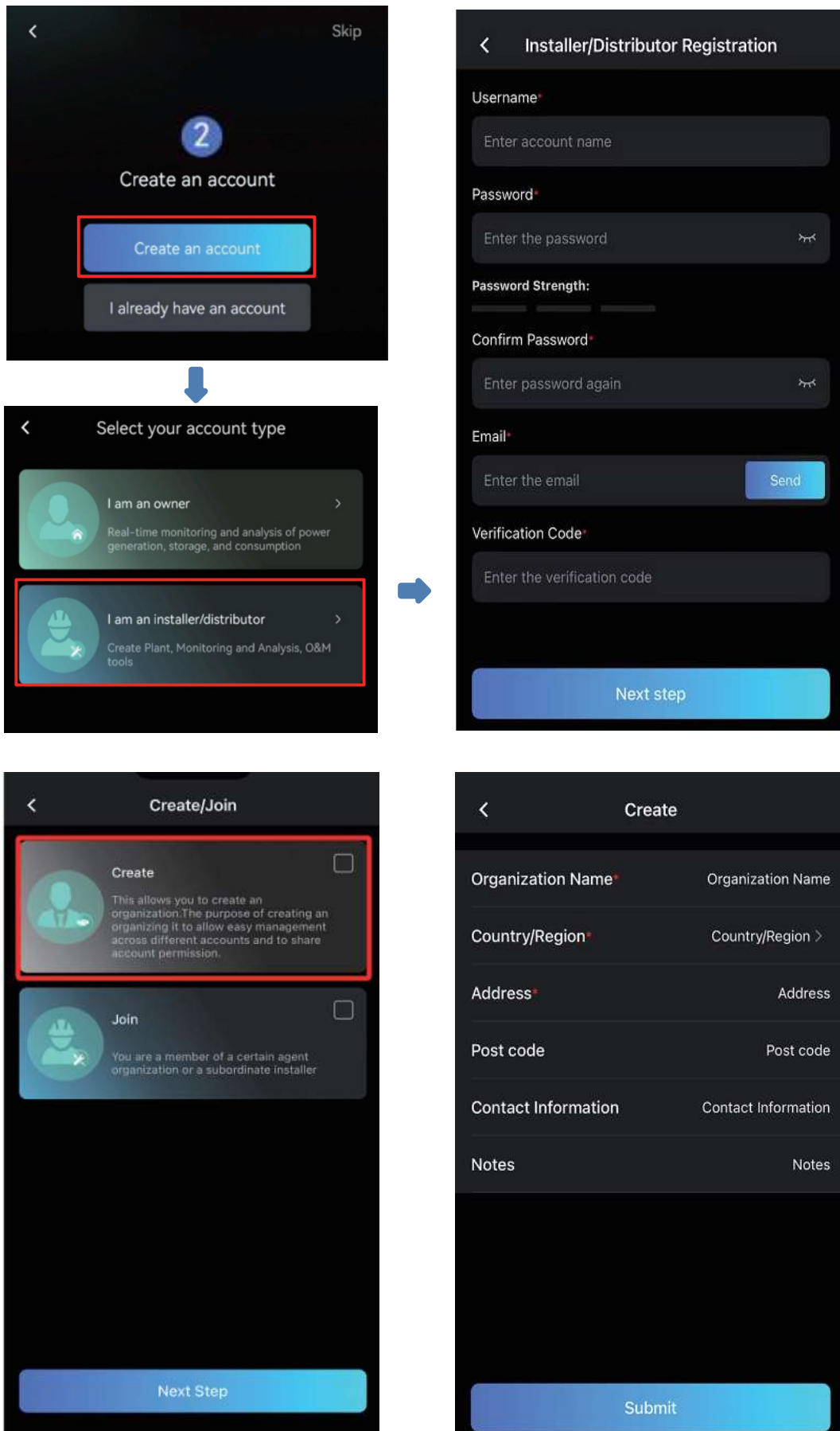

- Connect to the network. Turn on the Bluetooth of your phone in advance.

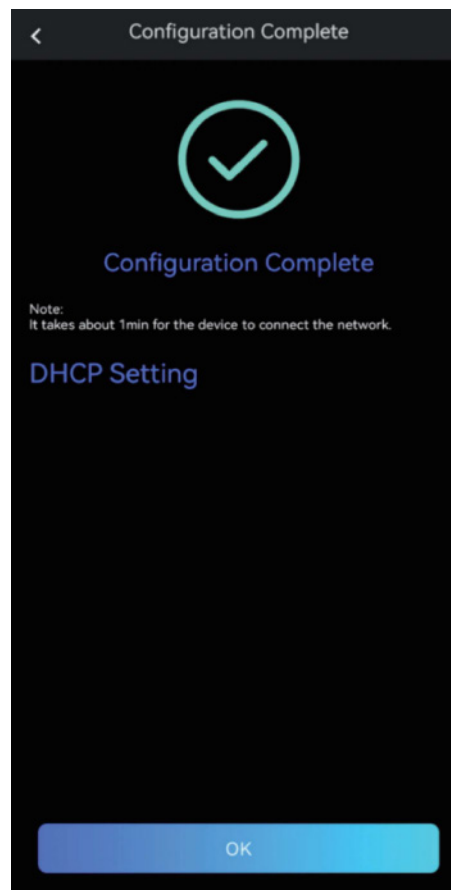
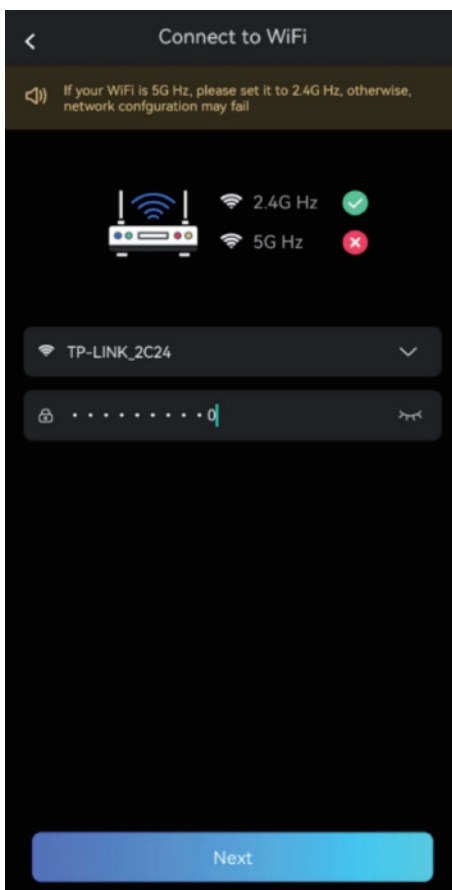
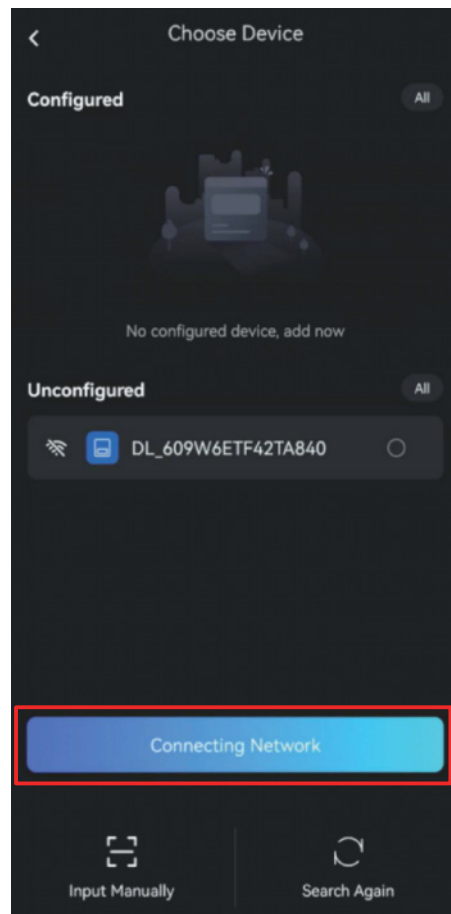
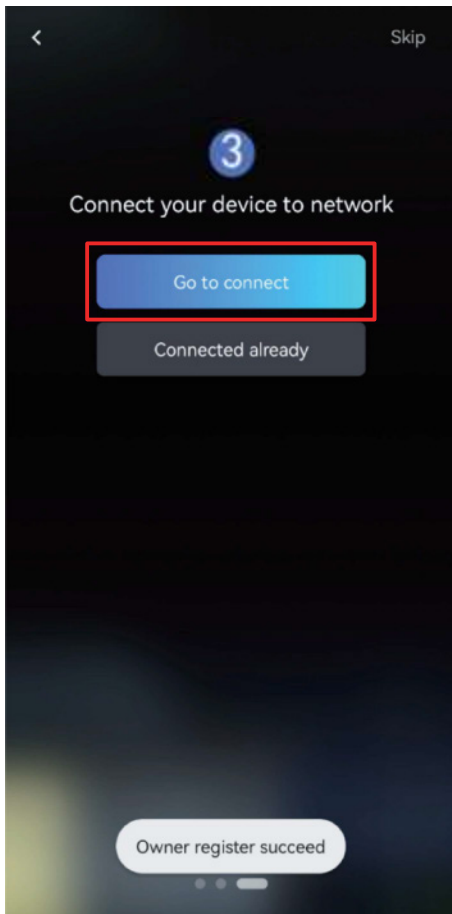

Step 3: Tap “...” at the right corner, select “WLAN Configuration”.

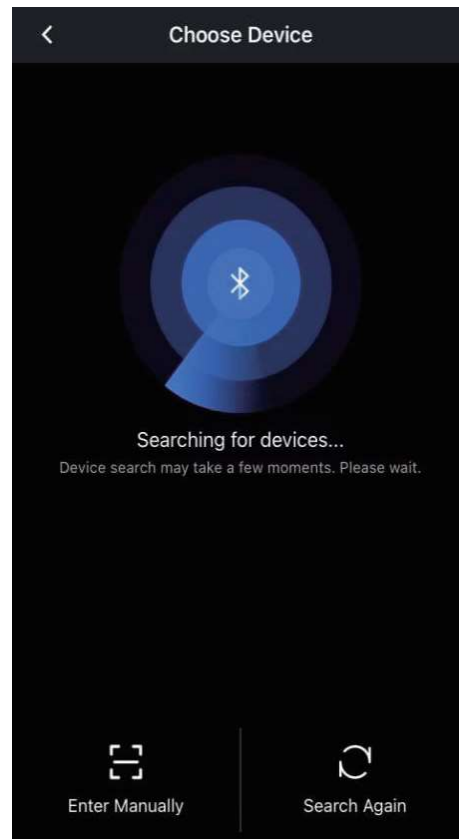

Or, manually enter the SN code on the Smart WiLAN.

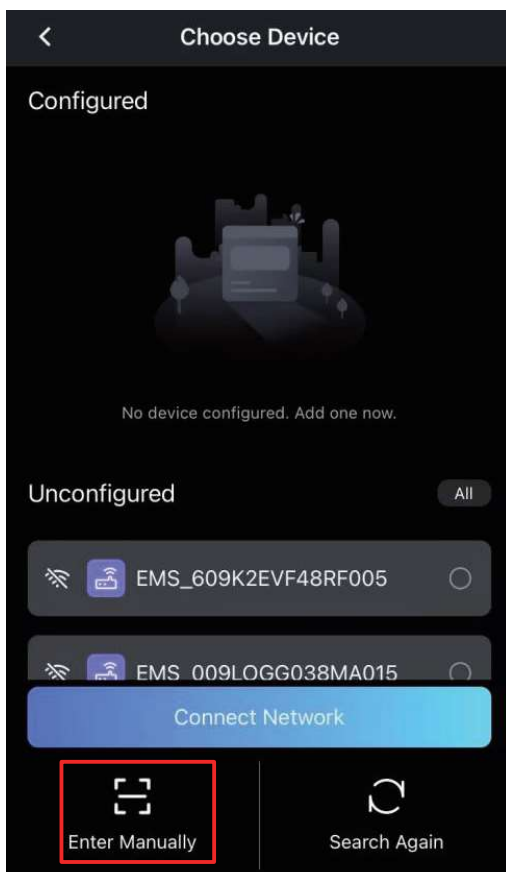

Light indication on the Smart WiLAN

Indicator	Status	Instructions
Red light	Blinking	Not connected to the server
	Solid on	Connected to the server
Green light	Blinking	Data transmission

Step 4: Sign in the installer's account. Tap **"Create a plant"**.

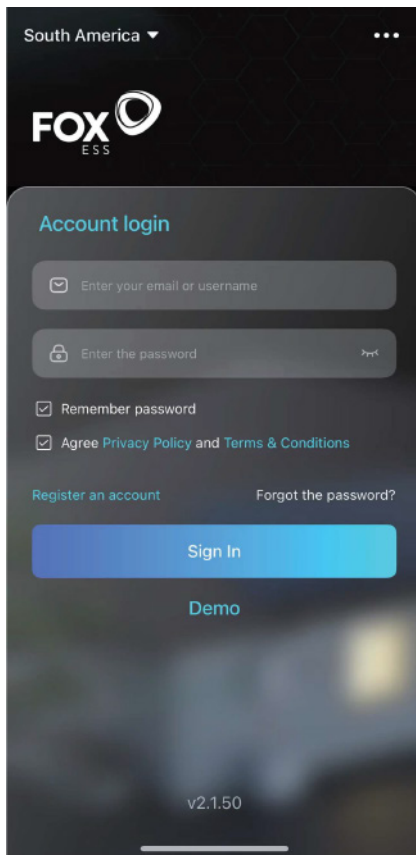

Scan the QR code on the Smart WiLAN or enter the SN code, and fill the information.

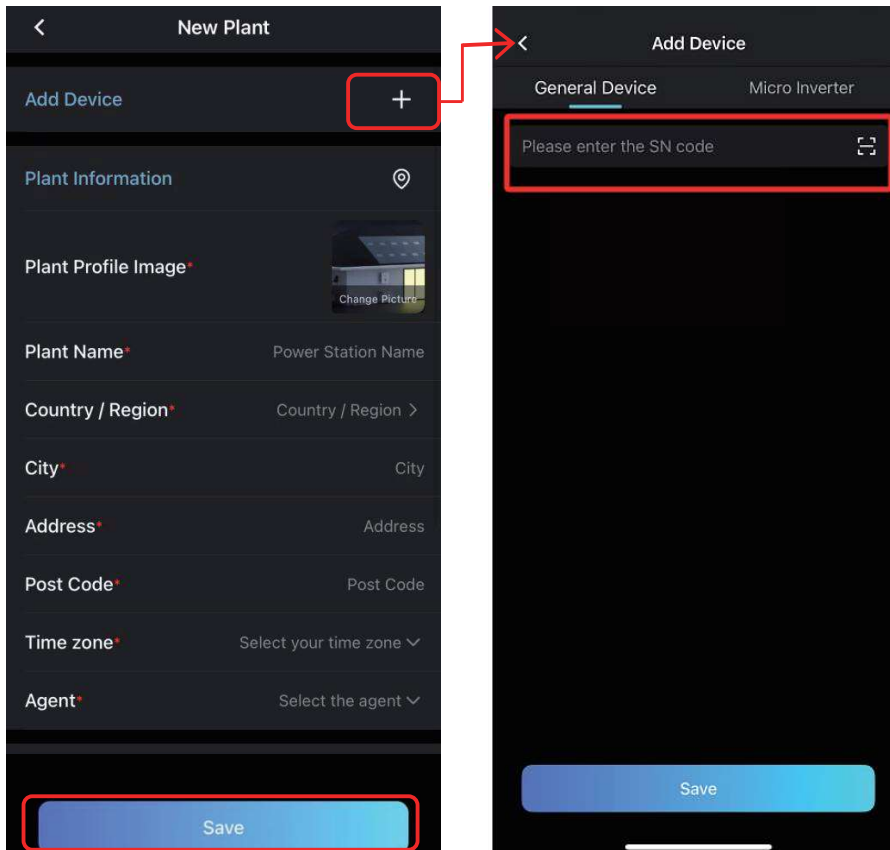

Step 5: Check system performance on "Plant" dashboard.

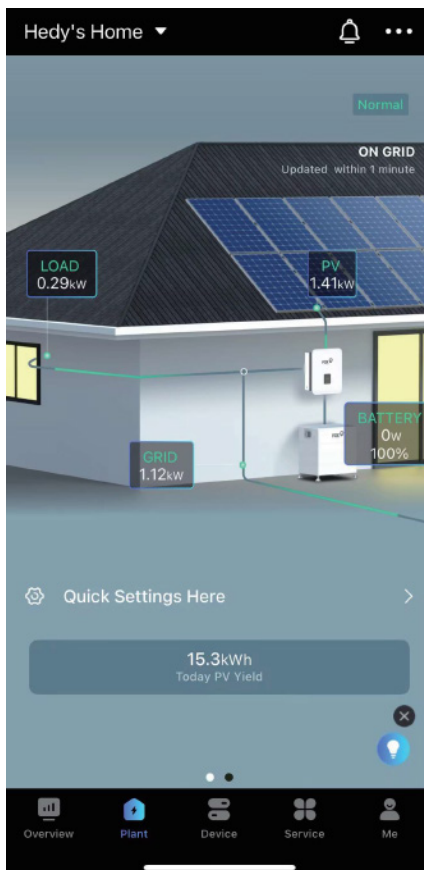

Step 6: Use the checklist below to make sure the necessary items are completed.

Item	Necessary or Optional	Status (✓ if completed)
1. Time Zone	Necessary	
2. Energy Mode	Necessary	
3. Zero Back-feed	Optional	
4. Service Panel Parameter	Optional (Only needed when the FOX Hub G2 is not used as a service panel)	
5. Grid Code	Optional (Only needed when selling to countries except US; Change "USA" into your own country)	
6. Existing Solar Inverter Power	Optional (Only needed in Existing System)	
7. Charge from Grid	Optional (Only needed when main breaker cannot support inverter output during full load)	
8. Parallel Parameter	Optional	

Item 1: Set up the time zone on the "Plant" dashboard.

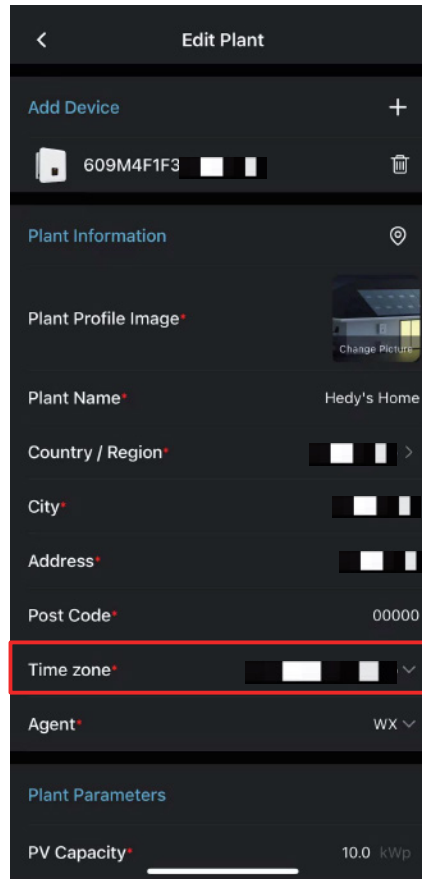
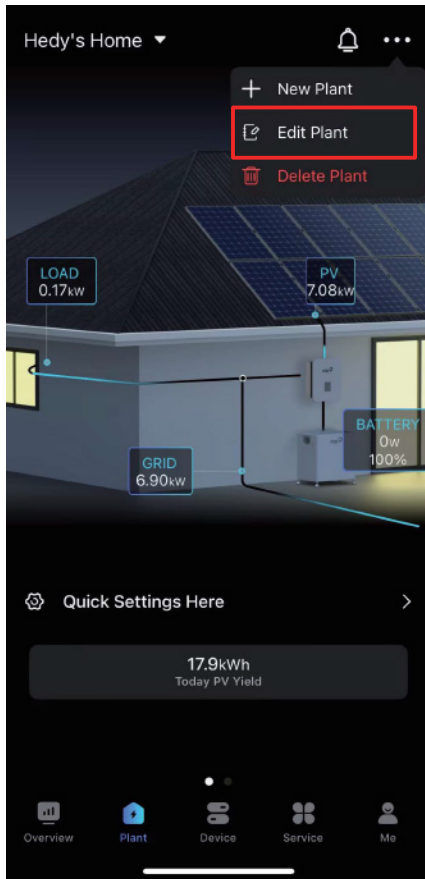

Item 2: Configure the energy management mode on the "Plant" dashboard.

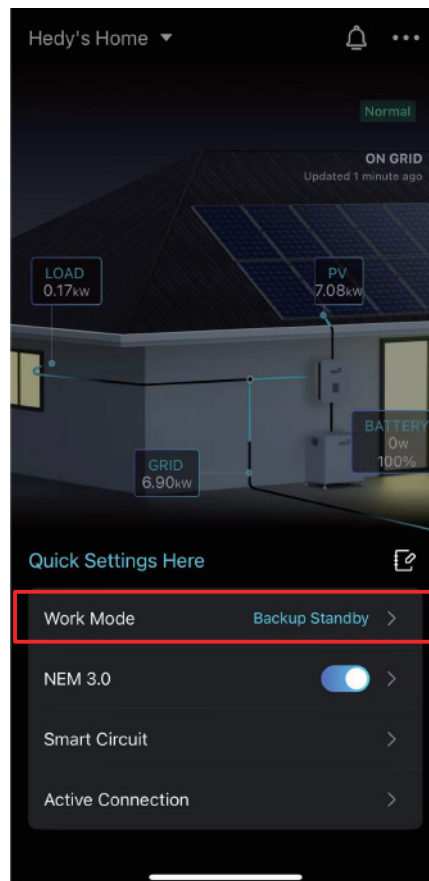
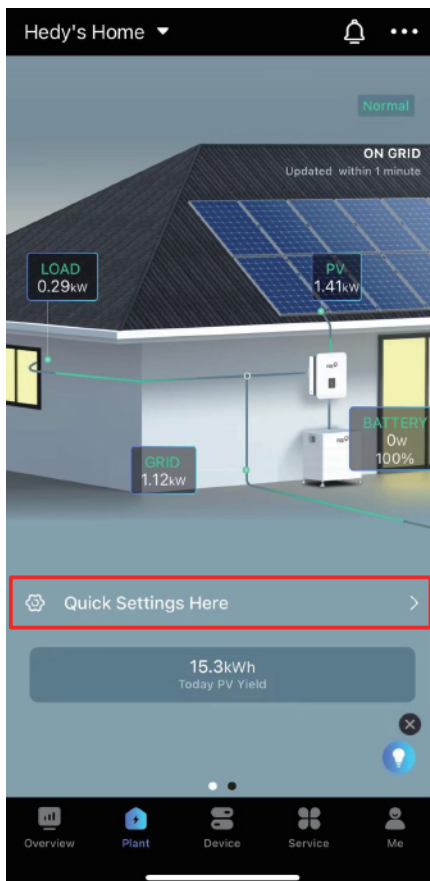

Item 3: Set the zero back-feed on the **“Device”** dashboard.

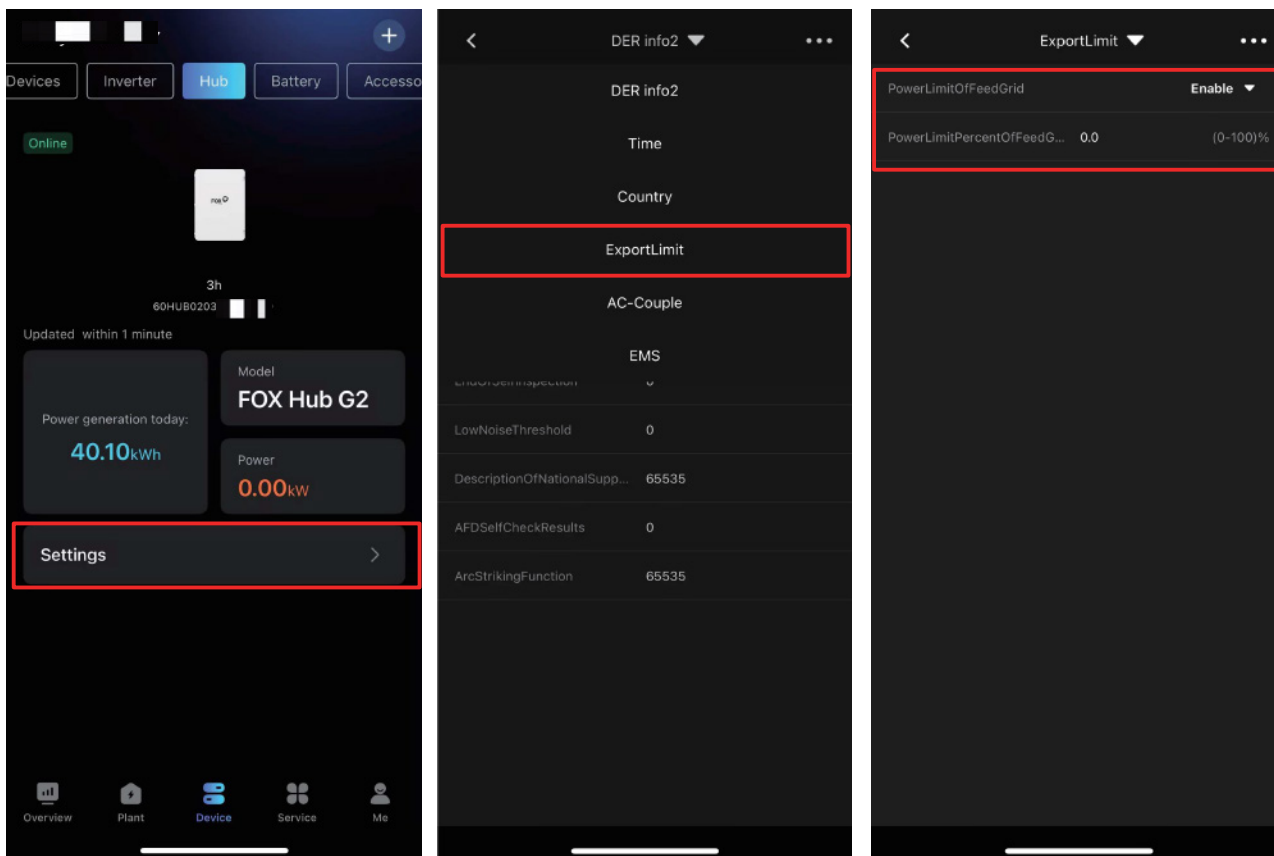

Item 4: Set service panel parameters on the **“Device”** dashboard.

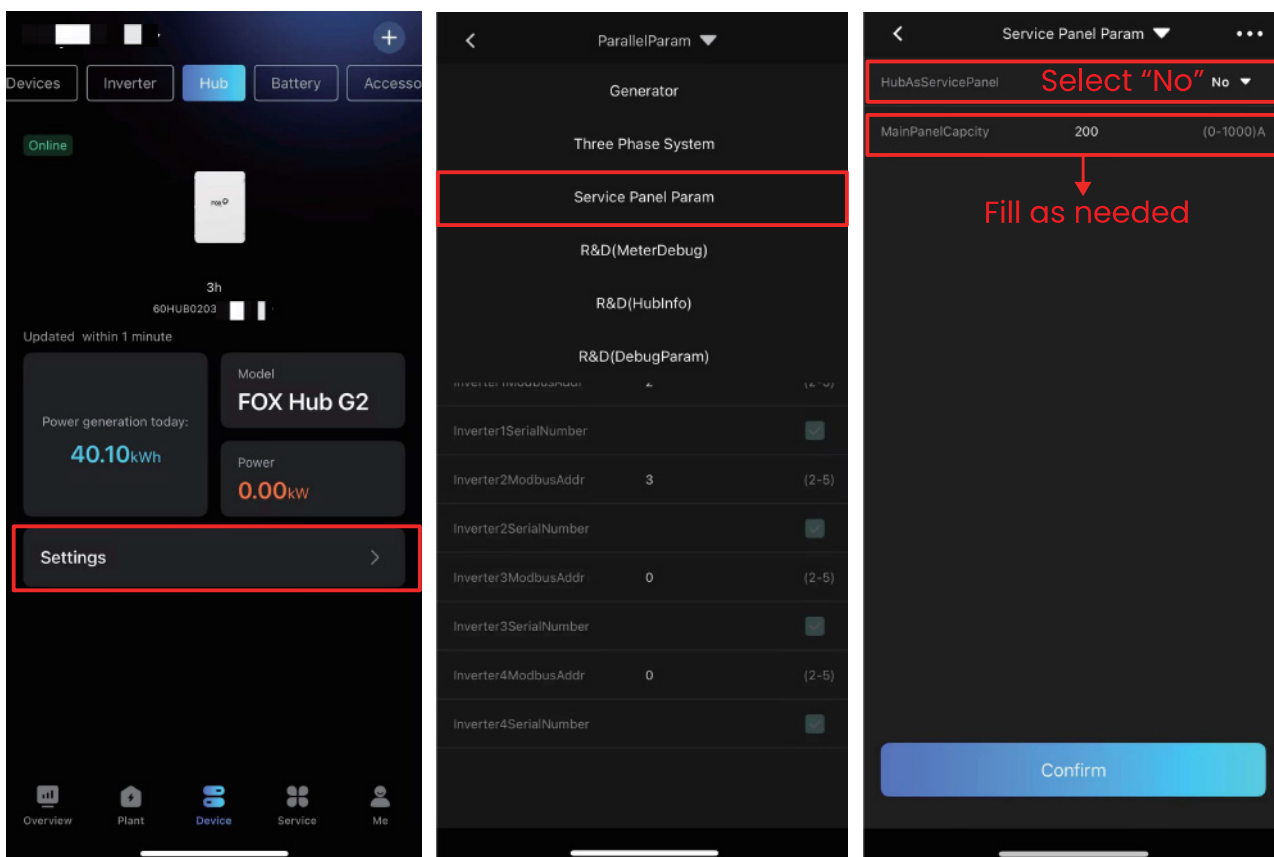

Item 5: Set the grid code on the **"Device"** dashboard.

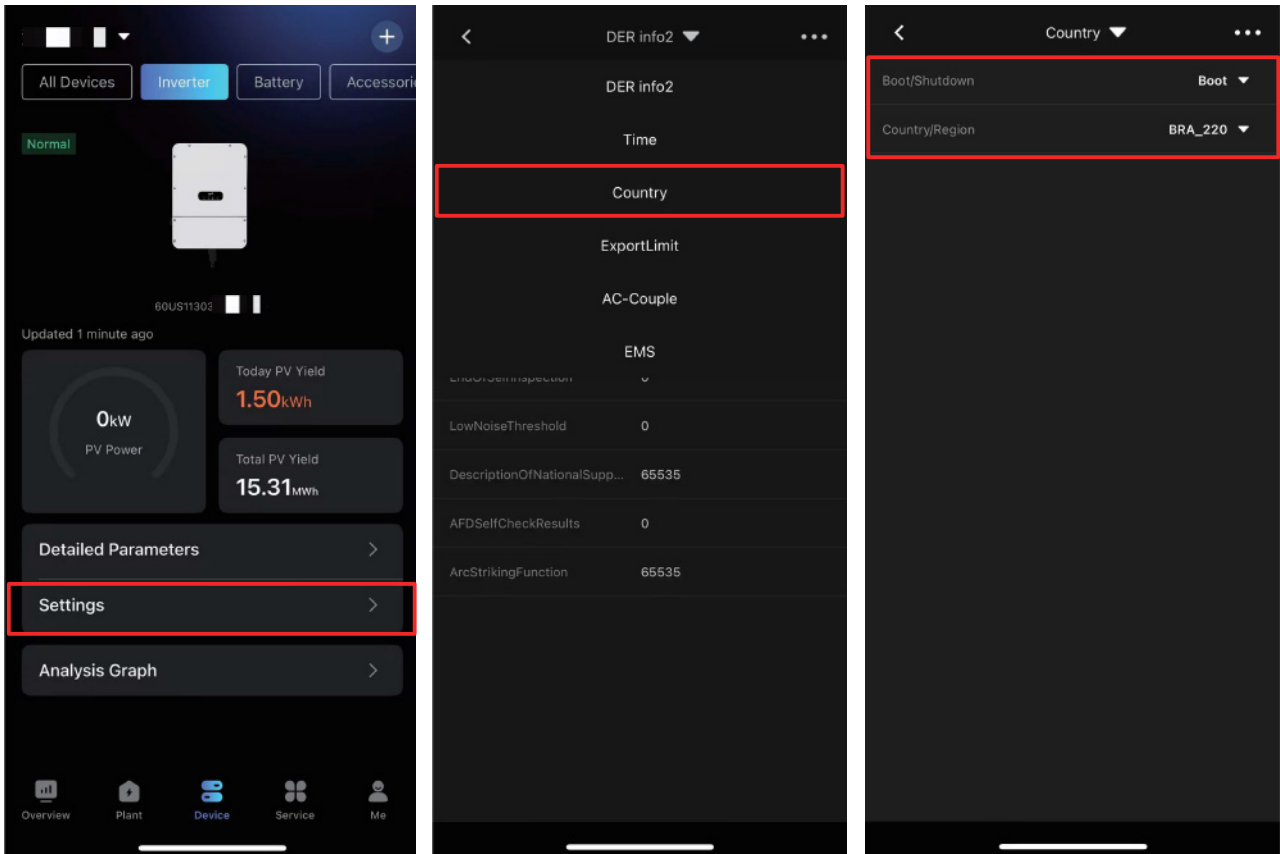

Item 6: Set the existing solar inverter power on the **"Device"** dashboard.

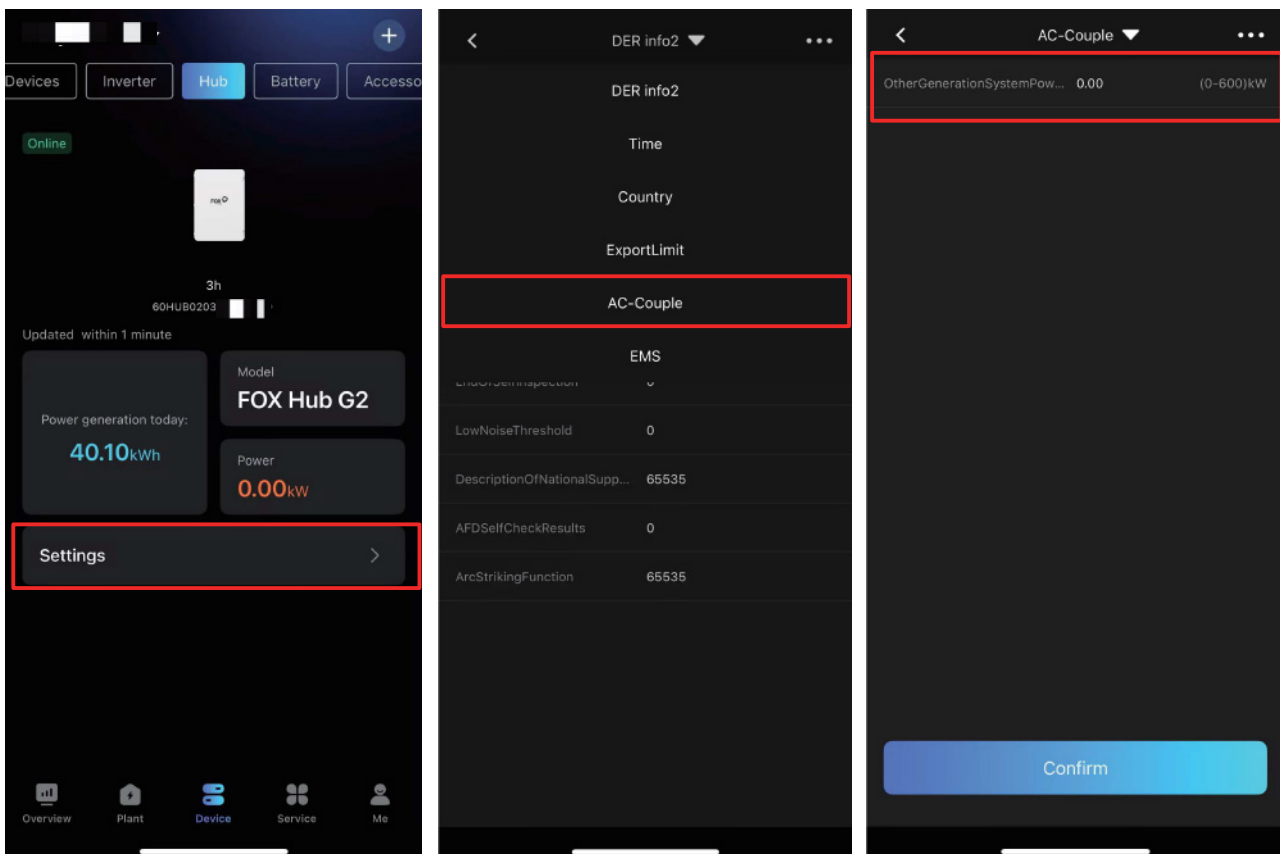

Item 7: Set the the charge by grid value on the **“Device”** dashboard.

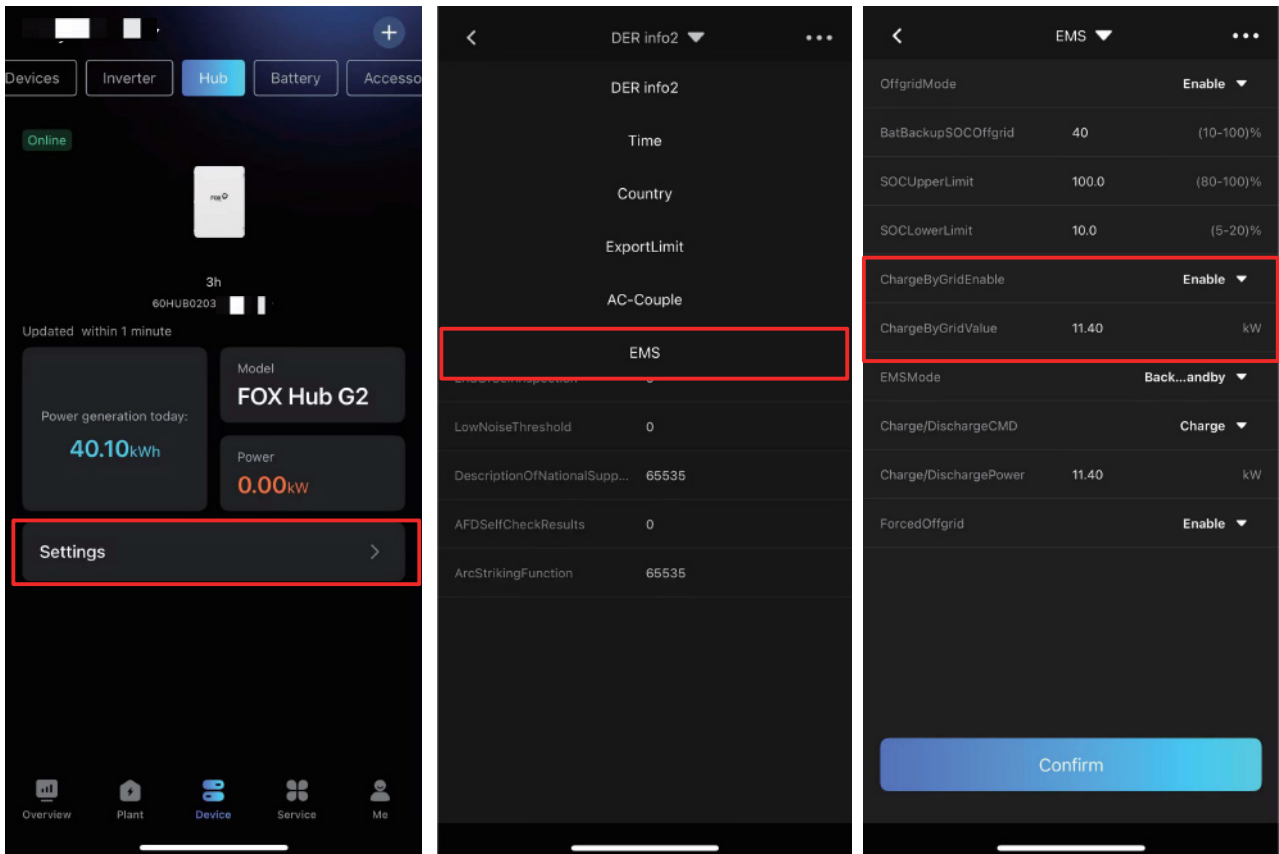

Item 8: Set the the parallel parameter on the **“Device”** dashboard.

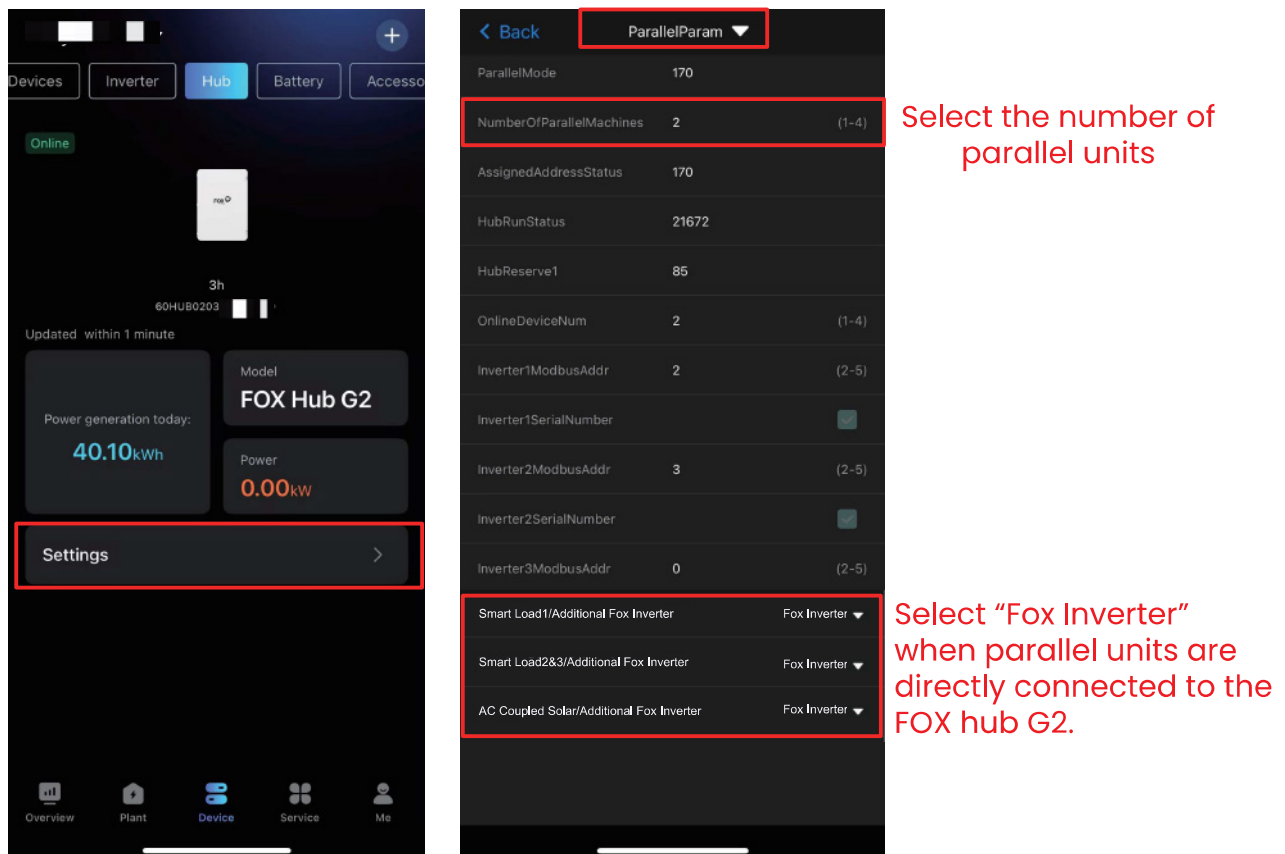

II Fox PowerQ Energy Storage System (without FOX Hub G2)

Notice

1. The information in this document may not be modified, copied or reproduced, in whole or in part, without the prior written permission of FOXESS CO., LTD. All information in this document is provided to the best of our knowledge and efforts, but does not constitute a warranty of any kind, express or implied. You can download quick guide and user manual by scanning the QR code.



2. Only certified electricians are allowed to operate the device. Operation personnel must wear proper personal protective equipment (PPE).
3. Before installing the device, check that the package contents are intact and complete against the packing list. If any damage is found or any component is missing, contact your dealer.
4. The device damage caused by the violation of instructions in this document is not covered under warranty.
5. The cable colors involved in this document are for reference only. Select cables in accordance with local cable specifications.
6. Fox PowerQ Energy Storage System has passed UL9540A unit level testing, suitable for residential indoor flooring installation

Testing Laboratory Name: CSA GROUP

Project Number: 80182817

Date of issue: April 2024

1 Packing List

1.1 Cube Inverter Package Box

Please refer to "1.1 Cube Inverter Package Box" on Page 1.

1.2 Battery Package Box

Please refer to 1.2 Battery Package Box on Page 2.

1.3 Accessories Package Box



A

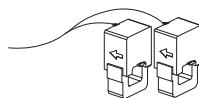

B

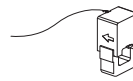

C

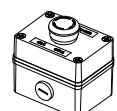

D

OBJ	QTY	DESC	OBJ	QTY	DESC
A	1	Smart WiLAN/Smart 4GWiLAN (Optional)	C	1	100A Current Transformer
B	2	250A Current Transformer	D	1	E-STOP

2 Required Tools

Please refer to “**Required Tools**” on pages 3 and 4.

3 Installation Steps

Please refer to “**Installation Steps**” on pages 4-7.

4 System Wiring Diagram

4.1 Whole-home Backup

Whole-home Backup (DC Couple)

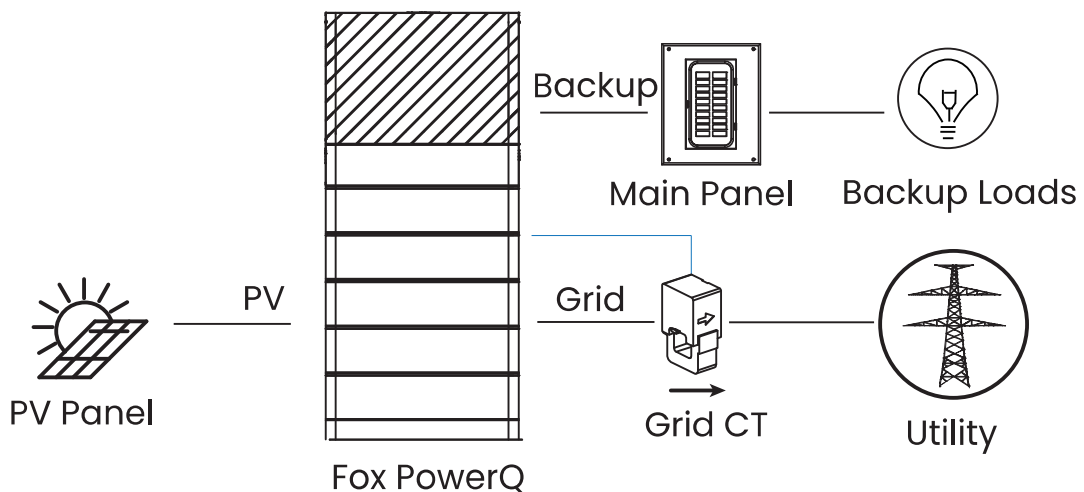
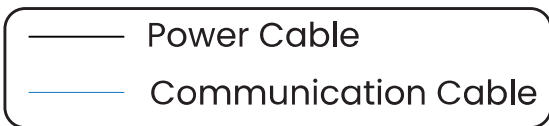

Whole-home Backup (AC Couple)

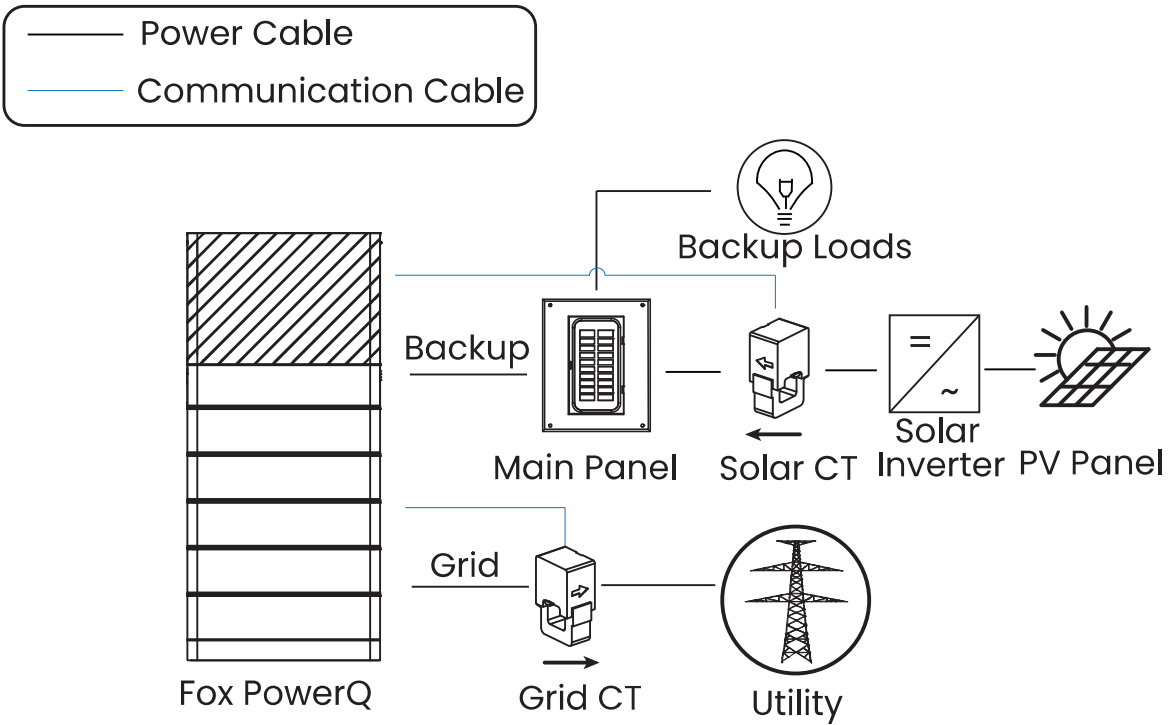

4.2 Partial-home Backup

Partial-home Backup (DC Couple)

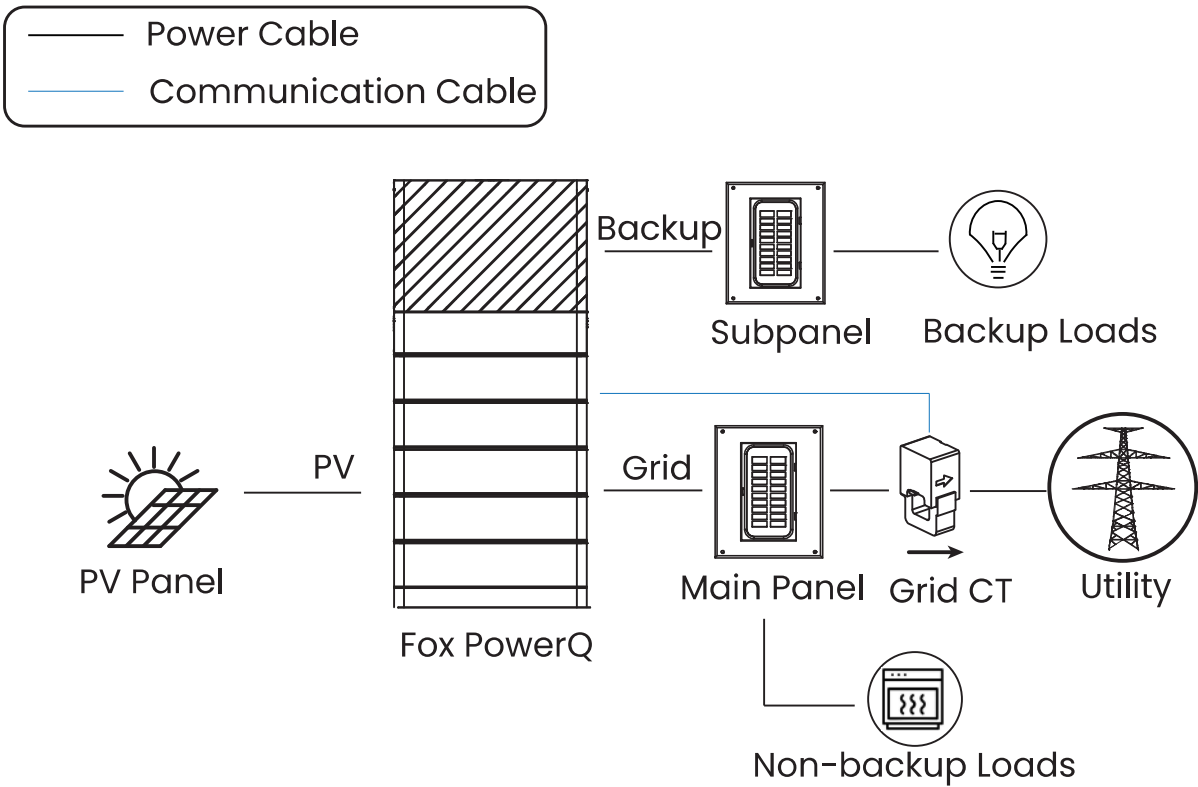

Partial-home Backup (AC Couple)

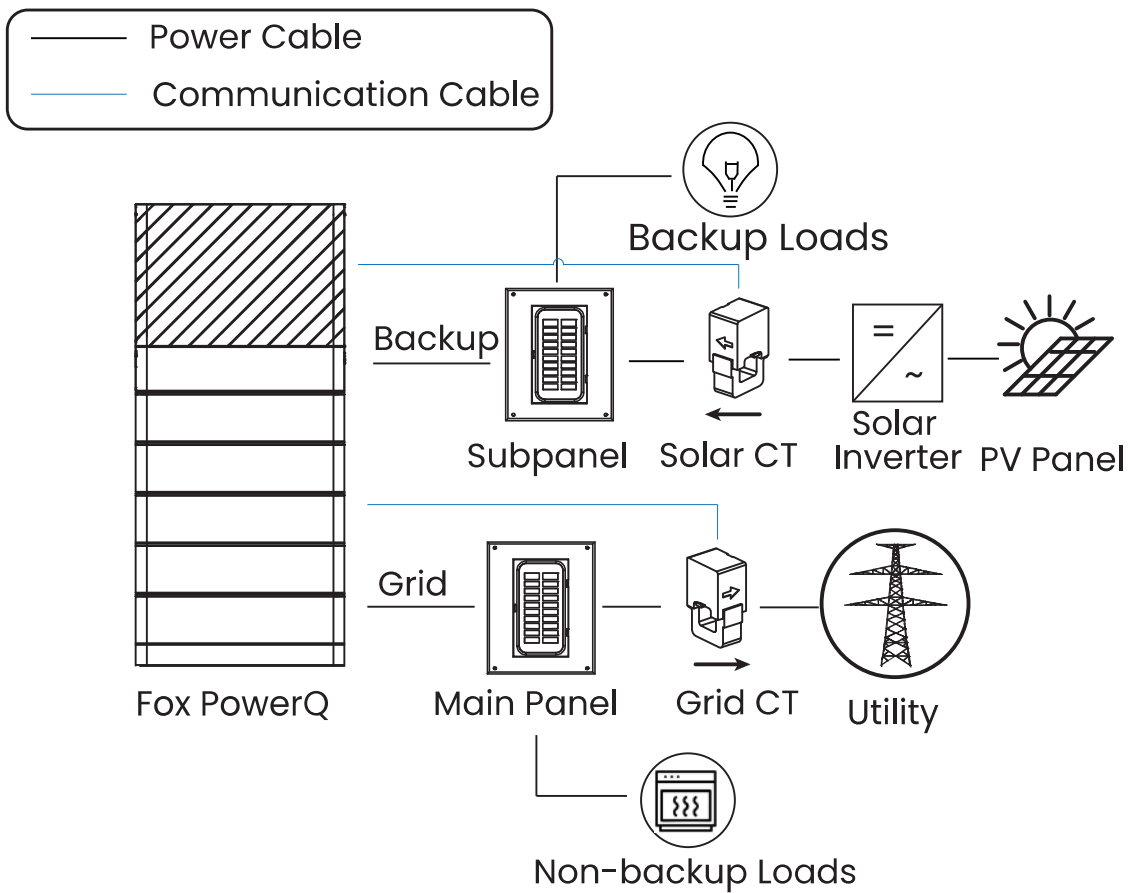

5 System Wiring Steps

5.1 Power Cable Wiring

- Size of Conduit and Cable Gland

Fox PowerQ			
Cable Marker	Max. Cable Diameter	Conduit	Gland
L1	6-2/0 AWG	EMT 2"	M75 or adapts to 2" EMT conduit
L2	6-2/0 AWG		
N	6-2/0 AWG		
PE	6-2/0 AWG		

- Recommended Routing: Through Bottom Cable Bridge, Then Into Interface

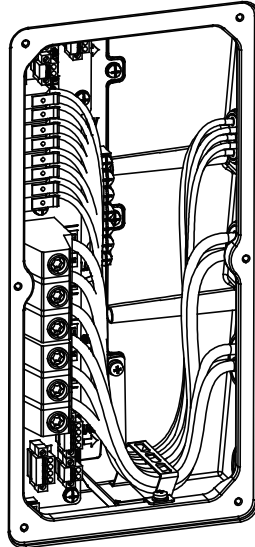

Fox PowerQ

- The PV Panels Connections to the Fox PowerQ
Turn off the DC switch before connection.

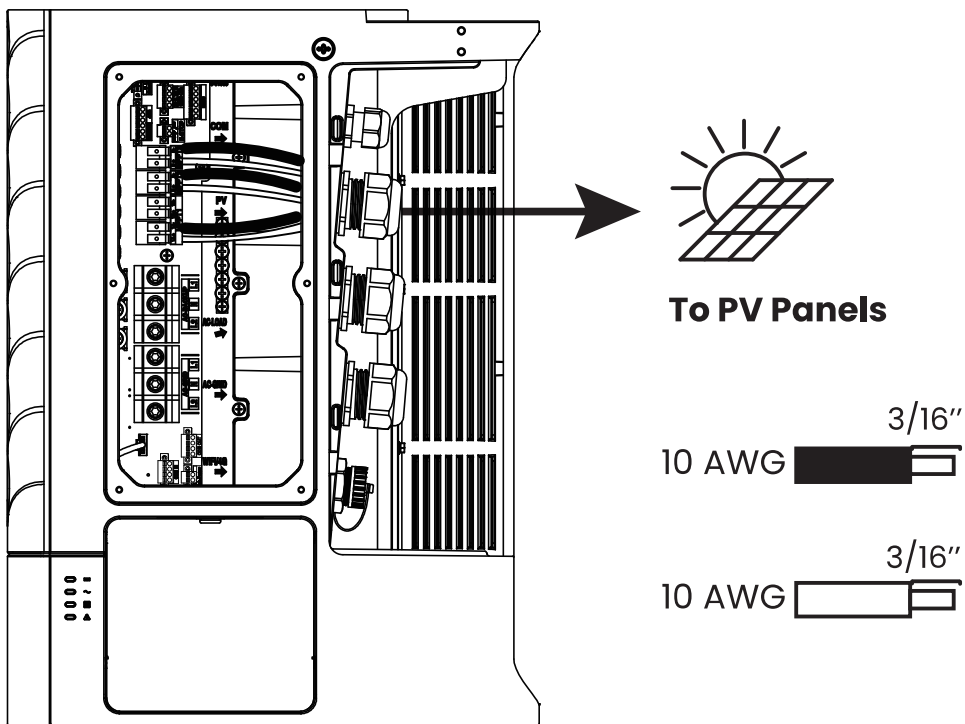

Fox PowerQ



-If there are ≤ 3 PV strings, 3 PV strings are preferentially connected to terminals 1A+, 1A-, 2+, 2-, 3+, 3-.

-If there are 4 PV strings, the number of PV panels connected to terminals 1A+, 1A- needs to be the same as that connected to terminals 1B+, 1B-.

• The Utility Connections to the Fox PowerQ

L1: 6-2/0 AWG  3/4"

N: 6-2/0 AWG  3/4"

L2: 6-2/0 AWG  3/4"

PE: 6-2/0 AWG  3/4"

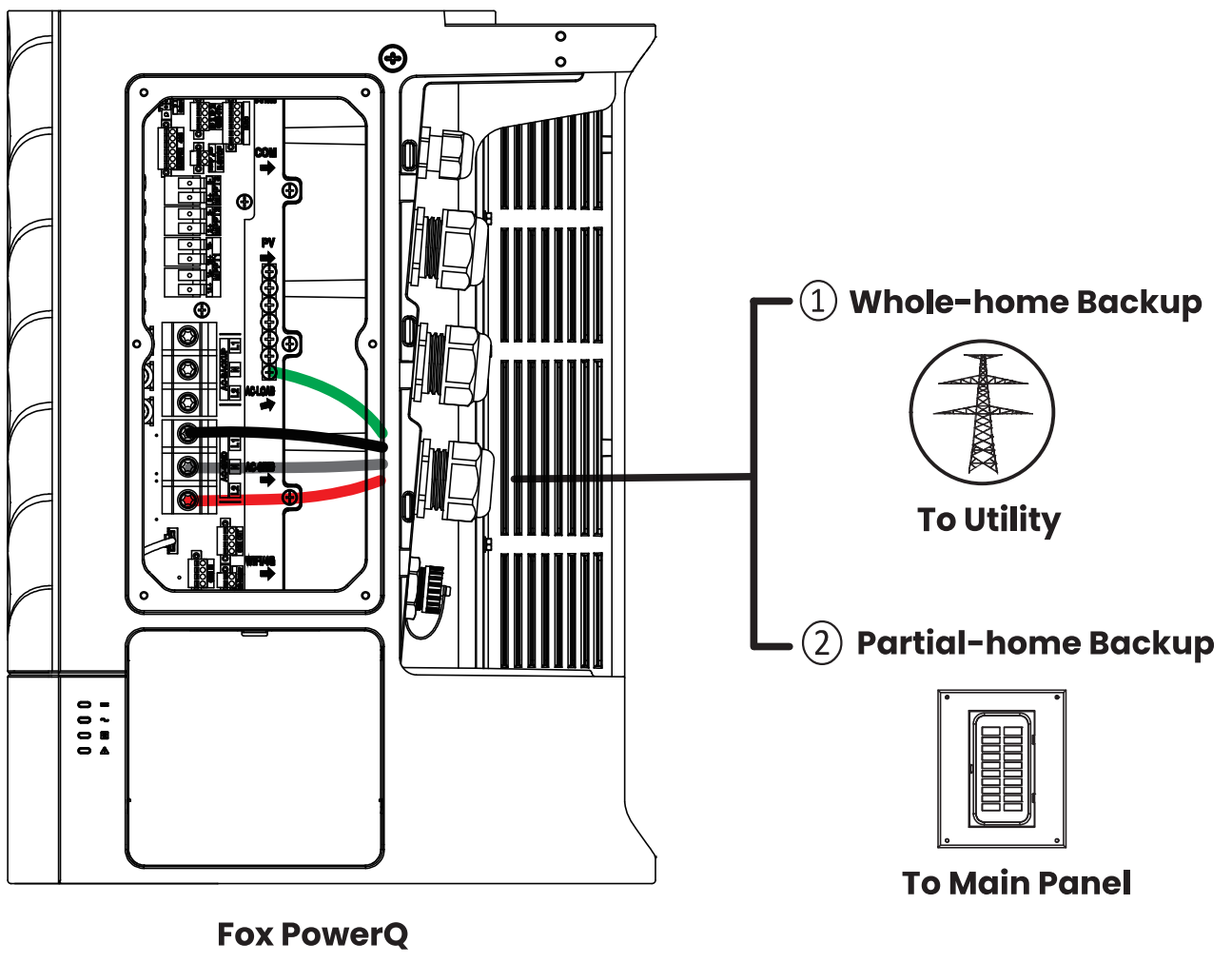

• The Backup Loads Connections to the Fox PowerQ

L1:
6-2/0 AWG  3/4"

N:
6-2/0 AWG  3/4"

L2:
6-2/0 AWG  3/4"

PE:
6-2/0 AWG  3/4"

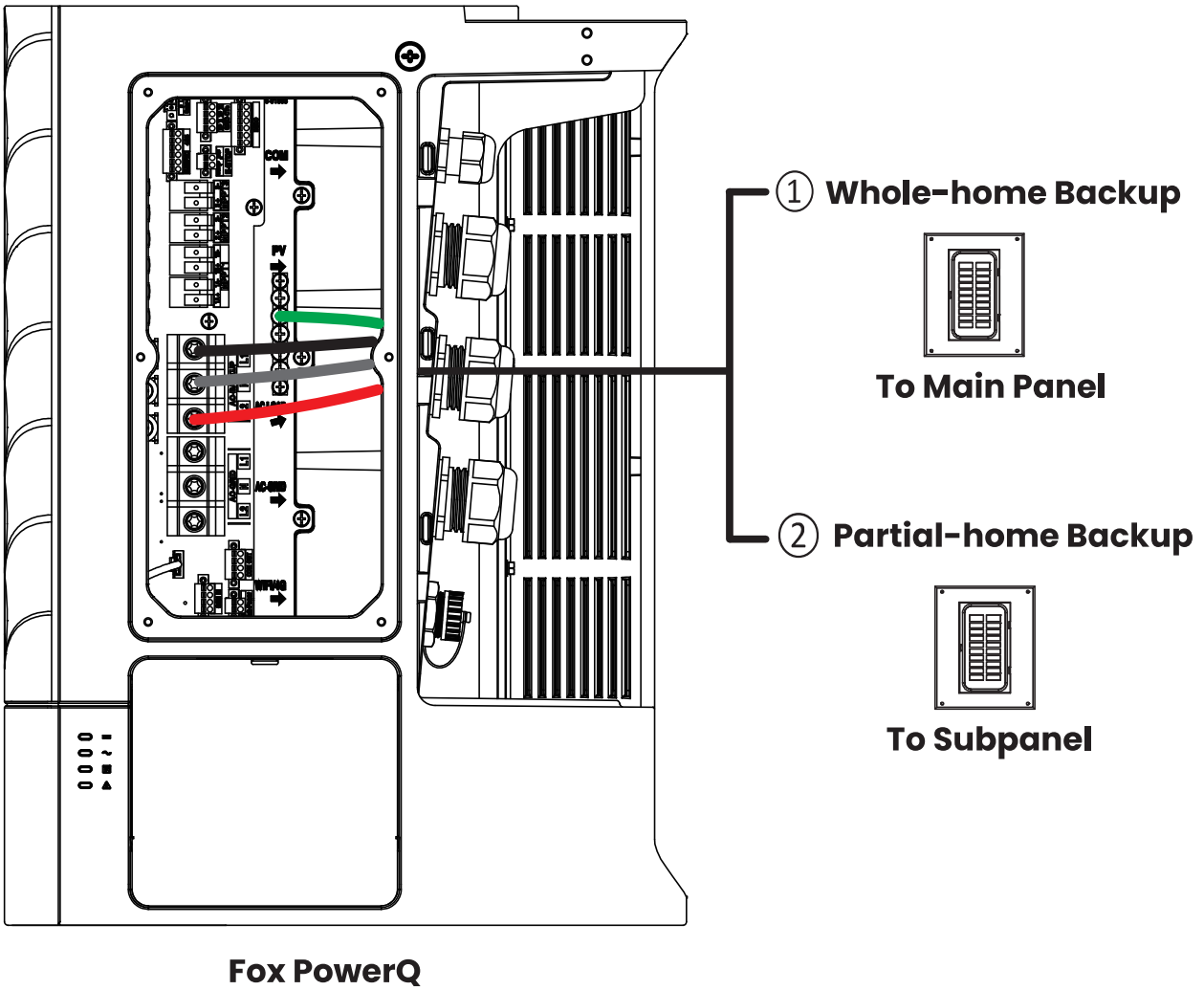

5.2 CT Wiring

- Grid CT Wiring

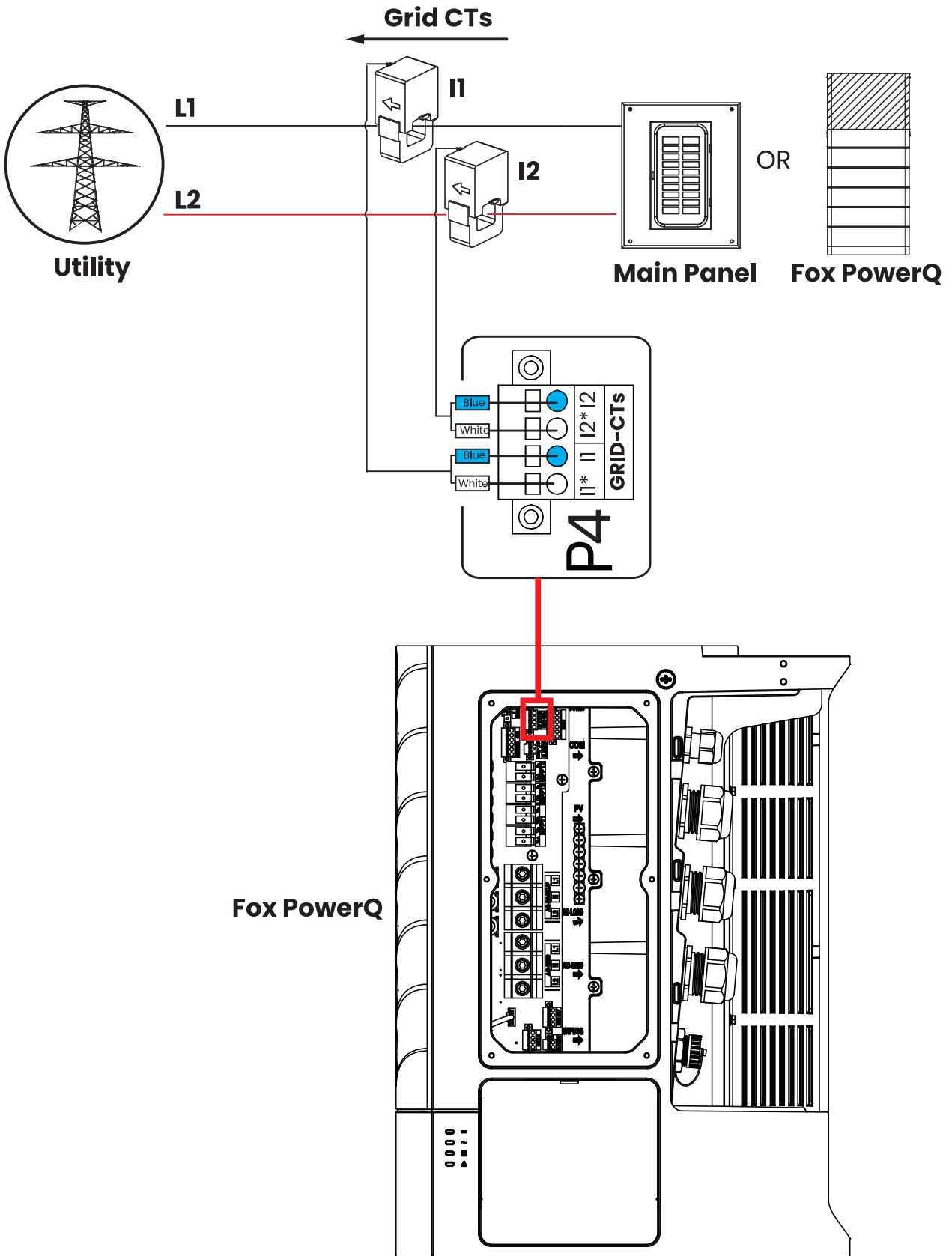

• Solar CT Wiring (Optional)

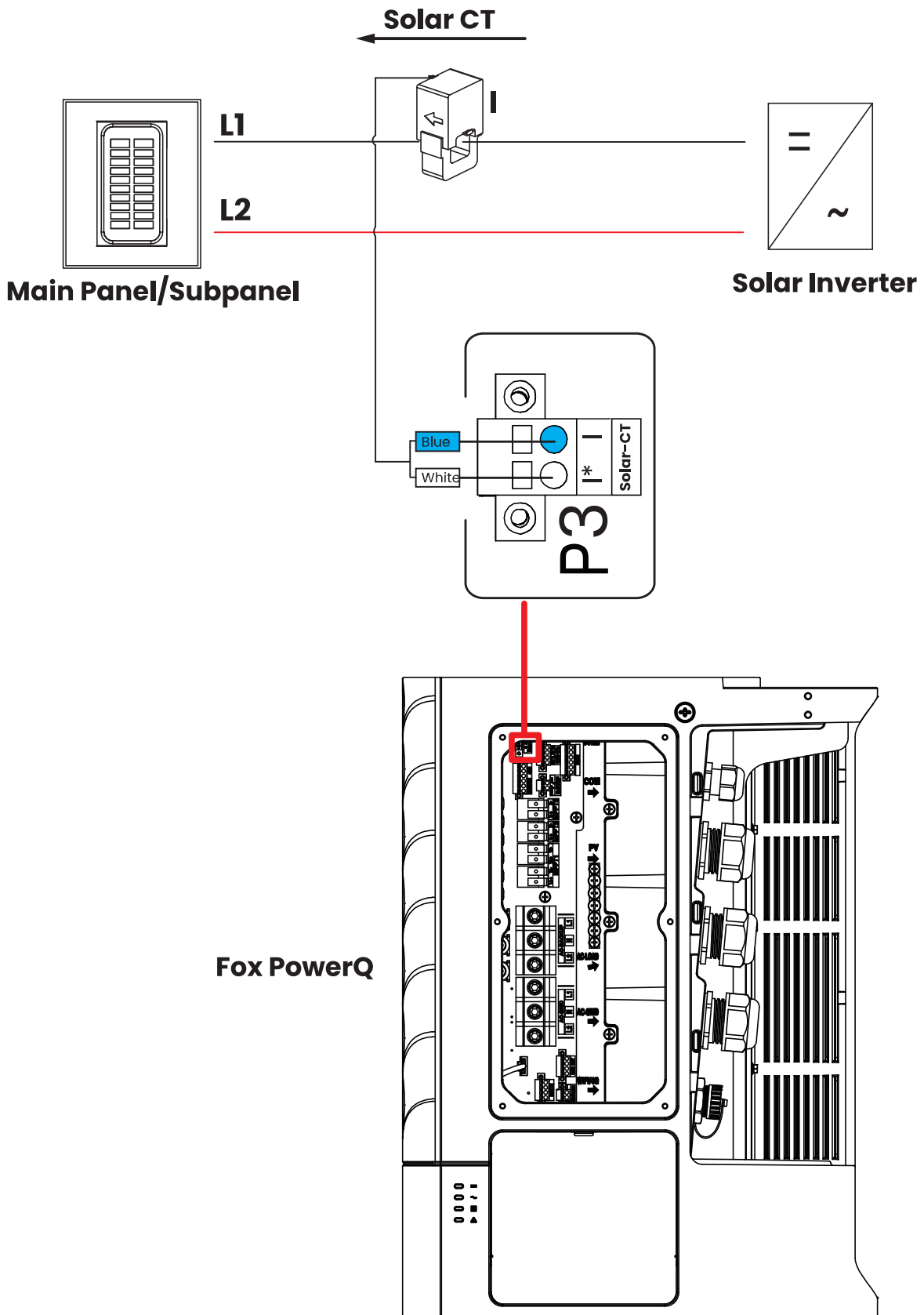

5.3 E-STOP Wiring

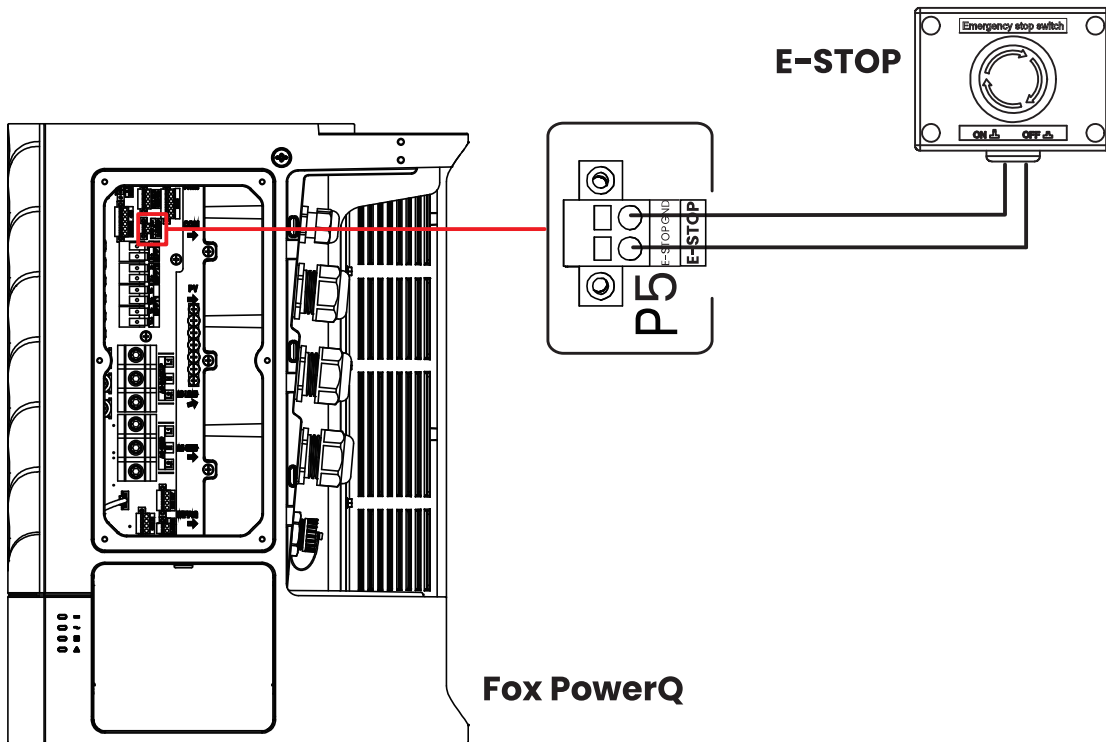

- Step 1: remove the jumper on the P5 socket.
Step 2: connect the P5 socket to the E-STOP.

 **NOTE:** Do not remove the jumper at the P5 socket if E-STOP is not used.

5.4 Smart WiLAN or Smart 4GWiLAN Connection

- **WiFi & 4G Installation:** connect the Smart WiLAN or Smart 4GWiLAN to the Fox PowerQ.

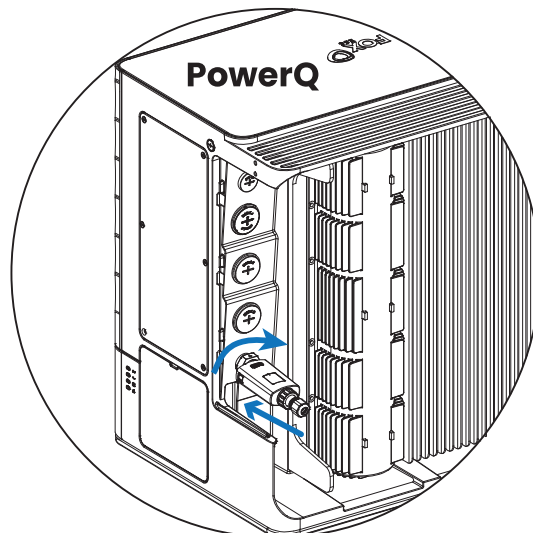

- **LAN Installation:** insert the network cable into the Smart WiLAN or Smart 4GWiLAN, and connect it to the Fox PowerQ.

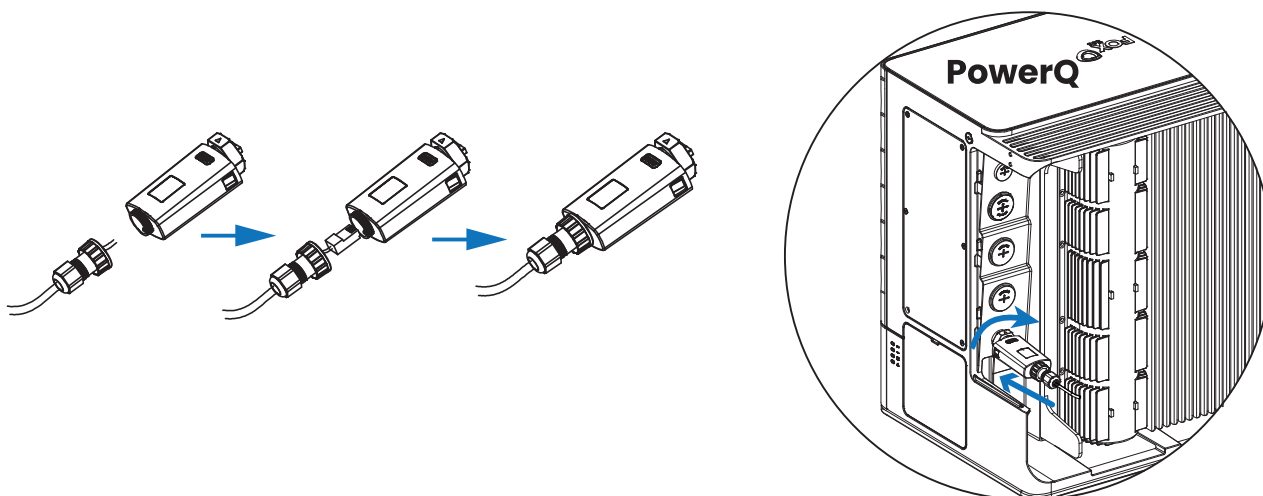

6 System Startup

Please refer to the following steps to switch on the system.

1. Ensure all cables are connected properly.
2. Turn on the PV SWITCH on the Fox PowerQ (Only for New System), and AC breakers (in main panel or service panel).
3. Turn on "BAT SWITCH" first, then press and hold "BAT POWER" button for 3s, and then release it.
4. Check if green lights on the Fox PowerQ are solid on.

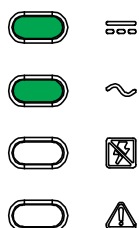
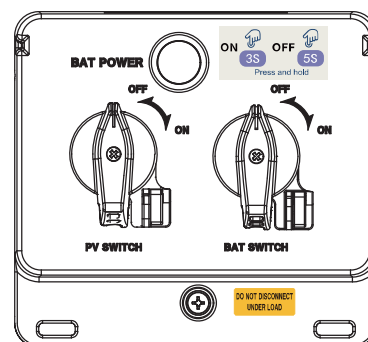

In case you need to turn off the system, please refer to the following steps:

1. Turn off the PV SWITCH, press and hold "BAT POWER" for 5s, and turn off "BAT SWITCH" and AC breakers.
2. Wait 5 minutes before you open the side cover of the Fox PowerQ (in case of repair).

Steps 1–5: refer to pages 40–45.

Step 6: Use the checklist below to make sure the necessary items are completed.

Item	Necessary or Optional	Status (✓ if completed)
1. Time Zone	Necessary	
2. Energy Mode	Necessary	
3. Service Panel Parameter	Necessary	
4. Initialization Setting	Necessary	
5. Zero Back-feed	Optional	
6. Grid Code	Optional (Only needed when selling to countries except US; Change "USA" into your own country)	
7. Existing Solar Inverter Power	Optional (Only needed in Existing System)	
8. Charge from Grid	Optional (Only needed when main breaker cannot support inverter output during full load)	

Item 1: Set up the time zone on the "Plant" dashboard.

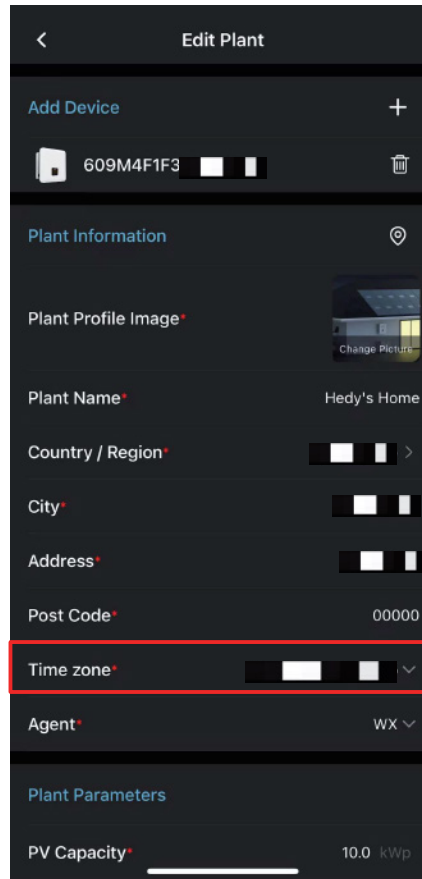

Item 2: Configure the energy management mode on the "Plant" dashboard.

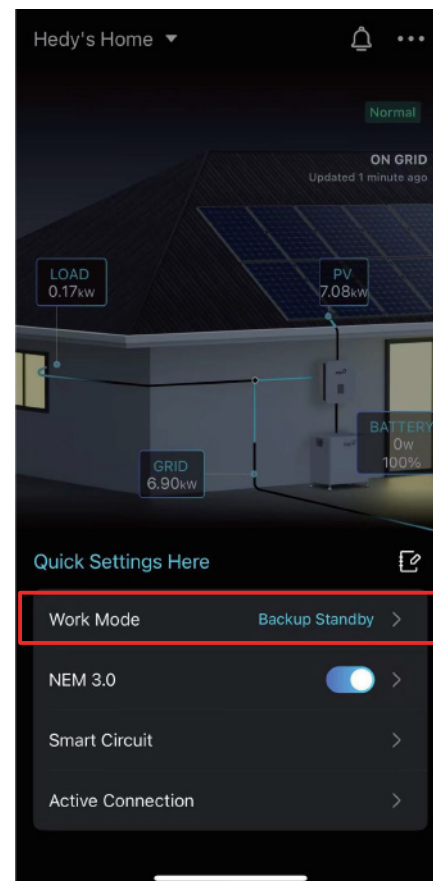
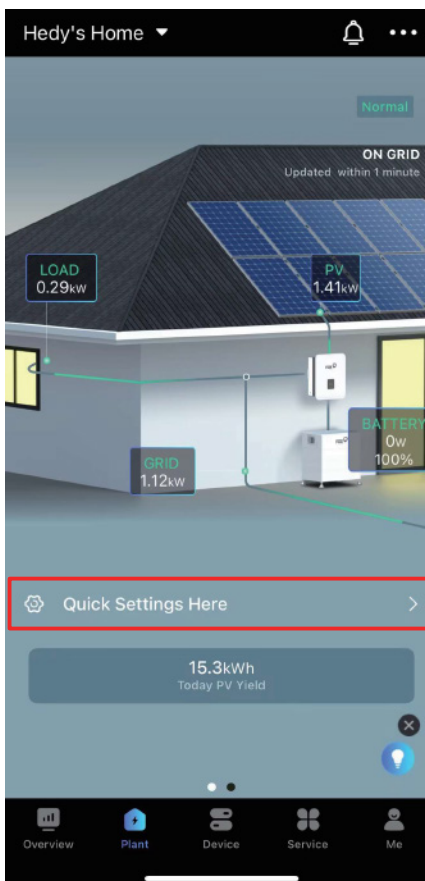

Item 3: Set service panel parameters on the “**Device**” dashboard.

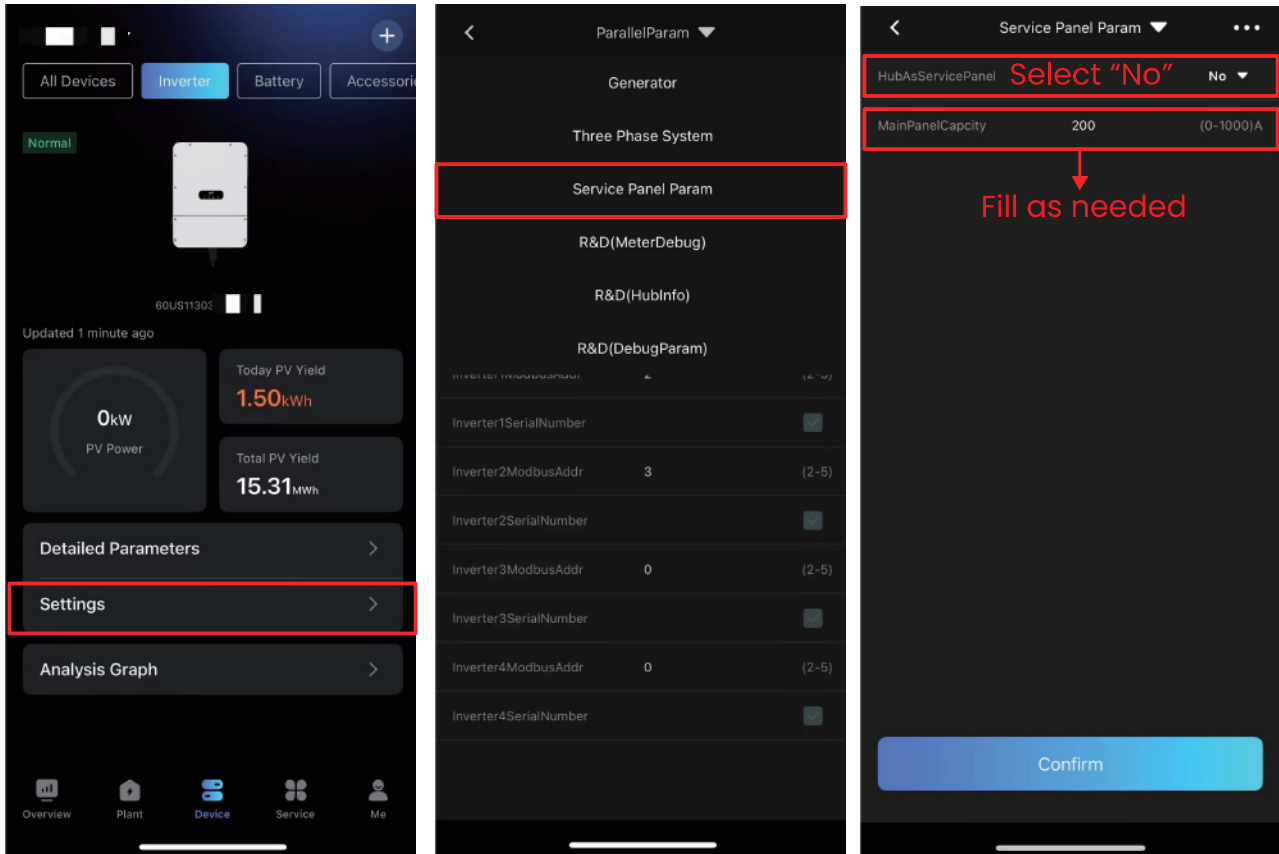

Item 4: Set initialization settings on the Device” dashboard.

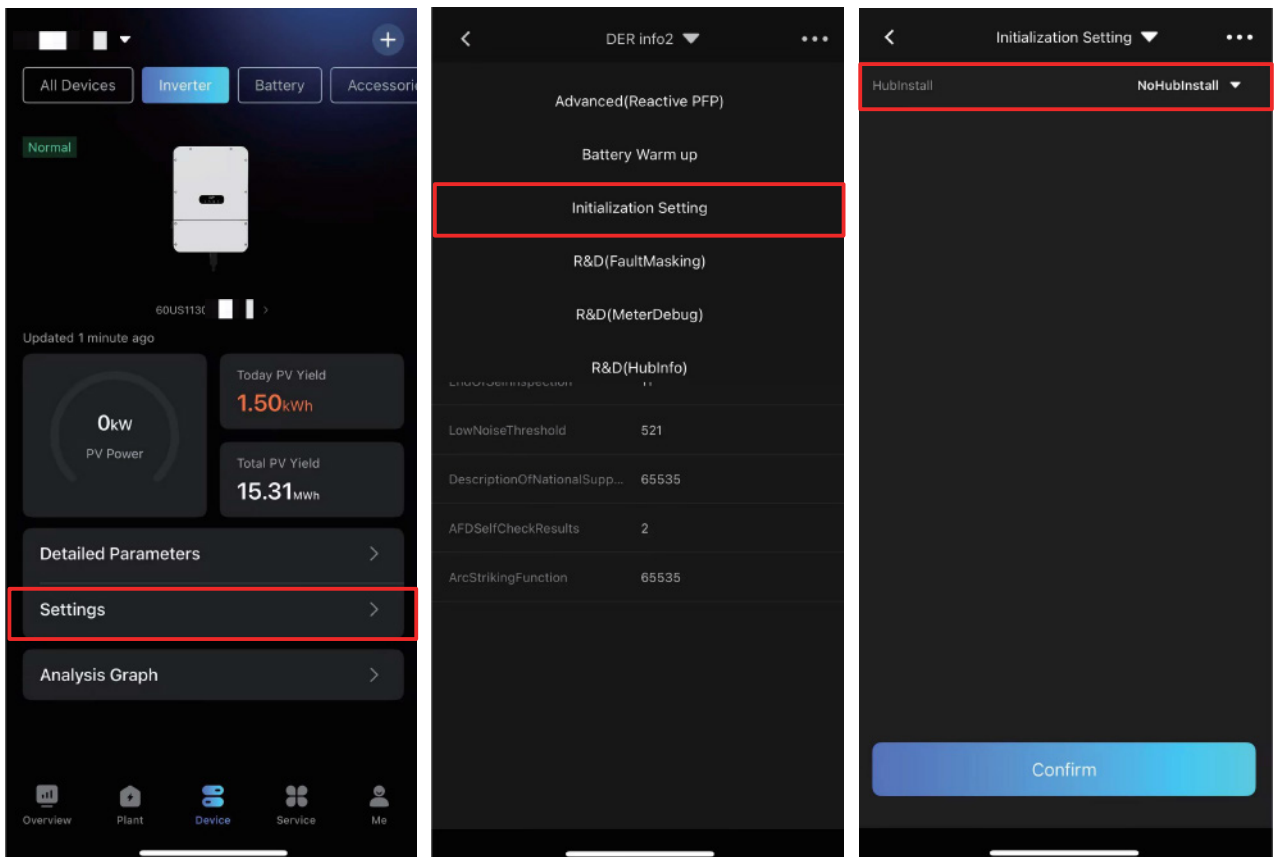

Item 5: Set the zero back-feed on the “**Device**” dashboard.

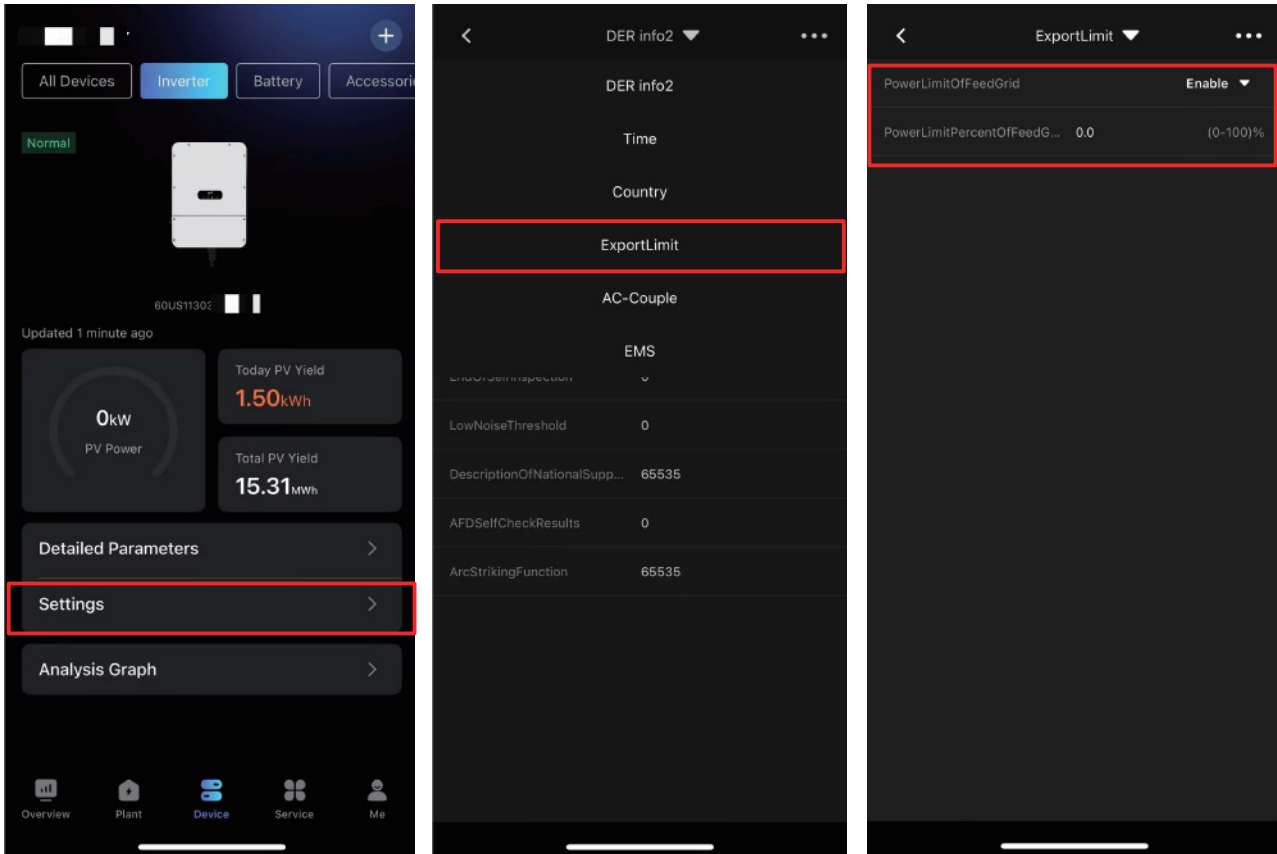

Item 6: Set the grid code on the “**Device**” dashboard.

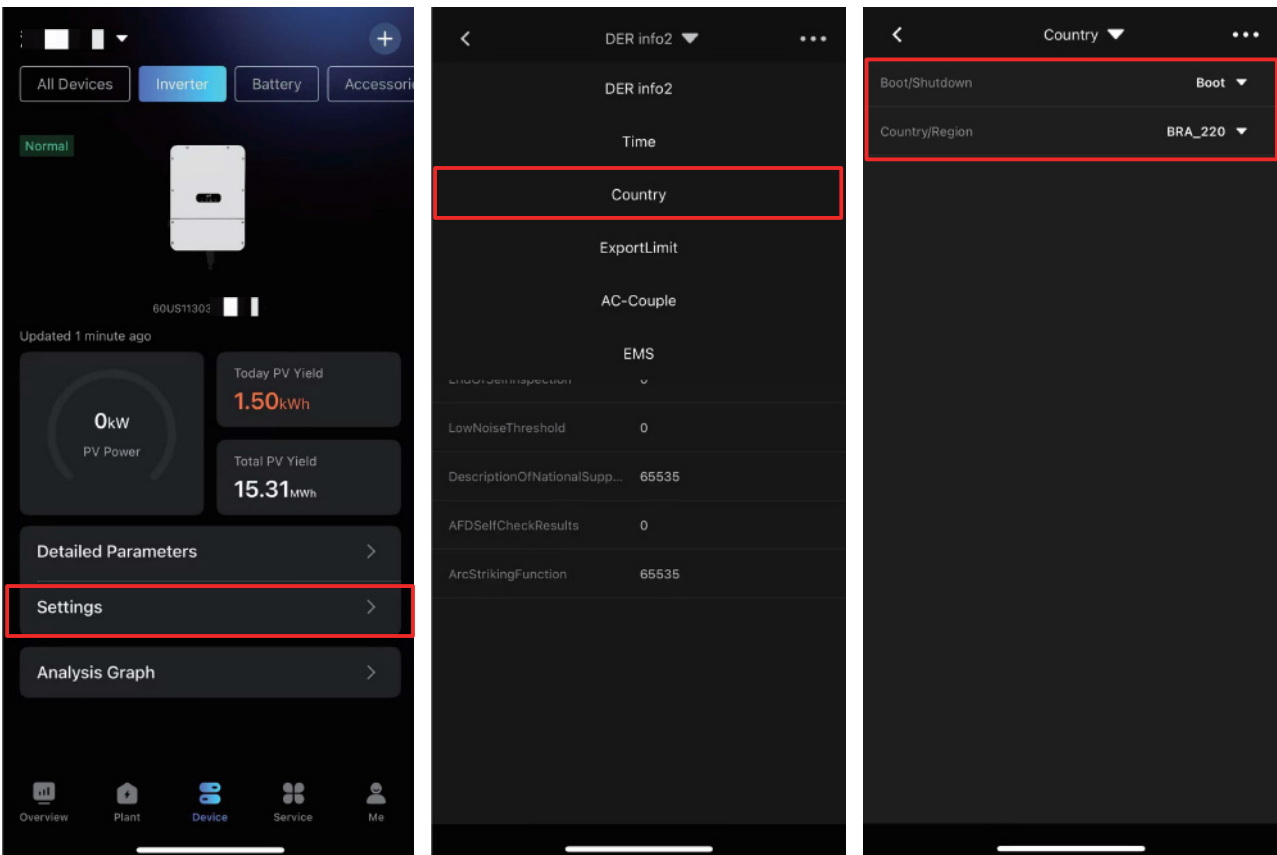

Item 7: Set the existing solar inverter power on the “**Device**” dashboard.

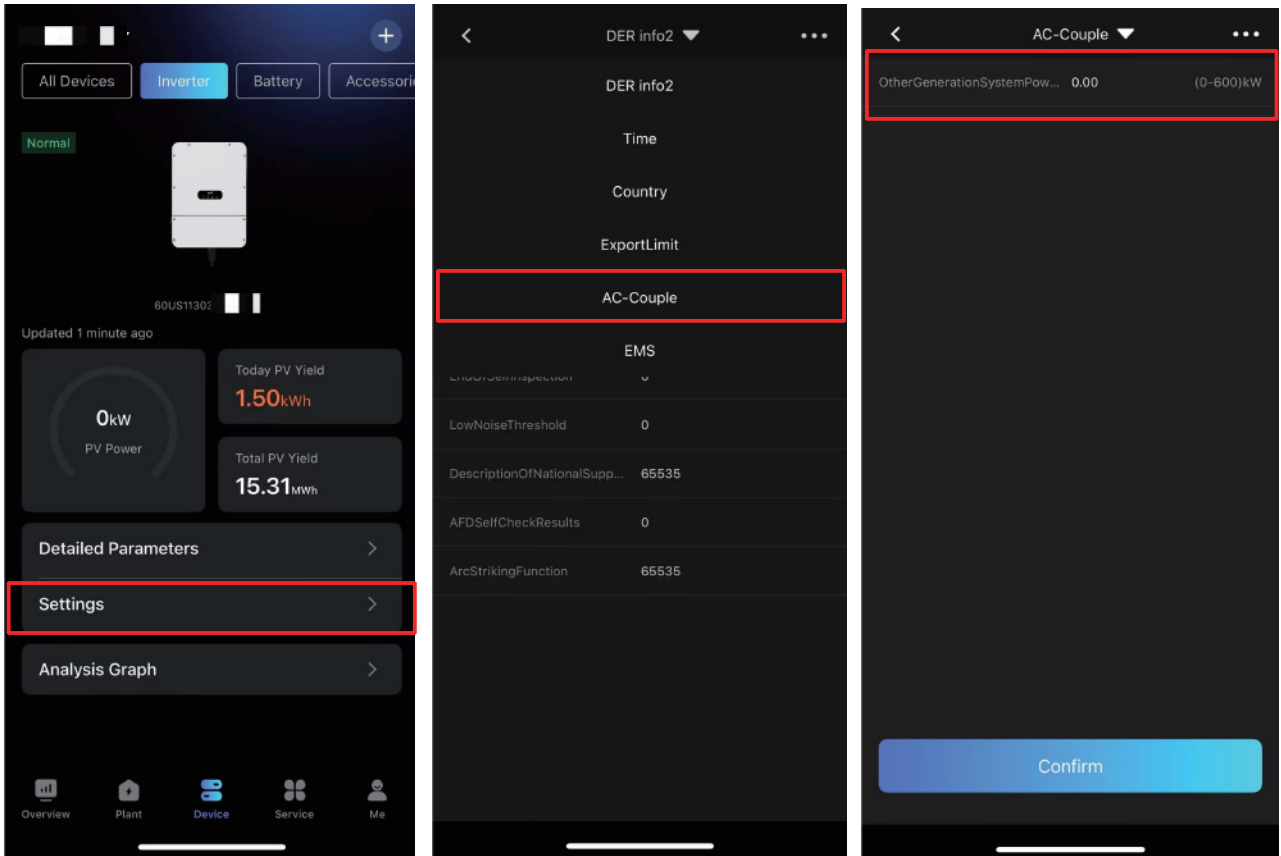

Item 8: Set the the charge by grid value on the “**Device**” dashboard.

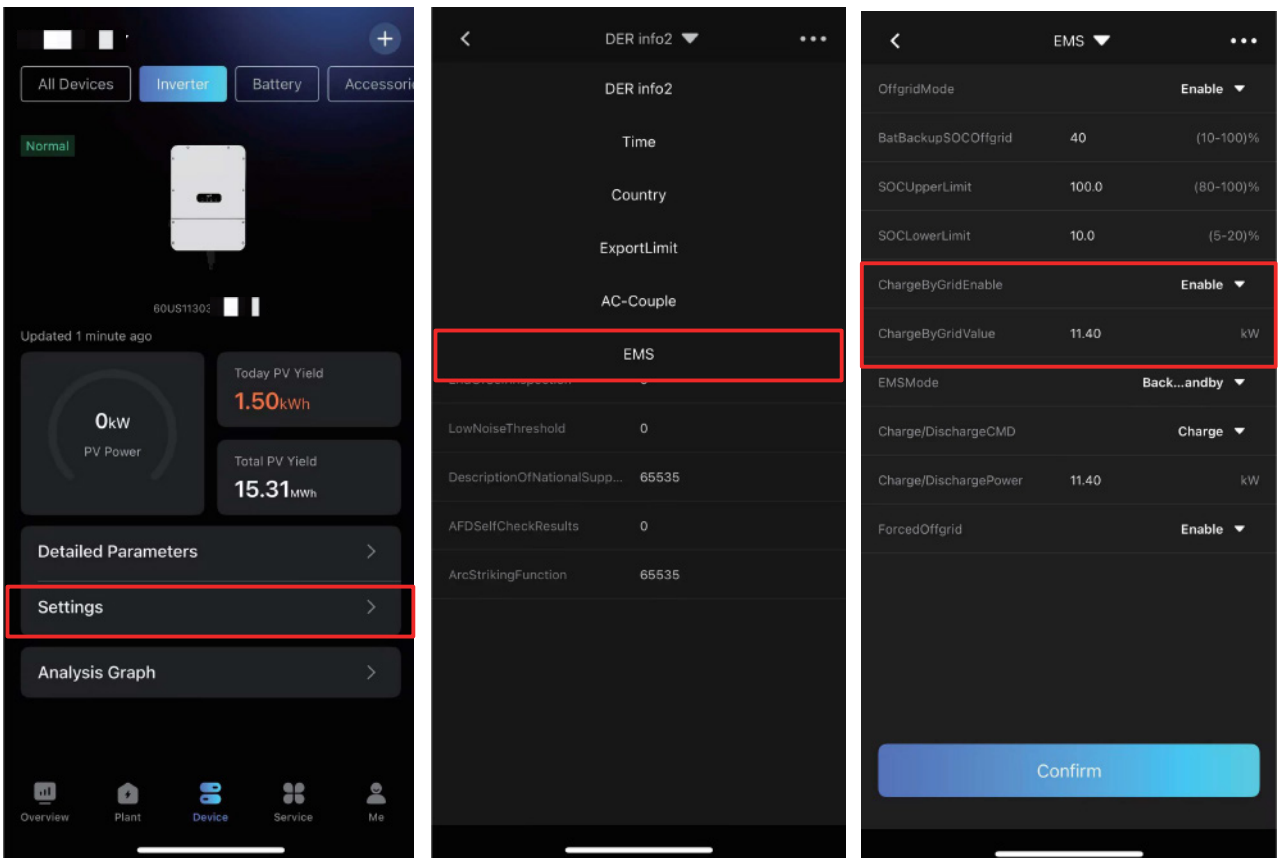



VI.1c

10-203-00589-01-X